

RAKO®

HOME

introducción

TRADICIÓN – marca europea- marca checa

LASSELSBERGER, s.r.o. es el único fabricante de azulejos cerámicos de la marca RAKO en la República Checa. Además, está entre los fabricantes más importantes en Europa. La famosa marca checa RAKO se enorgullece de una historia de más de 135 años, durante la cual se llevó a cabo una variada gama de obras de recubrimiento con azulejos cerámicos. Algunos ejemplos forman parte del patrimonio cultural, como por ejemplo el hotel Imperial o la Casa Municipal en Praga, la villa Tugendhat en Brno y muchas otras joyas arquitectónicas, admiradas hoy por todo el mundo. Los azulejos cerámicos RAKO son la base del éxito de la empresa LASSELSBERGER, s.r.o., gracias a su oferta de un surtido completo, su capacidad de innovación y su flexibilidad en la ejecución de pedidos, incluyendo reacciones rápidas a deseos extraordinarios de los clientes.

RAKO HOME – solución completa

RAKO HOME representa una gama completa de revestimientos y pavimentos con elementos decorativos y funcionales para ofrecer la solución completa para paredes suelos, baños, cocinas, interiores residenciales, balcones, terrazas y escaleras exteriores. RAKO HOME respeta el enfoque individual de cada cliente, se inspira en las tendencias actuales, manteniendo el equilibrio entre el diseño y los requisitos de calidad más exigentes. Nuestro permanente esfuerzo en mejorar la calidad nos permite producir productos, que basándose en modernos diseños y respetando últimas tecnologías de colocación, plenamente satisfacen los requisitos técnicos de los arquitectos y a la vez agradan a los usuarios. Las líneas actuales de RAKO nacen gracias a la última tecnología digital, de alta definición de impresión. La impresión digital permite transferir en alta definición cualquier tipo de diseño a las cerámicas con superficie lisa o con relieve. Con esta tecnología se consiguen además efectos naturales como imperfecciones, desgastes - pátinas, piedra cortada, o efectos de suelos de madera tradicionales. Series hechas con impresión digital están marcadas con el logo ❄️.

BAÑOS – diseño, estilo, calidad

Amplia gama de líneas para el cuarto de baño. Series de azulejo 20 x 40, 20 x 60, 30 x 60, 30 x 90 cm con las del pavimento permiten combinaciones únicas y personales a medida inspiradas con las últimas tendencias en estilos naturales o cosmopolitas

Pavimentos – calidad, diseño y funcionalidad

El programa de suelos presenta un gran surtido de azulejos esmaltados sinterizados hasta tamaños de 60 x 60 y 80 x 80 cm, 20 x 120 y 30 x 120 cm que aparte de su diseño se distingue por su alta calidad, funcionalidad, características técnicas y fácil mantenimiento.

SOLUCIONES PROFESIONALES – tecnología, sistema, garantía.

La oferta completa de RAKO cuenta con línea de productos químicos RAKO SYSTEM (www.rakosystem.eu) Es un sistema de productos y aplicaciones para todo el proceso de preparación, colocación, acabado, limpieza y mantenimiento de revestimientos y pavimentos cerámicos.

CALIDAD – control de productos en armonía con la naturaleza

A través de pruebas sistemáticas del producto, nos aseguramos de que en el momento de expedición cada producto cumpla con los criterios de calidad más estrictos. Alta calidad de productos RAKO el sistema de gestión de calidad y servicios de la normativa internacional ISO 9001. Las propiedades de los azulejos cerámicos cumplen con los requisitos de la norma EN 14411:2016. Diferentes certificados de renombrados institutos de certificación avalan nuestra calidad superior. Estos documentos se pueden descargar en www.rako.eu

Producción de productos aplicando la normativa internacional vigente sobre el cuidado del medioambiente gestionando la producción ecológica forma parte de la estrategia de la empresa. Con la declaración medioambiental de los productos según la normativa ISO 14 025, la empresa se compromete a cumplir con los requisitos de protección del medio ambiente. LASSELSBERGER, s.r.o. en el contexto de la protección del medio ambiente desarrolla permanente investigación y la continua inversión en el área del reciclaje de agua, eliminación ecológica de residuos, mejora de la calidad del aire y reducir la emisión de los gases liberados a la atmósfera en el proceso de la producción con el fin de lograr contaminación cero. Con respecto a la normativa utilizada en la producción utilizamos materias primas seleccionadas. El producto final lo embalamos en material reciclable.

SERVICIO – soporte para proyectos individuales

Unos productos de calidad superior y unos servicios profesionales son parte inseparable del éxito de una empresa. Por ello, en un marco de cooperación, ofrecemos asesoramiento opcional gratuito a proyectistas y arquitectos trabajando con nuestros productos. Un equipo profesional de proyectistas ayudará a nuestros clientes a asegurar una realización sin problemas de sus conceptos individuales. Los servicios comprenden asesoramiento técnico desde el principio de la realización hasta la finalización de las obras, así como la elección de materiales adecuados de RAKO SYSTEM según el tipo de inmueble, los planos de colocación y el cálculo de las cantidades necesarias de material, incluyendo referencias de detergentes profesionales recomendados para la limpieza final de superficies. Los datos de contacto del equipo proyectista están en www.rako.eu

PROPIEDAD INTELECTUAL E INDUSTRIAL

La estructura, diseño y forma de presentación de los elementos disponibles en el presente catálogo (gráficos, imágenes, fotografías, muestras y materiales que aparecen en los mismos, tecnologías industriales, logotipos, combinaciones de colores y cualquier elemento susceptible de protección) están protegidos por derechos de propiedad intelectual e industrial titularidad de LASSELSBERGER s.r.o. Está prohibida la reproducción, la transformación, distribución, comunicación pública, puesta a disposición del público y, en general, cualquier otra forma de explotación, parcial o total de los elementos referidos en el apartado anterior.

úvod

KVALITA – kontrola výrobků v souladu s přírodou

Průběžné a pravidelné zkoušky našich materiálů zaručují, že každý jednotlivý výrobek splňuje při expedici nejpřísnější kritéria kvality. Vysoká kvalita výrobků RAKO odpovídá systému řízení jakosti a služeb podle mezinárodní normy ISO 9001. Vlastnosti keramických obkladů splňují požadavky normy EN 14411:2016. Prvotřídní kvalitu potvrzují certifikáty renomovaných zkušebních ústavů. Dokumenty najdete ke stažení na www.rako.cz

Součástí firemní strategie je produkce ekologicky šetrných výrobků, která dodržuje platné národní i mezinárodní normy a využívá systém řízení ohleduplný k životnímu prostředí. Vydáním environmentálního prohlášení o produktu podle ISO 14 025 se společnost zavázala, že bude plnit požadavky na ochranu životního prostředí. Společnost LASSELSBERGER, s.r.o. v rámci ochrany životního prostředí provádí kontinuální výzkum a vynakládá značné investice na recyklaci vody, ekologickou likvidaci odpadů, zlepšení kvality ovzduší a snižování koncentrace plynů uvolňovaných do ovzduší s cílem dosáhnout nulového znečištění. S ohledem na platné předpisy používáme při výrobě vybrané suroviny a finální produkty balíme do obalů vhodných k recyklaci.

SERVIS – otevřenost pro individuální projekty

Kvalitní produkty a kompetentní služby jsou pro úspěchy v podnikání spjité nádoby. V rámci partnerské spolupráce proto nabízíme projektantům a architektům, kteří pracují s našimi výrobky, že mohou využít bezplatný poradenský servis. Vyškolený tým projektových specialistů pomáhá našim zákazníkům zajistit bezproblémovou realizaci jejich individuálních konceptů. K poskytovaným službám patří technické poradenství od počátku samotné realizace až po dokončení zakázky, které zahrnuje výběr vhodných materiálů a stavební chemie RAKO SYSTEM podle jednotlivých objektů, kladečské plány a výpočet potřebného množství materiálů včetně doporučení profesionálních čistících prostředků pro finální úklid povrchů. Kontakty na projektový tým najdete na www.rako.cz

RAKO HOME – vše z jedné ruky

Značka RAKO HOME představuje bohatý sortiment keramických obkládaček a dlaždic včetně dekorativních a funkčních doplňků pro kompletní dotvoření stěn a podlah koupelen a kuchyní i dalších bytových interiérů, jakož i balkonů, teras a schodišť v exteriéru. RAKO HOME zachovává individuální přístup k zákazníkovi, čerpá inspiraci ze současných trendů a zároveň udržuje soulad mezi rafinovaností designu a náročnými požadavky na kvalitu. Naše trvalá snaha o zlepšování nám dovoluje vytvořit špičkové série s ohledem na design a moderní technologii pokládky, schopné uspokojit technické požadavky architektů a zároveň vyhovět vkusu koncových zákazníků. Současné série RAKO vznikají na základě nejmodernější digitální technologie HD Print. Pomocí digitálního tisku lze přenést na hladký i reliéfní povrch keramiky jakýkoliv dekor ve vysokém rozlišení. Daří se tak vytvořit autentické přírodní nahodilosti, nedokonalosti, patinu, řez kamenem nebo či běžné úpravy povrchů dřevěných podlah. Série vyrobené digitálním tiskem mají v katalogu logo: ❄️.

KOUPELNY – nadčasovost, styl, luxus

Kolekce koupelnového programu kombinuje nadčasové i moderní série obkládaček zejména ve formátech 20 x 40, 20 x 60, 30 x 60, 30 x 90 cm a dlaždic pro osobitá řešení „na míru“, inspirovaná aktuálními trendy, přírodou i luxusní atmosférou.

PODLAHY – funkčnost, kvalita, design

Podlahový program představuje pestrou nabídku slintutých glazovaných dlaždic až do formátů 60 x 60 a 80 x 80 cm, 20 x 120 a 30 x 120 cm toto, která vyniká kromě designu vysokou kvalitou, funkčností, dokonalými technickými vlastnostmi a snadnou údržbou.

PROFESIONÁLNÍ ŘEŠENÍ – systém, garance, technologie

Komplexní nabídku značky RAKO doplňuje speciální stavební chemie značky RAKO SYSTEM (www.rakosystem.cz) pro systémové aplikace v oblasti přípravy podkladu a lepení, spárování, čištění i údržby.

TRADICE – česká značka

LASSELSBERGER, s.r.o. je jediným výrobcem keramických obkladů, značky RAKO, v Česku a zároveň patří mezi nejvýznamnější výrobce v Evropě. Tradiční česká značka RAKO slaví v letošním roce 135. výročí. V průběhu dlouhých let vznikla pestrá paleta realizací vytvořených z keramických obkladů. Některé z nich jsou neoddělitelnou součástí českého kulturního dědictví například hotel Imperial nebo Obecní dům v Praze, vila Tugendhat v Brně a mnoho dalších stavitelských skvostů, které dnes obdivuje celý svět. Keramické obklady RAKO jsou základem úspěchu firmy LASSELSBERGER, s.r.o., a to díky nabídce kompletního sortimentu, inovačním schopnostem a pružnosti ve vyřizování zakázek včetně rychlých reakcí na mimořádná přání zákazníků.

RAKO HOME – wszystko z jednej ręki

Marka RAKO HOME reprezentuje bogaty asortyment płytek ceramicznych i gresu, łącznie z dodatkami dekoracyjnymi i funkcjonalnymi do kompletnego wykańczania ścian i podłóg w łazienkach, kuchniach i innych pomieszczeniach, również na balkonach, tarasach i schodach na zewnątrz. RAKO HOME respektuje indywidualne podejście do klienta, czerpie inspirację ze współczesnych trendów i jednocześnie zachowuje harmonię między wyrafinowanym wzornictwem i wysokimi wymaganiami. Efektem naszego nieustannego dążenia do doskonałości są najwyższej jakości serie z punktu widzenia wzornictwa i nowoczesnej technologii, potrafiące zaspokoić wymagania techniczne architektów oraz zadowalające gusta klientów. Obecnie, serie RAKO powstają dzięki najnowocześniejszej technice cyfrowego druku HD. Druk cyfrowy pozwala przenieść, na gładką lub reliefową powierzchnię ceramiki, jakiegokolwiek wzór w wysokiej rozdzielczości. Można odtworzyć autentycznie wyglądające, naturalne różnice, niedoskonałości, patynę, przekroju kamienia, czy różne rodzaje powierzchni drewnianych podłóg. Serie wykonane drukiem cyfrowym oznaczone są w katalogu logo: ☼.

ŁAZIENKI – ponadczasowość, styl, luksus

Bogata kolekcja programu łazienkowego optymalnie komponuje się z ponadczasowymi i nowoczesnymi seriami płytek 20 x 40, 20 x 60, 30 x 60, 30 x 90 cm i gresu, dopasowanymi do indywidualnych rozwiązań „na miarę” inspirowanych aktualnymi trendami, przyrodą i luksusową atmosferą.

PODŁOGI – funkcjonalność, jakość, estetyka

Program podłogowy przedstawia urozmaiconą ofertę szklwionych płytek gresowych aż po formaty 60 x 60 i 80 x 80 cm, 20 x 120 i 30 x 120 cm, która wyróżnia się – oprócz designu – wysoką jakością, funkcjonalnością, doskonałymi właściwościami technicznymi i łatwym utrzymaniem czystości.

PROFESJONALNE ROZWIĄZANIE – system, gwarancje, technologie

Kompleksową ofertę RAKO dopełnia specjalna chemia budowlana marki RAKO SYSTEM (www.rakosystem.eu) do systemowych aplikacji w zakresie przygotowania podłoża i klejenia, fugowania, czyszczenia i utrzymania.

JAKOŚĆ – kontrola wyrobów zgodnie z przyrodą

Systematycznymi kontrolami wyrobów zapewniamy, że każdy pojedynczy wyrób spełnia w chwili obrotu najbardziej surowe kryteria jakości. Wysoka jakość wyrobów RAKO odpowiada systemowi zarządzania jakością i usługami, zgodnie z międzynarodową normą ISO 9001. Właściwości płytek ceramicznych spełniają też wymagania normy EN 14411:2016. Certyfikaty renomowanych instytucji badawczych dokumentują pierwszorzędą jakość. Dokumenty można pobrać na stronie www.rako.eu

Częścią strategii firmowej jest produkcja przyjaznych ekologicznie wyrobów, która spełnia wymagania obowiązujących norm krajowych i międzynarodowych i wykorzystuje system zarządzania przyjaznego dla środowiska. Wydając deklarację środowiskową o produkcie, według normy ISO 14025, spółka zobowiązuje się do spełniania wymagań dotyczących ochrony środowiska. Spółka LASSELSBERGER, s.r.o. w ramach ochrony środowiska nieustannie prowadzi badania oraz inwestuje w recykling wody, ekologiczną likwidację odpadów, poprawę jakości atmosfery i obniżanie ilości gazów wypuszczanych do atmosfery w celu osiągnięcia zerowego zanieczyszczenia. Zgodnie z obowiązującymi przepisami w produkcji stosujemy wybrane surowce, a produkty finalne pakujemy do przetworzonych opakowań.

SERWIS – otwartość na indywidualne projekty

Jakość produktów i kompetentny serwis są podstawą sukcesu w biznesie. Dlatego, w ramach partnerskiej współpracy oferujemy projektantom i architektom, którzy pracują z naszymi produktami, możliwość bezpłatnego serwisu doradczego. Wyszkolona grupa projektowych specjalistów pomaga naszym klientom zapewnić bezproblemową realizację ich indywidualnych projektów. Serwis obejmuje doradztwo techniczne od początku realizacji, aż po zakończenie inwestycji, dobór odpowiednich materiałów i chemii budowlanej RAKO System na poszczególne obiekty, oraz zalecane środki czyszczące do końcowego sprzężania pobudowanego. Kontakt do działu projektowego znajduje się na www.rako.eu

QUALITY – product inspection in harmony with nature

Through systematic product inspections we ensure that every single shipped item meets the most stringent quality criteria. The high quality of RAKO products meets the requirements of the ISO 9001 international system of quality and services management. Properties of the ceramic tiles meet the requirements of the EN 14411:2016 standard. Certificates issued by renowned test institutes are evidence of the products' first class quality. These certificates can be downloaded from www.rako.eu

Part of the corporate strategy is making environment-friendly products which meet national as well as international standards using an environment-friendly management system. By issuing an ISO 14 025 environmental product declaration, the company has undertaken to meet the requirements on environmental protection. LASSELSBERGER, s.r.o. as part of its environmental protection policy engages in a continual research and invests in systems of water recycling, ecological waste disposal, improving the quality of air and reducing the concentration of gases released into the air with the ultimate goal being zero pollution. Respecting applicable regulations, we use selected raw materials in the production and wrap final products in recycled packaging.

SERVICE – openness for individual projects

High-quality products and professional services are connected vessels to business success. Within the framework of a partnership, planners and architects working with our products can take advantage of our free advisory service. The trained team of project specialists help our customers to ensure trouble-free implementation of their individual concepts. The provided services consist of technical advice, from beginning of implementation to end of a particular order, including the selection of appropriate materials and RAKO SYSTEM building chemistry, according to individual buildings, tile laying plans, and calculation of materials, including recommended professional cleaners for final cleaning of surfaces. Contacts to project team are available at www.rako.eu

RAKO HOME – all from one hand

RAKO HOME offers an extensive range of ceramic wall and floor tiles including decorative and functional accessories for complete wall and floor solutions of bathrooms and kitchens as well as other home interiors, but also for outdoor applications such as balconies, terraces and staircases. RAKO HOME offers an individual approach to the client and sources inspiration from contemporary trends but at the same time maintains a harmony between design sophistication and demanding requirements on quality. Our on-going improvements allow us to create excellent series in respect of design and modern fixing technology, satisfying technical requirements of architects and the taste of end users. The current RAKO series has been created due to the most advanced digital HD Print technology. Digital printing allows the transfer of any decor in high resolution to a smooth or embossed ceramic surface. It enables the creation of authentic random patterns, the highlighting of natural elements, patina, sectional views of stones, or common surface treatment of wooden floors. The series made by digital printing has the following catalogue logo: ☼.

Bathrooms – timelessness, style, luxury

The extensive collection of the bathroom programme optimally combines the timeless with the modern series of wall tiles in formats 20 x 40, 20 x 60, 30 x 60, 30 x 90 cm and floor tiles for distinctive “tailor-made” designs inspired by modern trends, nature and a luxurious atmosphere.

FLOORS – functionality, quality, design

Flooring program represents a wide range of vitrified glazed tiles, up to the sizes of 60 x 60 and 80 x 80 cm, 20 x 120 and 30 x 120 cm which excel, in high quality, functionality, flawless technical properties and easy maintenance as well as design.

PROFESSIONAL SOLUTION – system, guarantee, technology

The RAKO comprehensive range is complemented by special RAKO SYSTEM building chemical products (www.rakosystem.eu) for system applications concerning base preparation and fixing, grouting, cleaning and maintenance.

TRADITION – Czech brand

LASSELSBERGER, s.r.o. is the only producer of ceramic tiles, RAKO brand, in the Czech Republic, and, at the same time, belongs among the leading producers in Europe. The traditional Czech brand “RAKO” celebrates its 135th anniversary this year. During this lengthy time, a diverse variety of realisations have been created from ceramic tiles. Some of these form an integral part of Czech cultural heritage, for example, Hotel Imperial or Obecní dům (the Municipal House) in Prague, Villa Tugendhat in Brno, and many others architectural gems admired worldwide. RAKO ceramic tiles are cornerstones of the success of LASSELSBERGER, s.r.o., due to its complete range of products, innovative capabilities and flexibility in purchase order processing, including rapid response to extraordinary requests of customers.

bevezetés

TRADÍCIÓ – cseh márka

A LASSELSBERGER, s.r.o. társaság Csehországban a RAKO márkájú kerámiacsempék egyedüli gyártója, és egyúttal európai szinten is a legfontosabb gyártók közé tartozik. A hagyományos cseh RAKO márka már ebben az évben 135 éves történelemre tekinthet vissza, amely során a kerámiacsempékből alkotott kivitelezések változatos palettája került kialakításra. Ezek közül néhány a cseh kulturális örökség elválaszthatatlan részét képezik, mint például az Imperial Szálloda vagy a Községháza Prágában, a Tugendhat villa Brünnben és számos további építészeti ékkő, amelyet ma az egész világ csodál. A RAKO kerámiacsempék a LASSELSBERGER, s.r.o. társaság sikerének alapkövét jelentik a teljes körű választék kínálatának, az újító szellemnek és a rendelések intézése során tapasztal rugalmasságnak köszönhetően, beleértve a gyors reagálást is az ügyfelek rendkívüli igényeire.

RAKO HOME – mindent egy kézből

A RAKO HOME márka többek között fürdőszobák, konyhák és más belső terek, illetve kültéri balkonok, teraszok és lépcsők kialakítására szolgáló kerámia fal- és padlóburkolatokat, továbbá azok díszítő és funkciók kiegészítőinek széles választékát kínálja. A RAKO HOME számára fontos, hogy az ügyfeleknek egyedi megoldásokat nyújtson, és hogy míg ihletet az aktuális irányzatokból merít, megőrzi a kifinomult dizájn és az igényes minőségi elvárások közötti összhangot. Folyamatos tökéletesítésre törekvésünk lehetőséget ad számunkra a dizájn és modern burkolástechnológia vonatkozásában a legmodernebb termékcsaládok készítésére, melyek a tervezők műszaki elvárásainak és a végfelhasználók ízlésének egyaránt képesek megfelelni. A jelenlegi RAKO sorozatok a legmodernebb digitális HD Print technológiával készülnek. A digitális nyomtatás lehetővé teszi a sima és a relief felületű kerámiára akár milyen dekoráció felvitelét nagy felbontásban. Sikerül létrehozni hiteles természetes véletlenszerűségeket, tökéletlenségeket, patinás, vágott kő, vagy a fából készült padló felületek mintáit. A digitális nyomtatású sorozat a katalógusunkban ezzel a logóval van jelölve: 

FÜRDŐSZOBÁK – kortalanság, stílus, luxus

A fürdőszobai program gazdag kollekcója optimálisan kombinálja a kortalan és modern csempék és járólapok termékcsaládjait, főleg 20 x 40, 20 x 60, 30 x 60, 30 x 90 cm formátusokban az aktuális irányzatok, természet és luxus érzete által inspirált egyéni, személyre szabott megoldásokkal.

PADLÓ – funkcionalitás, minőség, dizájn

A padlóprogram a színterezett mázas 60 x 60 és 80 x 80 cm, 20 x 120 és 30 x 120 cm méretű padlócssempék változatos kínálatát rejti magába, mely a dizájnon kívül kiváló minőségével, funkcionalitásával, tökéletes műszaki tulajdonságaival és egyszerű karbantartásával tűnik ki.

PROFESSZIONÁLIS MEGOLDÁS – rendszer, garancia, technológia

A rendszer alkalmazásához a RAKO márka komplex kínálatát az alap elkészítésének és ragasztásának, fugázásának, tisztításának és karbantartásának területén RAKO SYSTEM (www.rakosystem.eu) márkajelű speciális építőipari vegyi anyagok egészítik ki.

MINŐSÉG – termékellenőrzés a természettel összhangban

Az termékek rendszeres ellenőrzésével biztosítjuk, hogy árukiadásakor minden egyes termék teljesítse a legszigorúbb minőségi követelményeket. A RAKO termékek kiváló minősége megfelel a nemzetközi ISO 9001 szabvány szerinti minőségirányítási rendszernek és szolgáltatásoknak. A kerámiaburkolatok tulajdonságai megfelelnek a EN 14411:2016 szabvány előírásainak. Az első osztályú minőséget neves ellenőrző intézetek tanúsítványai bizonyítják. A dokumentumok a www.rako.eu oldalról tölthetők le.

A hatályos nemzeti és nemzetközi szabványoknak egyaránt megfelelő környezetkímélő termékek gyártása és a környezettudatos irányításrendszer alkalmazása része a vállalati stratégiának. A környezetvédelmi elvárások teljesítésére a társaság a termékről az ISO 14 025 szabvány szerinti környezetvédelmi nyilatkozattal kötelezi magát. A LASSELSBERGER, s.r.o. társaság a környezetvédelem keretén belül folyamatos kutatásokat és beruházásokat végez a víz újrahasznosítására, a hulladékok környezetvédő megsemmisítésére, a levegő minőségének javítására, továbbá a légkörbe jutó gázok koncentrációjának csökkentésére. Célja a zéró szennyezés elérése. A hatályos jogszabályok figyelembevételével a gyártáshoz válogatott alapanyagokat használunk, valamint a termékeket újrahasznosítható csomagolásba csomagoljuk.

SZOLGÁLTATÁS – nyitottság az egyedi elképzelésekre

A vállalkozásban elért sikerekhez elengedhetetlenek a minőségi termékek és a szakszerű szolgáltatások. A partneri együttműködés keretén belül ezért a termékeinkkel dolgozó tervezők és építésszek számára felkínáljuk azt a lehetőséget, hogy ingyenes tanácsadói szolgáltatást vehetnek igénybe. A projektspecialisták felkészült csapata segít az ügyfeleinknek, hogy gondmentesen válóra válthassák saját egyéni elképzeléseiket. Az általunk nyújtott szolgáltatások közé tartozik a tanácsadás, amely a megvalósítás kezdeti fázisától egészen a befejezésig terjed, és magába foglalja a megfelelő anyagok és a RAKO SYSTEM építőipari vegyi anyagok kiválasztását az egyes objektumok, csempe-lerakó tervek és a szükséges anyagmennyiség kiszámításának alapján, beleértve a professzionális tisztítószer javaslatait is, amelyek a felületek záró tisztításához szükségesek. A projektcsapat elérhetőségét itt találhatják: www.rako.eu

ВВЕДЕНИЕ

КАЧЕСТВО – проверка изделий в гармонии с природой

Посредством испытаний мы обеспечиваем соответствие каждого изделия самым строгим требованиям. Высокое качество продукции RAKO соответствует системе управления качеством и услугами (международный стандарт ISO 9001). Свойства керамической облицовочной плитки соответствуют требованиям стандарта EN 14411:2016. Сертификаты известных организаций, осуществляющих испытания, подтверждают первоклассное качество продукции. Документы для скачивания находятся на сайте www.rako.eu

Частью фирменной стратегии является производство экологически щадящих изделий, соответствующих требованиям действующих национальных и международных стандартов, которое использует систему управления и бережно относится к окружающей среде. Предприятие своим экологическим заявлением в отношении продукции обязуется, согласно ISO 14 025, выполнять требования по отношению к окружающей среде. В рамках защиты окружающей среды LASSELSBERGER, s.r.o. постоянно проводит исследования и инвестирует средства в очистку воды, экологическую ликвидацию отходов, улучшение качества атмосферы и снижение концентрации газов, выбрасываемых в атмосферу, с целью достижения нулевого уровня загрязнения. С учетом действующих предписаний мы используем для производства определенное сырье, а конечную продукцию упаковываем в подлежащую переработке упаковку.

СЕРВИС – открытость индивидуальным проектам

Качественная продукция и компетентные услуги представляют собой сообщающиеся сосуды для успешного бизнеса. Поэтому в рамках партнерского сотрудничества мы предлагаем проектировщикам и архитекторам, работающим с нашей продукцией, возможность воспользоваться нашим бесплатным консультационным сервисом. Обученная группа проектных специалистов помогает нашим заказчикам обеспечить верную реализацию их индивидуальных концепций. В комплекс услуг входят технические консультации, предоставляемые с самого начала реализации вплоть до завершения заказа, включающие выбор подходящих материалов и строительной химии RAKO SYSTEM в зависимости от конкретного объекта, разработку планов укладки и расчет необходимого количества материала, а также предоставление рекомендаций по выбору профессиональных чистящих средств для финальной уборки поверхностей. Контактная информация о проектной группе приведена на сайте www.rako.eu

RAKO HOME – все в комплексе

Марка RAKO HOME предлагает богатый ассортимент керамической облицовочной плитки и штучных материалов для полов, включая декоративные и функциональные дополнения для комплексной отделки стен и полов ванной комнаты и кухни, а также других бытовых интерьеров, равно как и для балконов, террас и лестниц в экстерьере. RAKO HOME принимает во внимание индивидуальный подход к клиенту, черпает вдохновение в современных тенденциях, и наряду с этим, сохраняет гармонию между изысканностью дизайна и высокими требованиями к качеству. Наше постоянное стремление к совершенствованию позволяет создавать серии самого высокого класса с учетом дизайна и современной технологии облицовки, способные удовлетворить как технические требования архитекторов, так и вкус конечного потребителя. Современные серии RAKO производятся в соответствии с самой передовой цифровой технологии, HD PRINT. Цифровая печать позволяет перенести на гладкую и рельефную поверхности керамической плитки любые декоры в высоком разрешении. Благодаря этому удается создать виды подлинной природы, неповторимость дизайна рисунка, имитация несовершенства поверхностей, патину, разнообразную структуру камня или обработанные деревянные полы. Серия, произведенные с помощью цифровой печати, отмечены в каталоге логотипом (значком): 

ВАННЫЕ КОМНАТЫ – вне времени, стиль, элитность

Коллекция программы отделки интерьеров для ванных комнат оптимально сочетает классические и современные тенденции в облицовочной плитке размером 20 x 40, 20 x 60, 30 x 60, 30 x 90 см в сочетании с напольной плиткой, обеспечивая реализацию разнообразных индивидуальных проектов, вдохновленных современными тенденциями, природой и роскошной атмосферой эксклюзива.

ПОЛЫ – функциональность, качество, дизайн

Ассортимент напольной плитки представлен широкой шкалой высокоспециальной глазурованной плитки размером 60 x 60 и 80 x 80 см, 20 x 120 и 30 x 120 см, которые, помимо интересного дизайна, отличаются качеством, функциональностью, совершенными техническими свойствами и простотой ухода за ними.

ПРОФЕССИОНАЛЬНЫЕ РЕШЕНИЯ – система, гарантии, технологии

Комплексное предложение марки RAKO дополнено специальными строительными химическими изделиями марки RAKO SYSTEM (www.rakosystem.eu) для системного применения в области подготовки оснований и укладки плитки, расшивки швов, чистки и ухода за облицовкой.

ТРАДИЦИЯ – чешская марка

Компания LASSELSBERGER, s.r.o. является единственным производителем керамических облицовочных материалов марки RAKO в Чехии и одновременно относится к крупнейшим производителям в Европе. Традиционная чешская марка RAKO в этом году празднует 135 годовщину. На протяжении длительной истории компании возникла пестрая шкала объектов, в которых были применены керамические облицовочные материалы марки RAKO. Некоторые объекты стали неотъемлемой составляющей чешского культурного наследия, например, гостиница «Империал» или Муниципальный дом в Праге, вилла «Тугендгат» в Брно и многие другие жемчужины архитектуры, которыми ныне восторгается весь мир. Настенная и напольная керамическая плитка марки RAKO является основой успеха компании LASSELSBERGER, s.r.o., благодаря полному ассортименту, инновационным способностям компании и гибкости в обработке заказов, включающей быструю реакцию на пожелания заказчиков.

koupelny bathrooms

AIR	86-89	PORTO	98-99
BASE	32-37	RAKO 1883	114-115
BOA	38-41	REMIX	156-157
CASA	52-55	RUSH	62-67
CONCEPT	142-151	SAMBA	155
CONCEPT PLUS	132-141	SANDY	108-109
DELTA	154	SENSO	100-103
EASY	110-113	STELLA	159
EXTRA	12-21	SYSTEM	164-167
GARDA	26-31	TENDENCE	90-95
GROUND	72-73	TEXTILE	122-123
CHARME	82-85	TRINITY	96-97
LAZIO	124-125	TULIP	152
LUCIE	162	UNICOLOR	104-107
MAJOLIKA	74-81	UNISTONE	116-117
MANO	22-25	UNIVERSAL	160-161
MANUFACTURA	118-121	UP	42-51
MARMO	163	VANITY	130-131
NEO	158	WENGE	128-129
NEXT	56-61	ZEN	126-127
PATINA	153		
PIANO	68-71		

news

news

news

podlahy floors

news

ALBA	170-175	PIETRA DI MARE	320-321
BASE	196-199	RANDOM	204-209
BOARD	210-215	ROCK	248-259
BRICKSTONE	238-239	ROCK INDUSTRIAL	260-261
CEMENTO	230-235	SANDSTONE PLUS	284-289
CLASSIC	322	SANDY	240-241
CLAY	262-267	SIDNEY	297
COMO	302-305	SIENA	242-245
CONCEPT	316-317	SPIRIT	296
DECO	236-237	STONES	224-229
DEFILE	290-293	TRAVERTIN	318-319
ERA	306-309	TREND	216-223
EXTRA	184-195	UNISTONE	272-279
FARO	200-203	VIA	310-313
FASHION	280-283	SCHODOVÉ TVAROVKY / SPECIAL STEP TILES	323
FORM	298-301	SKLADBY / FORMAT COMBINATIONS	324-325
GEO	294-295	TECHNICKÉ INFORMACE /	
GOLEM	246-247	TECHNICAL INFORMATION	326
KAAMOS	176-183		
PEBBLES	314-315		
PIETRA	268-271		

news



koupelny
bathrooms





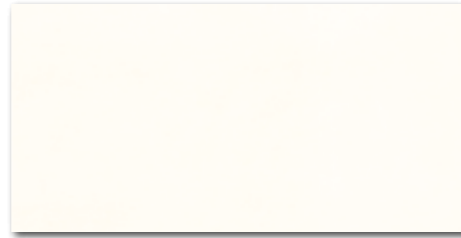

WADV4719
 ○ 80 / m²
 mat | matt

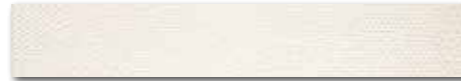

WLAS4719 60x9,5
 ○ 68 / ks
 mat | matt
 bילו-běžová / white-beige / biatobeżowa / бело-бежевый
 fehér-bézs / blanco-amarillento



DAR63722
 PEI 5 ○ 82 / m²
 mat | matt

bílá / white / biała / белый / fehér / blanco

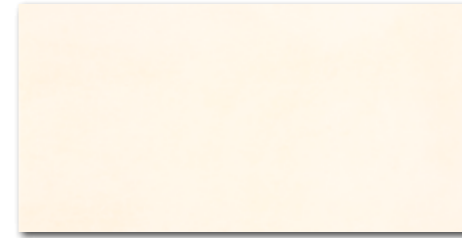

WADV4720
 ○ 80 / m²
 mat | matt



WARV4720
 ○ 84 / m²
 mat | matt
 slonová kost / ivory / kość słoniowa
 слонобая кость / elefántcsont / marfil



WLASN100
 ○ 60 / ks
 mat/lesk | matt/glossy
 měděná / cupreous / miedz
 медь / réz / cobre



DAR63720
 PEI 5 ○ 82 / m²
 mat | matt

slonová kost / ivory / kość słoniowa / слонобая кость / elefántcsont / marfil



WADV4721
 ○ 80 / m²
 mat | matt



DAR63721
 PEI 4 ○ 82 / m²
 mat | matt

hnědo-šedá / brown-grey / brązowoszara
 коричневый-серый szürke-barna / gris-marrón



30x60
 v2

60x2,3



60x60



R9



v2



výrobek / product



EN



ks/m²



m²



m²



kg



brutto kg

výrobek / product	cm	mm	EN	ks/m ²	m ²	m ²	kg	brutto kg			
obkládačka / wall tile	30x60	298x598x10	EN 14411:2016, annex L BIII GL	6	5,56	1,08	40	43,20	20,0	18,5	825
listela / listel	60x2,3	598x23x10	EN 14411:2016, annex L BIII GL	6	72,5	0,08	-	-	1,7	20,6	-
listela / listel	60x9,5	598x95x10	EN 14411:2016, annex L BIII GL	6	17,5	0,34	-	-	6,7	18,7	-
dlaždice / floor tile	60x60	598x598x10	EN 14411:2016, annex G BIIa GL	3	2,8	1,08	32	34,56	24,9	23,0	820

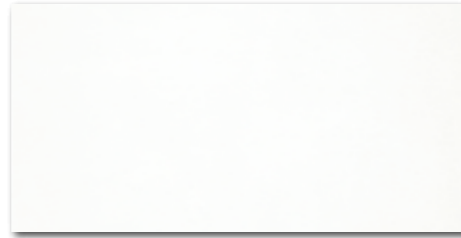

WADV4722
 ○ 80 / m²
 mat | matt

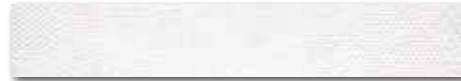

WLAS4722 60x9,5
 ○ 68 / ks
 mat | matt

bílo-šedá / white-grey / biato-szara
 бело-серый / fehér-szürke / blanco-gris

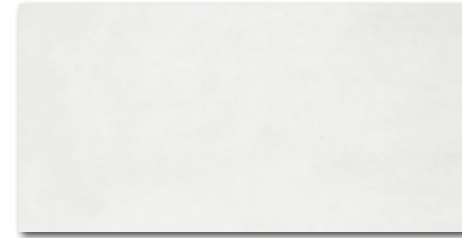

WADV4723
 ○ 80 / m²
 mat | matt



WARV4723
 ○ 84 / m²
 mat | matt
 světle šedá / light grey / jasnoszara / светло-серый
 világosszürke / gris claro



WLASN101
 ○ 60 / ks
 mat/lesk | matt/glossy
 platinová / platinum / platynowa
 платиновый / platina / platino



DAR63722
 PEI 5 ○ 82 / m²
 mat | matt

bílá / white / biata / белый / fehér / blanco



DAR63723
 PEI 4 ○ 82 / m²
 mat | matt

světle šedá / light grey / jasnoszara / светло-серый
 világosszürke / gris claro

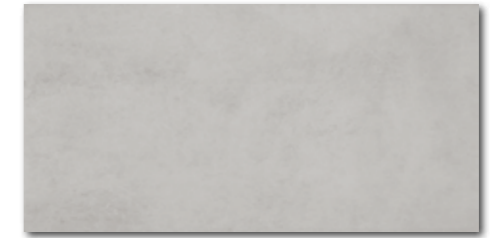

WADV4724
 ○ 80 / m²
 mat | matt



DAR63724
 PEI 4 ○ 82 / m²
 mat | matt

tmavě šedá / dark grey / ciemnoszara / темно-серый
 sötétszürke / gris oscuro



60x2,3



výrobek / product



EN



obkladacia / wall tile	30x60	298x598x10	EN 14411:2016, annex L BIII GL	6	5,56	1,08	40	43,20	20,0	18,5	825
listela / listel	60x2,3	598x23x10	EN 14411:2016, annex L BIII GL	6	72,5	0,08	-	-	1,7	20,6	-
listela / listel	60x9,5	598x95x10	EN 14411:2016, annex L BIII GL	6	17,5	0,34	-	-	6,7	18,7	-
dlaždice / floor tile	60x60	598x598x10	EN 14411:2016, annex G BIIa GL	3	2,8	1,08	32	34,56	24,9	23,0	820

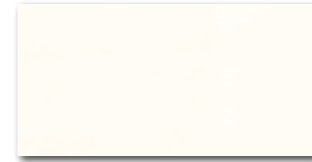

WADMB719
○ 72 / m²
mat | matt

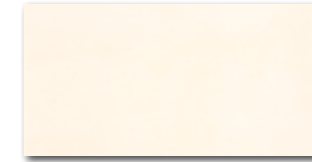

WADMB720
○ 72 / m²
mat | matt



WADMB721
○ 72 / m²
mat | matt

bílo-běžová / white-beige / białobezowa
бело-бежевый / fehér-bézs / blanco-amarillento



WADMB220*
○ 76 / m²
mat | matt | **V4**

slonová kost / ivory / kość stoniowa
слоновая кость / elefántcsont / marfil

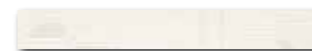

WLAMH719
○ 52 / ks
mat/lesk | matt/glossy

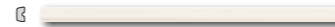

WLRMG719
○ 52 / ks
mat | matt



WLRMG720
○ 52 / ks
mat | matt



WLRMG721
○ 52 / ks
mat | matt



WDM05719 (SET)
○ 66 / set
mat | matt

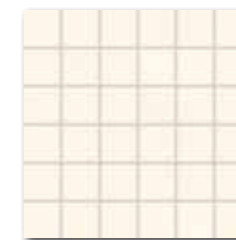

WDM05720 (SET)
○ 66 / set
mat | matt

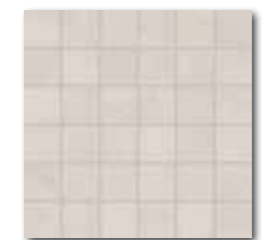

WDM05721 (SET)
○ 66 / set
mat | matt

bílo-běžová / white-beige / białobezowa
бело-бежевый / fehér-bézs / blanco-amarillento

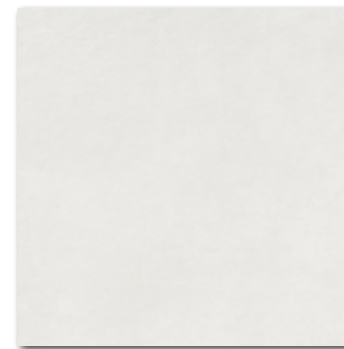

DAR44722
PEI 5 ○ 74 / m²
mat | matt



DAR44720
PEI 5 ○ 74 / m²
mat | matt



DAR44721
PEI 4 ○ 74 / m²
mat | matt

bílá / white / biata / белый / fehér / blanco

slonová kost / ivory / kość stoniowa
слоновая кость / elefántcsont / marfil

hnědo-šedá / brown-grey / brązowoszara
коричневый-серый / szürke-barna / gris-marrón

*Balení výrobku obsahuje nahodilý mix zobrazených designů. | The products are deliberately mixed in packing to include a random selection of designs.

40x4,8

40x2

30x30

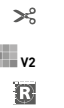

45x45



výrobek / product



EN



výrobek / product	20x40	40x4,8	40x2	30x30	45x45	EN	ks/m ²	m ²	m ³	kg/m ²	brutto kg
obkládačka / wall tile	20x40	198x398x7	198x398x7	198x398x7	198x398x7	EN 14411:2016, annex L BIII GL	20	12,5	1,60	48	76,80
listela / listel	40x4,8	398x48x7	398x48x7	398x48x7	398x48x7	EN 14411:2016, annex L BIII GL	7	52,1	0,13	-	1,8
reliefní listela / relief listel	40x2	398x20	398x20	398x20	398x20	STO No. 030 - 054498	12	125	0,09	-	1,7
mozaika set 30x30 cm / mosaic sheet 30x30 cm	5x5	48x48x7	48x48x7	48x48x7	48x48x7	STO No. 030 - 049913	3	11	0,27	-	3,5
dlaždice / floor tile	45x45	445x445x10	445x445x10	445x445x10	445x445x10	EN 14411:2016, annex G BIIa GL	6	5	1,21	26	31,46



výrobek / product	cm	mm	EN	ks/m ²	m ²	m ²	m ²	kg	kg/m ²	brutto kg
obkládačka / wall tile	20x40	198x398x7	EN 14411:2016, annex L BIII GL	20	12,5	1,60	48	76,80	20,6	12,9
listela / listel	40x4,8	398x48x7	EN 14411:2016, annex L BIII GL	7	52,1	0,13	-	-	1,8	13,6
reliéfní listela / relief listel	40x2	398x20	STO No. 030 - 054498	12	125	0,09	-	-	1,7	18,9
mozaika set 30x30 cm / mosaic sheet 30x30 cm	5x5	48x48x7	STO No. 030 - 049913	3	11	0,27	-	-	3,5	12,9
dlaždice / floor tile	45x45	445x445x10	EN 14411:2016, annex G BIIa GL	6	5	1,21	26	31,46	25,0	20,7



WADMB722
○ 72 / m²
mat | matt

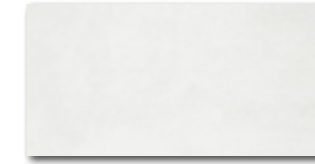

WADMB723
○ 72 / m²
mat | matt



WADMB724
○ 72 / m²
mat | matt

bílo-šedá / white-grey / biato-szara
бело-серый / fehér-szürke / blanco-gris



WADMB223*
○ 76 / m²
mat | matt | **V4**

světle šedá / light grey / jasnoszara / светло-серый
világosszürke / gris claro



WLAMH722
○ 52 / ks
mat/lesk | matt/glossy



WLRMG722
○ 52 / ks
mat | matt



WLRMG723
○ 52 / ks
mat | matt



WLRMG724
○ 52 / ks
mat | matt

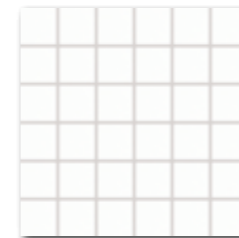

WDM05722 (SET)
○ 66 / set
mat | matt



WDM05723 (SET)
○ 66 / set
mat | matt



WDM05724 (SET)
○ 66 / set
mat | matt

bílo-šedá / white-grey / biato-szara
бело-серый / fehér-szürke / blanco-gris

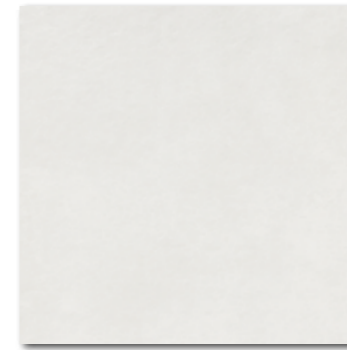

DAR44722
PEI 5 ○ 74 / m²
mat | matt

bílá / white / biata / белый / fehér / blanco



DAR44723
PEI 4 ○ 74 / m²
mat | matt

světle šedá / light grey / jasnoszara / светло-серый
világosszürke / gris claro



DAR44724
PEI 4 ○ 74 / m²
mat | matt

tmavě šedá / dark grey / ciemnoszara / темно-серый
sötétszürke / gris oscuro

*Balení výrobku obsahuje nahodilý mix zobrazených designů. | The products are deliberately mixed in packing to include a random selection of designs.



20x40
v2

40x4,8

40x2

30x30

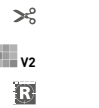

45x45





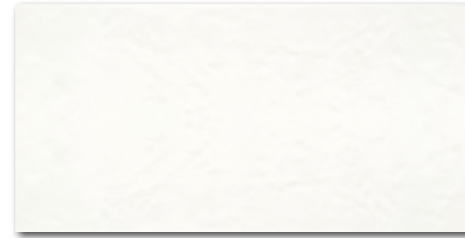

WARV4560
○ 80 / m²
mat | matt

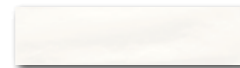

DARJ9560
○ 92 / m²
lesk | glossy

bílá / white / biata / белый / fehér / blanco



DAK63430
Base
PEI 5 ○ 86 / m²
mat | matt

slonová kost / ivory / kość słoniowa / слононая кость
elefántcsont / marfil světle béžová



DARSU715
Faro
PEI 5 ○ 84 / m²
mat | matt

běžovo-šedá / beige-grey / beżowo-szary
бежевый-серый / bézs-szürke / beige-gris



WARV4561
○ 80 / m²
mat | matt

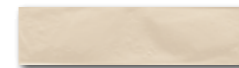

DARJ9561
○ 92 / m²
lesk | glossy

lesk | glossy



DAK63431
Base
PEI 5 ○ 86 / m²
mat | matt

světle béžová / light beige / jasno-beżowa
светло-бежевый / világosbézs / beige claro



DARSU718
Faro
PEI 4 ○ 84 / m²
mat | matt

hnědá / brown / brązowa / коричневый / barna / marrón



DARSU716
Faro
PEI 4 ○ 84 / m²
mat | matt

běžová / beige / beżowa / бежевый / bézs / beige

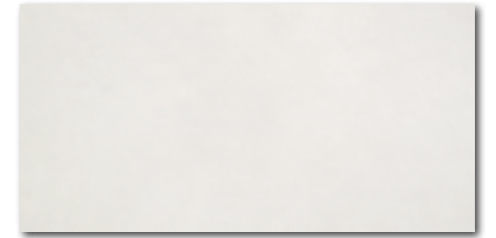

WARV4562
○ 80 / m²
mat | matt

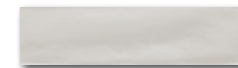

DARJ9562
○ 92 / m²
lesk | glossy

lesk | glossy



DAK63432
Base
PEI 5 ○ 86 / m²
mat | matt

světle šedá / light grey / jasnoszara
светло-серый / világosszürke / gris claro



DARSU719
Faro
PEI 5 ○ 84 / m²
mat | matt

šedo-bílá / grey-white / szaro-biata
серый и белый / szürke és fehér / blanco-gris



výrobek / product



EN



obkádacia / wall tile	30x60	298x598x10	EN 14411:2016, annex L BIII GL	6	5,56	1,08	40	43,20	20,0	18,5	825
inzeria / decór	30x7,5	298x75x10	EN 14411:2016, annex G BIIa GL	20	44,4	0,45	72	32,40	8,9	19,9	669
dlaždice / floor tile	60x60	598x598x10	EN 14411:2016, annex G BIIa GL	3	2,8	1,08	32	34,56	24,9	23,0	820
dlaždice / floor tile	15x60	148x598x10	EN 14411:2016, annex G BIIa GL	10	11,1	0,9	48	43,20	19,4	21,5	954





20x60

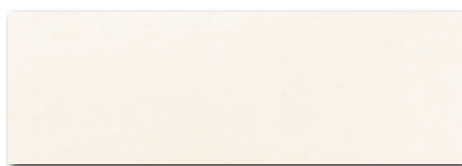

WADVE565
 ○ 76 / m²
 mat | matt | **V2**

světle béžová / light beige / jasnobežowa
 светло-бежевый / világosbézs / beige claro



WADVE566
 ○ 76 / m²
 mat | matt | **V2**

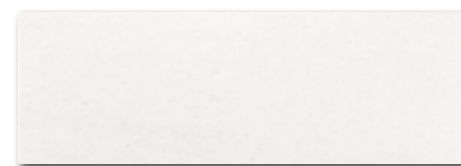

WADVE567
 ○ 76 / m²
 mat | matt | **V2**

světle šedá / light grey / jasnoszara / ветло-серый
 világosszürke / gris claro

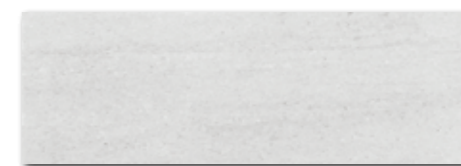

WADVE568
 ○ 76 / m²
 mat | matt | **V2**



WARVE566
 ○ 80 / m²
 mat | matt | **V3**



WARVE568
 ○ 80 / m²
 mat | matt | **V3**

60x2,3



WLRNS566
 ○ 70 / ks
 mat | matt



WLRNS568
 ○ 70 / ks
 mat | matt

60x9,5



WLAS4566
 ○ 68 / ks
 mat | matt



WLAS4568
 ○ 68 / ks
 mat | matt



33x33



R9

A

V2



DAA3B569
 PEI 4 ○ 68 / m²
 mat | matt

hnědo-šedá / brown-grey / brązowoszara
 коричневый-серый / szürke-barna / gris-marrón



DAA3B566
 PEI 5 ○ 68 / m²
 mat | matt

béžová / beige / bežowa
 бежевый / bézs / beige

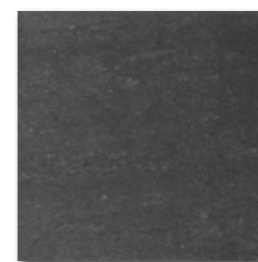

DAA3B570
 PEI 3 ○ 68 / m²
 mat | matt

tmavě šedá / dark grey / ciemnoszara / темно-серый
 sötétiszürke / gris oscuro



DAA3B568
 PEI 5 ○ 68 / m²
 mat | matt

šedá / grey / szara / серый
 szürke / gris



20x60



33x33



R9

A

V2

výrobek / product



EN



brutto kg

výrobek / product	cm	mm	EN	Box	ks/m ²	m ²	Box	Box	kg	kg/m ²	brutto kg
obkladacia / wall tile	20x60	198x598x10	EN 14411:2016, annex L BIII GL	9	8,3	1,08	42	45,36	20,0	18,5	865
reliefní listela / relief listel	60x2,3	598x23	STO No. 030 - 054498	6	72,5	0,08	-	-	1,4	17,5	-
listela / listel	60x9,5	598x95x10	EN 14411:2016, annex L BIII GL	6	17,5	0,34	-	-	6,7	18,7	-
dlaždice / floor tile	33x33	333x333x8	EN 14411:2016, annex G BIIa GL	12	9	1,33	44	58,52	23,6	17,7	1 061



20x40

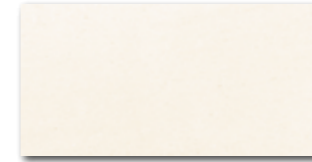

WADMB565
 ○ 68 / m²
 mat | matt | **V2**
 světle béžová / light beige / jasnobežowa
 светло-бежевый / világosbézs / beige claro



WADMB566
 ○ 68 / m²
 mat | matt | **V2**



WADMB569
 ○ 78 / m²
 mat | matt | **V3**



WADMB570
 ○ 74 / m²
 mat | matt | **V3**



WLAMI566
 ○ 58 / ks
 mat | matt



WLRMG566
 ○ 58 / ks
 mat | matt



GLLJV100
 ○ 40 / ks
 lesk | glossy
 béžová / beige / bežowa
 бежевый / bézs / beige

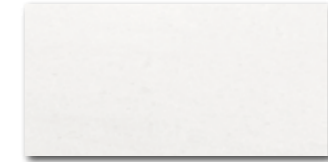

WADMB567
 ○ 68 / m²
 mat | matt | **V2**
 světle šedá / light grey / jasnoszara / ветло-серый
 világosszürke / gris claro

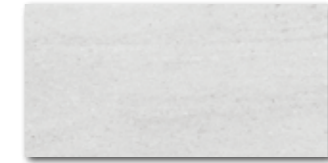

WADMB568
 ○ 68 / m²
 mat | matt | **V2**



WADMB571
 ○ 78 / m²
 mat | matt | **V3**

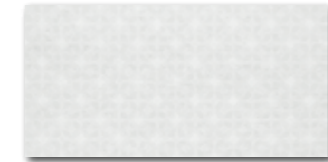

WADMB572
 ○ 74 / m²
 mat | matt | **V3**

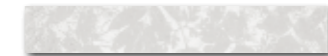

WLAMI568
 ○ 58 / ks
 mat | matt



WLRMG568
 ○ 58 / ks
 mat | matt
 šedá / grey / szara / серый
 szürke / gris



GLLJV101
 ○ 40 / ks
 lesk | glossy
 bílo-šedá / white-grey / biato-szara
 бело-серый / fehér-szürke / blanco-gris

40x6

40x2,3

30x2,5

výrobek / product



obkladka / wall tile	20x40	198x398x7	EN 14411:2016, annex L BIII GL	20	12,5	1,60	48	76,80	20,6	12,9	1 016
listela / listel	40x6	398x60x7	EN 14411:2016, annex L BIII GL	6	41,7	0,14	-	-	1,9	13,6	-
reliefní listela / relief listel	40x2,3	398x23	STO No. 030 - 054498	12	108,7	0,11	-	-	1,8	16,4	-
listela / listel	30x2,5	300x25x7	EN 1469:2015	20	133,3	0,15	-	-	2,4	16,0	-



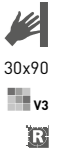
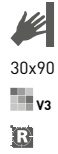

WARV5430
○ 88 / m²
mat | matt



WARV5431
○ 88 / m²
mat | matt



WR1V5430
○ 92 / m²
mat | matt

slonová kost / ivory / kość słoniowa / слоно́вая ко́сть / elefántcsont / marfil

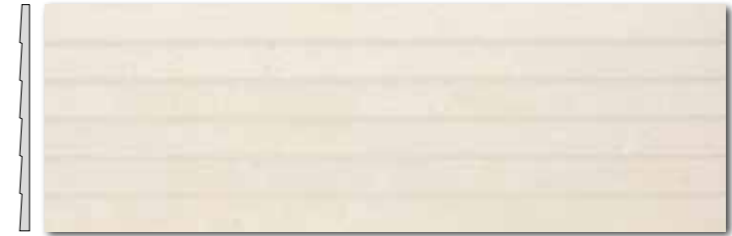

WR1V5431
○ 92 / m²
mat | matt

světle béžová / light beige / jasnobeżowa
светло-бежевый / világosbézs / beige claro



WR1V5435
○ 92 / m²
mat | matt

světle béžová / light beige / jasnobeżowa
светло-бежевый / világosbézs / beige claro



WR1V5434
○ 92 / m²
mat | matt

hnědá / brown / brązowa / коричневый / barna / marrón



DAK63430
PEI 5 ○ 86 / m²
mat | matt

slonová kost / ivory / kość słoniowa / слоно́вая ко́сть
elefántcsont / marfil světle béžová



DAK63431
PEI 5 ○ 86 / m²
mat | matt

světle béžová / light beige / jasnobeżowa
светло-бежевый / világosbézs / beige claro

výrobek / product



obkládačka / wall tile
dlaždice / floor tile

30x90

298x898x10,5

EN 14411:2016, annex L BIII GL

4

3,7

1,08

30

32,40

21,7

20,1

677

60x60

598x598x10

EN 14411:2016, annex G BIIa GL

3

2,8

1,08

32

34,56

24,9

23,0

820

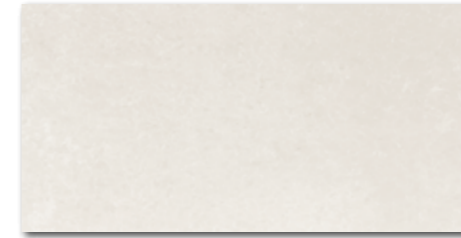

WARV4430
82 / m²
mat | matt



WARV4431
82 / m²
mat | matt



WR1V4430
86 / m²
mat | matt

slonová kost / ivory / kość słoniowa / слоновая кость
elefántcsont / marfil

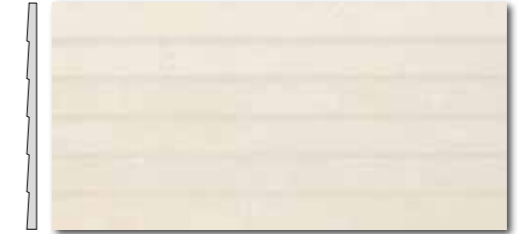

WR1V4431
86 / m²
mat | matt

světle béžová / light beige / jasnobežowa
светло-бежевый / világosbézs / beige claro



WR1V4435
86 / m²
mat | matt

světle béžová / light beige / jasnobežowa
светло-бежевый / világosbézs / beige claro



WR1V4434
86 / m²
mat | matt

hnědá / brown / brązowa / коричневый / barna / marrón

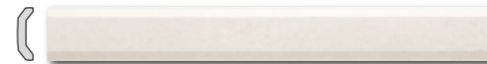

WLRSP430
86 / ks
mat | matt



WLRSP431
86 / ks
mat | matt

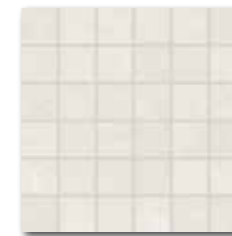

WDM06430 (SET)
66 / set
mat | matt

slonová kost / ivory / kość słoniowa / слоновая кость
elefántcsont / marfil

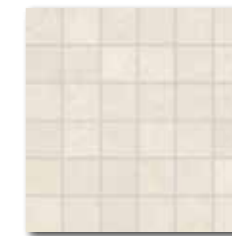

WDM06431 (SET)
66 / set
mat | matt

světle béžová / light beige / jasnobežowa
светло-бежевый / világosbézs / beige claro



DARSU716
Faro
PEI 4 84 / m²
mat | matt

běžová / beige / beżowa / бежевый / bézs / beige



DARSU718
Faro
PEI 4 84 / m²
mat | matt

hnědá / brown / brązowa / коричневый / barna / marrón

výrobek / product	cm	mm	EN	ks/m ²	m ²	m ³	kg/m ²	brutto kg			
obkladáčka / wall tile	30x60	298x598x10	EN 14411:2016, annex L BIII GL	6	5,56	1,08	40	43,20	20,0	18,5	825
reliefní listela / relief listel	60x7	598x70x10	STO č. 030 - 054498	4	23,8	0,17	-	-	3,4	20,1	-
mozaika set 30x30 cm / mosaic sheet 30x30 cm	5x5	48x48x10	STO č. 030 - 049913	3	11	0,27	-	-	5,0	18,5	-
dlaždice / floor tile	15x60	148x598x10	EN 14411:2016, annex G BIIa GL	10	11,1	0,9	48	43,20	19,4	21,5	954







Všechny výrobky celé série vykazují velké odchylky odstínové difference V3. / All products of the entire batch show big deviations in shade difference V3.

Před pokládkou doporučujeme jednotlivé obkládací prvky vybrat z několika kartonů a výslednou plochu komponovat podle inspirativní fotodokumentace z katalogů RAKO případně z webových stránek www.rako.cz

Žádoucí je kombinace všech jednotlivých designů obkládacích prvků včetně jejich natáčení o 180°, aby se dosáhlo optimálního vyváženého vzhledu podlahy nebo stěny.

Before laying the tiles, we suggest you select from several cartons and arrange them as illustrated in the inspiration photo documentation in RAKO catalogues or website www.rako.eu, and mix the tiles to achieve the required result including turning them by 180°.

Przed wyklejeniem zaleca się wyciągnąć płytki z kilku kartonów i rozłożyć na jednej powierzchni. Przy układaniu można się inspirować zdjęciami w katalogu lub na stronach internetowych www.rako.eu

Wskazane jest przekładanie poszczególnych płytek, włącznie z ich obracaniem o 180° aż do osiągnięcia optymalnego wyglądu ściany, czy podłogi.

A burkolólápok ragasztása előtt javasoljuk, hogy több dobozról vegye ki a burkolólápokokat és rakja ki a végleges mintázatot. A mintázatot létrehozásához használhatja a RAKO katalógus inspiratív fényképeit vagy a www.rako.eu weblapon található képeket.

Kombinálja az egyes burkolólápol elemeket igény szerint, illetve azokat 180°-kal is elforgathatja az optimális és harmónikus fal vagy padlóminták kialakításához.

Перед укладкой рекомендуется вынуть отдельные элементы плитки из нескольких картонных коробок и составить желаемый рисунок, исходя из разных примеров, указанных на фото в каталогах RAKO или на сайте www.rako.eu

Для достижения оптимального гармоничного вида облицовки стен или плиточного покрытия пола желательно комбинировать отдельные элементы, поворачивая их на 180°.

Antes de la colocación siempre recomendamos desembalar varias cajas y probar a colocar el material en la composición elegida en los catálogos de RAKO en las páginas de internet web www.rako.eu

Se recomienda la colocación de todos los posibles elementos de la decoración incluso girar los individualmente entre 180°, para conseguir la composición deseada y equilibrada del pavimento o revestimiento.



WAKV4525
84 / m²
mat | matt

bílá / white / biata / белый / fehér / blanco



WAKV5525
90 / m²
mat | matt



WAKV4526
84 / m²
mat | matt

světle šedá / light grey / jasnoszara / светло-серый / világosszürke / gris claro



WAKV5526
90 / m²
mat | matt

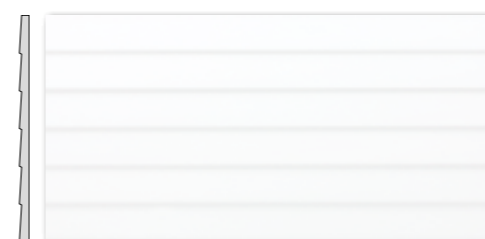

WR1V4000
86 / m²
lesk | glossy

WR1V4104
86 / m²
mat | matt

WR1V5000
92 / m²
lesk | glossy

WR1V5104
92 / m²
mat | matt



WDM02525 (SET)
78 / set
mat | matt



WDM06525 (SET)
66 / set
mat | matt



WDM02526 (SET)
78 / set
mat | matt



WDM06526 (SET)
66 / set
mat | matt

bílá / white / biata / белый / fehér / blanco



DARSU718
Faro
PEI 4 84 / m²
mat | matt | **V4**

hnědá / brown / brązowa / коричневый / barna / marrón



DAK63653
Trend
PEI 5 82 / m²
mat | matt | **V2**

světle šedá / light grey / jasnoszara / светло-серый / világosszürke / gris claro



30x60
30x90



30x60
30x90



30x30



15x60
60x60



výrobek / product	cm	mm	EN	ks/m ²	m ²	kg	brutto kg				
obkládacíka / wall tile	30x60	298x598x10	EN 14411:2016, annex L BIII GL	6	5,56	1,08	40	43,20	20,0	18,5	825
obkládacíka / wall tile	30x90	298x898x10,5	EN 14411:2016, annex L BIII GL	4	3,7	1,08	30	32,40	21,7	20,1	677
mozaika set 30x30 cm / mosaic sheet 30x30 cm	2,5x2,5	23x23x10	STO č. 030 - 049913	3	11	0,27	-	-	5,0	18,5	-
mozaika set 30x30 cm / mosaic sheet 30x30 cm	5x5	48x48x10	STO č. 030 - 049913	3	11	0,27	-	-	5,0	18,5	-
dlaždice / floor tile	15x60	148x598x10	EN 14411:2016, annex G BIIa GL	10	11,1	0,9	48	43,20	19,4	21,5	954
dlaždice / floor tile	60x60	598x598x10	EN 14411:2016, annex G BIIa GL	3	2,8	1,08	32	34,56	24,9	23,0	820

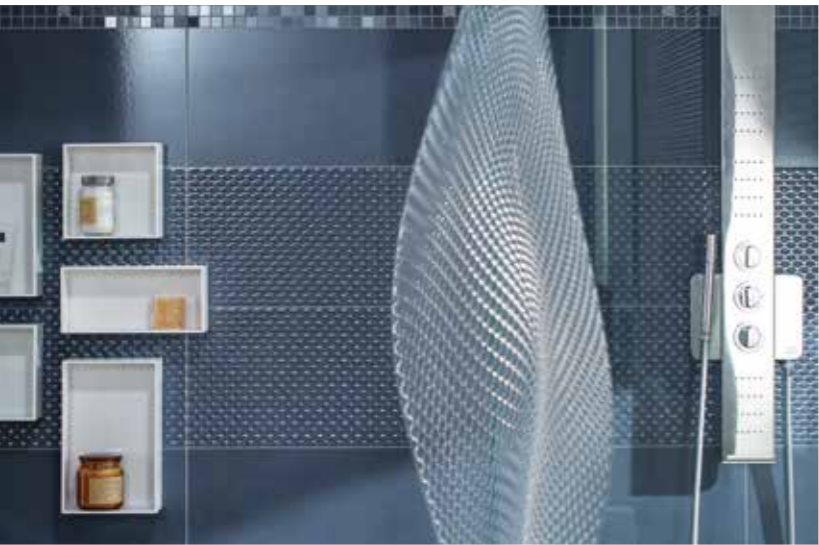

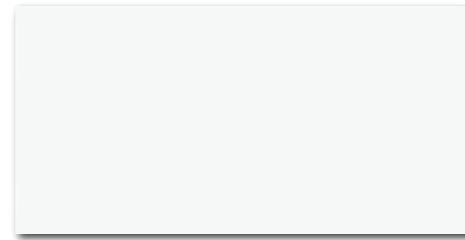

WAKV4000
○ 84 / m²
lesk | glossy | **V1**

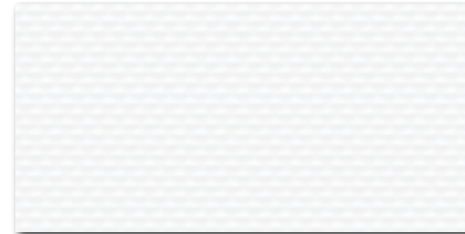

WR3V4000*
○ 86 / m²
lesk | glossy | **V2**

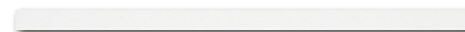

WLASN000
○ 66 / ks
lesk | glossy

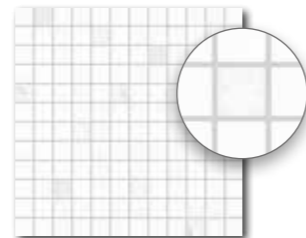

WDM02000 (SET)
○ 78 / set
lesk | glossy
bílá / white / biata / белый / fehér / blanco

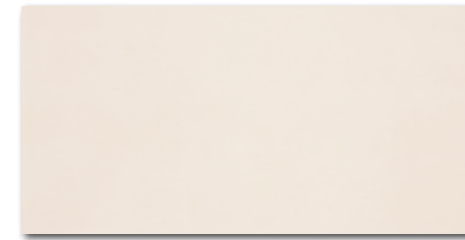

WAKV4508
○ 84 / m²
lesk | glossy | **V2** |

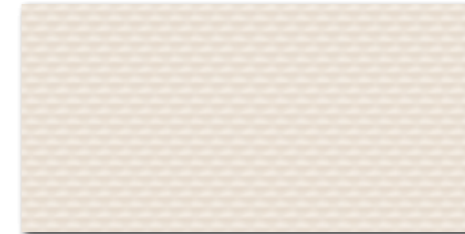

WR3V4508*
○ 86 / m²
lesk | glossy | **V2** |

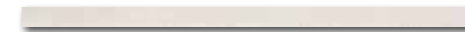

WLASN508
○ 66 / ks
lesk | glossy

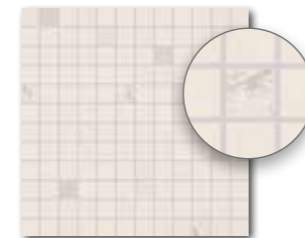

WDM02508 (SET)
○ 78 / set
lesk | glossy
světlé béžová / light beige / jasno-beżowa
светло-бежевый / világosbézs / beige claro

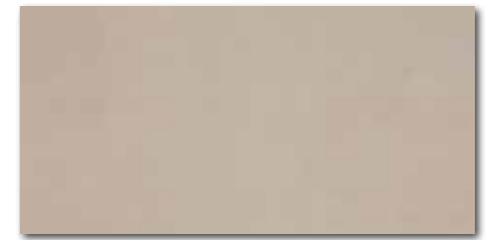

WAKV4509
○ 84 / m²
lesk | glossy | **V2** |

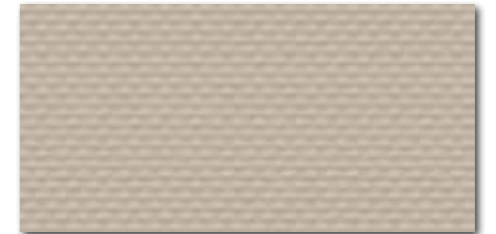

WR3V4509*
○ 86 / m²
lesk | glossy | **V2** |



WLASN509
○ 66 / ks
lesk | glossy

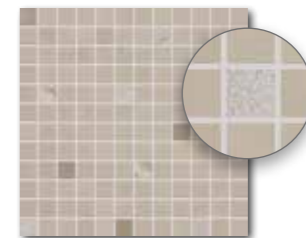

WDM02509 (SET)
○ 78 / set
lesk | glossy
šedohnědá / šedohnědá / grey-brown / szarobrazowa
серо-коричневый / barna-szürke / gris-marrón



DAR81720
Extra
PEI 5 ○ 94 / m²
mat | matt
slonová kost / ivory / kość słoniowa / слоновая кость / elefántcsont / marfil

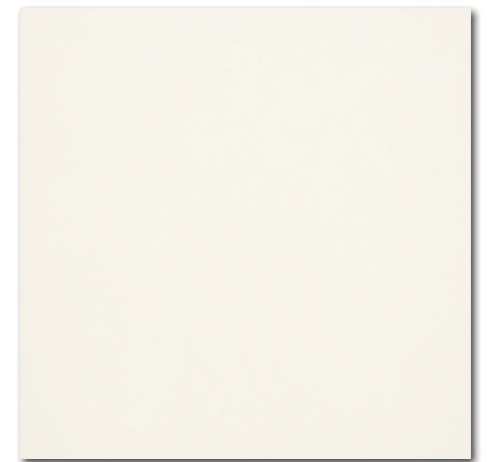

DAK63652
Trend
PEI 5 ○ 82 / m²
mat | matt



30x60

60x2,3

30x30

V3



80x80
60x60

R9

A

V2

R

výrobek / product	cm	mm	EN	ks/m ²	m ²	m ³	kg	kg/m ²	brutto kg		
obkládky / wall tile	30x60	298x598x10	EN 14411:2016, annex L BIII GL	6	5,56	1,08	40	43,20	20,0	18,5	825
listy / list	60x2,3	598x23x10	EN 14411:2016, annex L BIII GL	6	72,5	0,08	-	-	1,5	18,5	-
mozaika set 30x30 cm / mosaic sheet 30x30 cm	2,5x2,5	23x23x10	STO č. 030 - 049913	3	11	0,27	-	-	5,0	18,5	-
dlaždice / floor tile	80x80	798x798x10	EN 14411:2016, annex G BIIa GL	2	1,6	1,28	40	51,20	28,0	21,9	1 147
dlaždice / floor tile	60x60	598x598x10	EN 14411:2016, annex G BIIa GL	3	2,8	1,08	32	34,56	24,9	23,0	820

*Pro dosažení optimálního efektu doporučujeme pokládku jednotlivých obkládků jedním směrem. / For optimal effect, the laying of individual tiles in one direction is recommended.

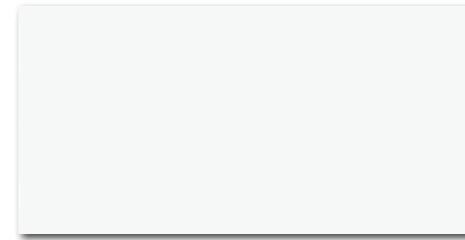

WAKV4000
○ 84 / m²
lesk | glossy | **V1**

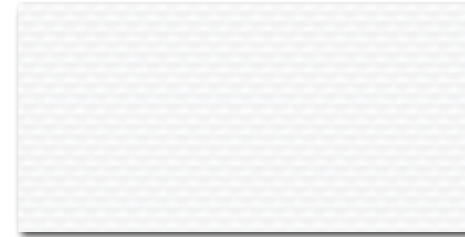

WR3V4000*
○ 86 / m²
lesk | glossy | **V2**

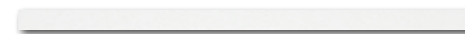

WLASN000
○ 66 / ks
lesk | glossy

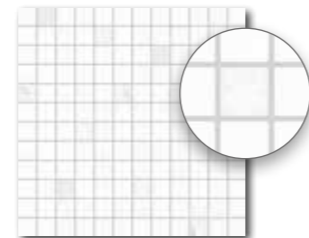

WDM02000 (SET)
○ 78 / set
lesk | glossy

bilá / white / biata / белый / fehér / blanco

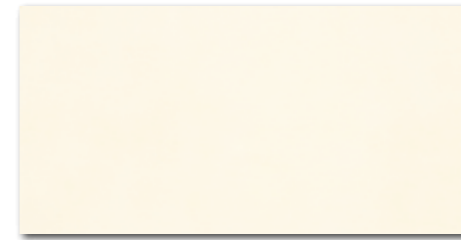

WAKV4510
○ 84 / m²
lesk | glossy | **V2** | ✨

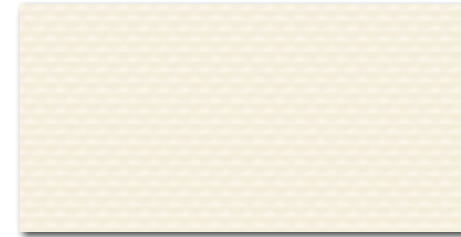

WR3V4510*
○ 86 / m²
lesk | glossy | **V2** | ✨

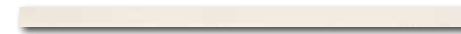

WLASN510
○ 66 / ks
lesk | glossy

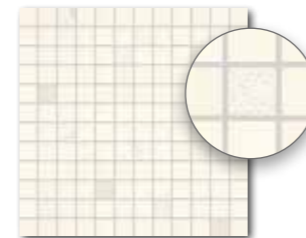

WDM02510 (SET)
○ 78 / set
lesk | glossy

slonová kost / ivory / kość słoniowa
слоновая кость / elefántcsont / marfil

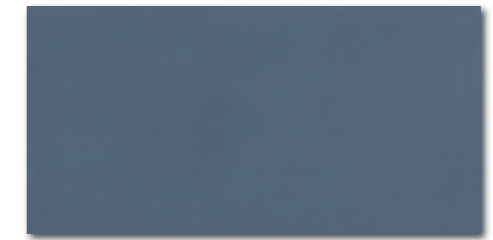

WAKV4511
○ 84 / m²
lesk | glossy | **V2** | ✨

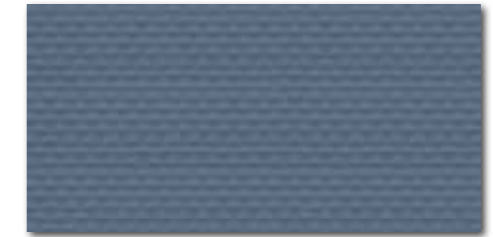

WR3V4511*
○ 86 / m²
lesk | glossy | **V2** | ✨



WLASN511
○ 66 / ks
lesk | glossy

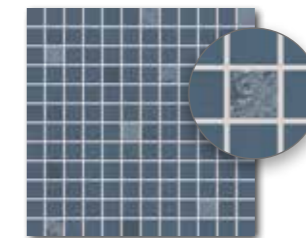

WDM02511 (SET)
○ 78 / set
lesk | glossy

tmavě modrá / dark blue / ciemnoniebieski
темно-синий / sötétkék / azul oscuro



DAKVF142
Board
PEI 4 ○ 98 / m²
mat | matt

běžová / beige / bežova / бежевый / bézs / beige



výrobek / product	cm	mm	EN	ks/m ²	m ²	kg	brutto kg				
obkládačka / wall tile	30x60	298x598x10	EN 14411:2016, annex L BIII GL	6	5,56	1,08	40	43,20	20,0	18,5	825
listela / listel	60x2,3	598x23x10	EN 14411:2016, annex L BIII GL	6	72,5	0,08	-	-	1,5	18,5	-
mozaika set 30x30 cm / mosaic sheet 30x30 cm	2,5x2,5	23x23x10	STO č. 030 - 049913	3	11	0,27	-	-	5,0	18,5	-
dlaždice / floor tile	30x120	298x1198x10	EN 14411:2016, annex G BIIa GL	3	2,8	1,08	28	30,24	24,0	22,2	697

* Pro dosažení optimálního efektu doporučujeme pokládku jednotlivých obkládů jedním směrem. / For optimal effect, the laying of individual tiles in one direction is recommended.



20x40

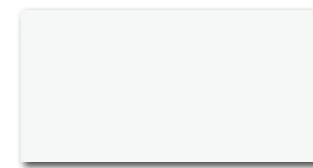

WAAMB000
○ 72 / m²
lesk | glossy | **V1**

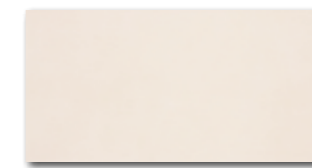

WADMB508
○ 74 / m²
lesk | glossy | **V2** | ❄️

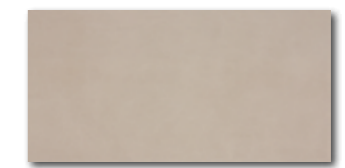

WADMB509
○ 74 / m²
lesk | glossy | **V2** | ❄️



WADMB513
○ 78 / m²
lesk | glossy | **V4** | ❄️

vícibarevná / multicoloured / kolorowa
многочетный / többszínű / multicolor



WITMB000
○ 64 / ks
mat/lesk | matt/glossy



WITMB508
○ 64 / ks
mat/lesk | matt/glossy



WITMB509
○ 64 / ks
mat/lesk | matt/glossy



WLAMH000
○ 50 / ks
mat/lesk | matt/glossy



WLAMH508
○ 50 / ks
mat/lesk | matt/glossy



WLAMH509
○ 50 / ks
mat/lesk | matt/glossy



WLRMG000
○ 52 / ks
lesk | glossy



WLRMG508
○ 52 / ks
lesk | glossy



WLRMG509
○ 52 / ks
lesk | glossy

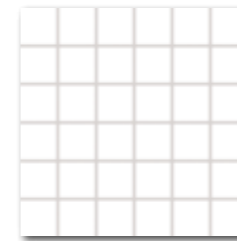

WDM05000 (SET)
○ 66 / set
lesk | glossy | **V1**



WDM05508 (SET)
○ 66 / set
lesk | glossy | **V2** | ❄️

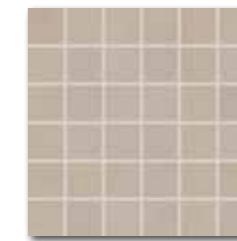

WDM05509 (SET)
○ 66 / set
lesk | glossy | **V2** | ❄️

světle béžová / light beige / jasnobežová
светло-бежевый / világosbézs / beige claro

šedohnědá / šedohnědá / grey-brown / szarobrazowa
серо-коричневый / barna-szürke / gris-marrón



DAK44182
Spirit
PEI 5 ○ 82 / m²
mat/lesk | matt/glossy | **R9**
bílá / white / biata / белый / fehér / blanco



DAK44657
Trend
PEI 4 ○ 74 / m²
mat | matt | **R9** | **A** | ❄️
hnědo-šedá / brown-grey / brązowoszara
коричневый-серый / szürke-barna / gris-marrón

40x4,5

40x2

30x30



45x45



výrobek / product



EN



ks/m²

m²



m²



kg

kg/m²



brutto kg

výrobek / product	cm	mm	EN	ks/m ²	m ²	m ²	kg	kg/m ²	brutto kg		
obkládačka / wall tile	20x40	198x398x7	EN 14411:2016, annex L BIII GL	20	12,5	1,60	48	76,80	20,6	12,9	1 016
inzerťo / insert (WITMB...)	20x40	198x398x7	EN 14411:2016, annex L BIII GL	8	12,5	0,64	-	-	8,3	12,9	-
listela / listel	40x4,5	398x45x7	EN 14411:2016, annex L BIII GL	10	55,6	0,18	-	-	2,3	12,9	-
reliefní listela / relief listel	40x2	398x20	STO č. 030 - 054498	12	125	0,10	-	-	1,8	18,8	-
mozaika set 30x30 cm / mosaic sheet 30x30 cm	5x5	48x48x7	STO č. 030 - 049913	3	11	0,27	-	-	3,5	12,9	-
dlaždice / floor tile	45x45	445x445x10	EN 14411:2016, annex G BIIa GL	6	5	1,21	26	31,46	25,0	20,7	677

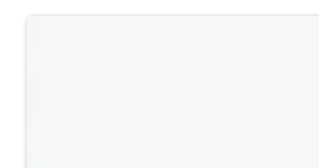

WAAMB000
○ 72 / m²
lesk | glossy | **V1**

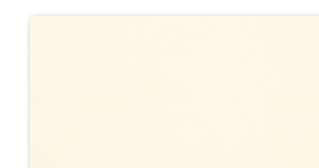

WADMB510
○ 74 / m²
lesk | glossy | **V2** |



WADMB511
○ 74 / m²
lesk | glossy | **V2** |



WADMB512*
○ 78 / m²
lesk | glossy | **V4** |



vícebarevná / multicoloured / kolorowa / многоцветный / többszínű / multicolor



WITMB000
○ 64 / ks
mat/lesk | matt/glossy



WITMB510
○ 64 / ks
mat/lesk | matt/glossy



WITMB511
○ 64 / ks
mat/lesk | matt/glossy



WLAMH000
○ 50 / ks
mat/lesk | matt/glossy



WLAMH510
○ 50 / ks
mat/lesk | matt/glossy



WLAMH511
○ 50 / ks
mat/lesk | matt/glossy

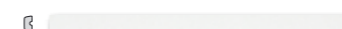

WLRMG000
○ 52 / ks
lesk | glossy

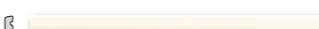

WLRMG510
○ 52 / ks
lesk | glossy



WLRMG511
○ 52 / ks
lesk | glossy

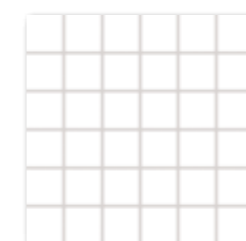

WDM05000 (SET)
○ 66 / set
lesk | glossy | **V1**

bílá / white / biata / белый / fehér / blanco

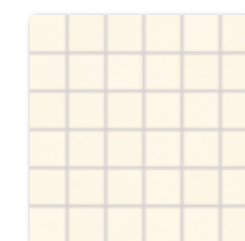

WDM05510 (SET)
○ 66 / set
lesk | glossy | **V2** |

slonová kost / ivory / kość stoniowa / слонобая кость / elefántcsont / marfil

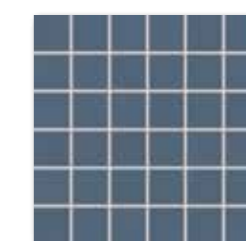

WDM05511 (SET)
○ 66 / set
lesk | glossy | **V2** |

tmavě modrá / dark blue / ciemnoniebieski / темно-синий / sötétkék / azul oscuro



DARSU719
Faro
PEI 5 ○ 84 / m²
mat | matt
šedo-bílá / grey-white / szaro-biata / серый и белый / szürke és fehér / blanco-gris



DARSU716
Faro
PEI 4 ○ 84 / m²
mat | matt
běžová / beige / beżowa / бежевый / bézs / beige

výrobek / product	cm	mm	EN	ks/m ²	m ²	m ²	m ²	kg	kg/m ²	brutto kg	
obkládačka / wall tile	20x40	198x398x7	EN 14411:2016, annex L BIII GL	20	12,5	1,60	48	76,80	20,6	12,9	1 016
inzerťo / insert (WITMB...)	20x40	198x398x7	EN 14411:2016, annex L BIII GL	8	12,5	0,64	-	-	8,3	12,9	-
listela / listel	40x4,5	398x45x7	EN 14411:2016, annex L BIII GL	10	55,6	0,18	-	-	2,3	12,9	-
reliefní listela / relief listel	40x2	398x20	STO č. 030 - 054498	12	125	0,10	-	-	1,8	18,8	-
mozaika set 30x30 cm / mosaic sheet 30x30 cm	5x5	48x48x7	STO č. 030 - 049913	3	11	0,27	-	-	3,5	12,9	-
dlaždice / floor tile	15x60	148x598x10	EN 14411:2016, annex G BIIa GL	10	11,1	0,9	48	43,20	19,4	21,5	954



20x40

40x4,5

40x2

30x30



30x30



30x30



30x30



30x30



30x30



30x30



30x30



30x30



30x30



30x30



30x30



30x30



30x30



30x30



30x30



30x30

*Balení výrobku obsahuje nahodilý mix zobrazených designů. | The products are deliberately mixed in packing to include a random selection of designs.



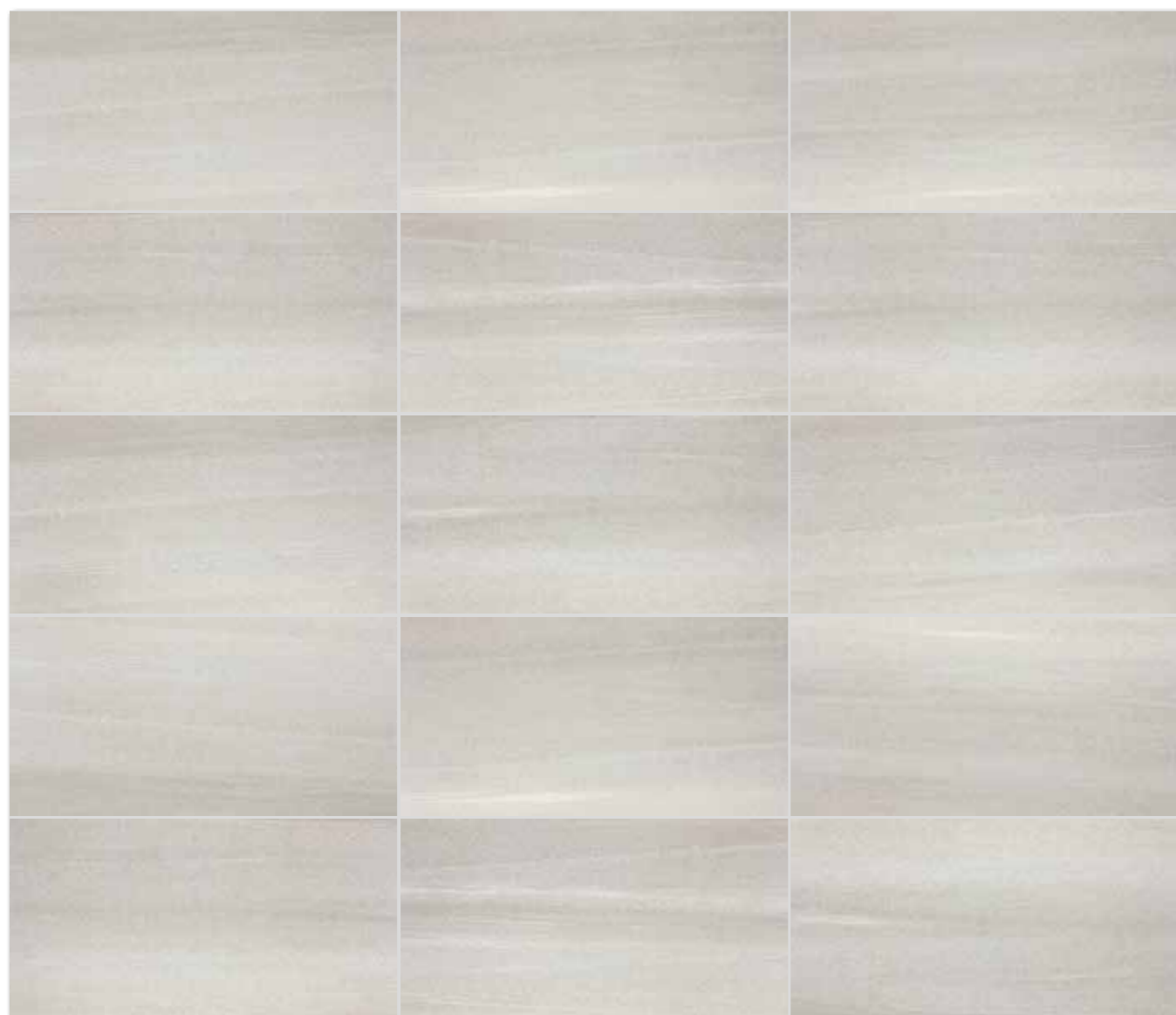

Všechny výrobky celé série vykazují velké odchylky odstínové difference V3. / All products of the entire batch show big deviations in shade difference V3.

Před pokládkou doporučujeme jednotlivé obkladové prvky vybírat z několika kartonů a výslednou plochu komponovat podle inspirační fotodokumentace z katalogů RAKO případně z webových stránek www.rako.cz

Žádoucí je kombinace všech jednotlivých designů obkladových prvků včetně jejich natáčení o 180°, aby se dosáhlo optimálního vyváženého vzhledu podlahy nebo stěny.

Before laying the tiles, we suggest you select from several cartons and arrange them as illustrated in the inspiration photo documentation in RAKO catalogues or website www.rako.eu, and mix the tiles to achieve the required result including turning them by 180°.

Przed wyklejeniem zaleca się wyciągnąć płytki z kilku kartonów i rozłożyć na jednej powierzchni. Przy układaniu można się inspirować zdjęciami w katalogu lub na stronach internetowych www.rako.eu

Wskazane jest przekładanie poszczególnych płytek, włącznie z ich obracaniem o 180° aż do osiągnięcia optymalnego wyglądu ściany, czy podłogi.

A burkolólápolak ragasztása előtt javasoljuk, hogy több dobozból vegye ki a burkolólápolakat és rakja ki a végleges mintázatot. A mintázat létrehozásához használhatják a RAKO katalógus inspiratív fényképeit vagy a www.rako.eu weblapon található képeket.

Kombinálja az egyes burkolólap elemeket igény szerint, illetve azokat 180°-kal is elforgathatja az optimális és harmónikus fal vagy padlóminták kialakításához.

Перед укладкой рекомендуется вынуть отдельные элементы плитки из нескольких картонных коробок и составить желаемый рисунок, исходя из разных примеров, указанных на фото в каталогах RAKO или на сайте www.rako.eu

Для достижения оптимального гармоничного вида облицовки стен или плиточного покрытия пола желательно комбинировать отдельные элементы, поворачивая их на 180°.

Antes de la colocación siempre recomendamos desembalar varias cajas y probar a colocar el material en la composición elegida en los catálogos de RAKO en las páginas de internet web www.rako.eu

Se recomienda la colocación de todos los posibles elementos de la decoración incluso girar los individualmente entre 180°, para conseguir la composición deseada y equilibrada del pavimento o revestimiento.

výrobek / product	cm	mm	EN	ks/m ²	m ²	kg	kg/m ²	brutto kg
obkládačka / wall tile	30x60	298x598x10	EN 14411:2016, annex L BIII GL	6	5,56	1,08	40	43,20
reliéfní listela / relief listel	60x6	598x60x10	STO č. 030 - 054498	4	27,8	0,14	-	2,6
mozaika set 30x30 cm / mosaic sheet 30x30 cm	5x5	48x48x10	STO č. 030 - 049913	3	11	0,27	-	5,0
dlaždice / floor tile	60x60	598x598x10	EN 14411:2016, annex G BIIa GL	3	2,8	1,08	32	34,56



WAKV4530
80 / m²
mat | matt



WAKV4531
80 / m²
mat | matt



WAKV4532
82 / m²
mat | matt



WAKV4533
82 / m²
mat | matt



WLRVD010
76 / ks
mat | matt



WLRVD011
76 / ks
mat | matt



WDM06530 (SET)
66 / set
mat | matt



WDM06531 (SET)
66 / set
mat | matt

bílá / white / biata / белый / fehér / blanco

šedá / grey / szara / серый / szürke / gris

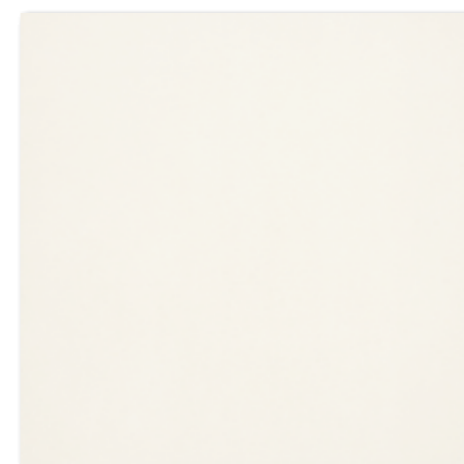

DAK63652
Trend
PEI 5 82 / m²
mat | matt

slonová kost / ivory / kość stoniowa
слоновая кость / elefántcsont / marfil



DAK63653
Trend
PEI 5 82 / m²
mat | matt

světle šedá / light grey / jasnoszara
светло-серый / világosszürke / gris claro





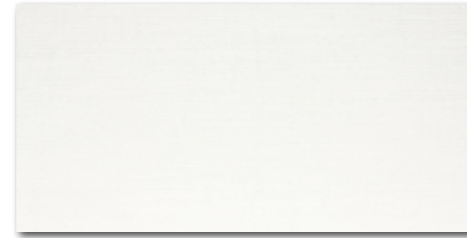

WARV4500
○ 84 / m²
mat | matt

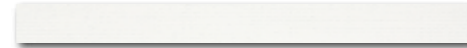

WLAVD500
○ 58 / ks
mat | matt



WDM06500 (SET)
○ 66 / set
mat | matt

světle šedá / light grey / jasnoszara
светло-серый / világosszürke / gris claro



WARV4503* 30x60
○ 86 / m²
mat | matt | **V4** | **R9**

vícebarevná / multicoloured / kolorowa
многочетный / többszínű / multicolor



WARV4501
○ 84 / m²
mat | matt



WLAVD501
○ 58 / ks
mat | matt



WDM06501 (SET)
○ 66 / set
mat | matt

šedá / grey / szara / серый / szürke / gris



DARSU719
Faro
PEI 5 ○ 84 / m²
mat | matt | **V4**

šedo-bílá / grey-white / szaro-biała
серый и белый / szürke és fehér / blanco-gris

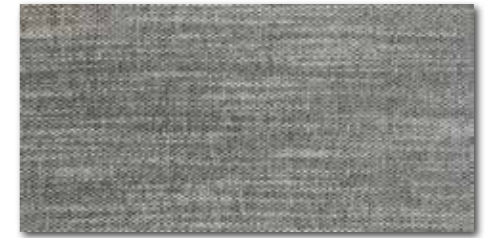

WARV4502
○ 84 / m²
mat | matt



WLAVD502
○ 58 / ks
mat | matt

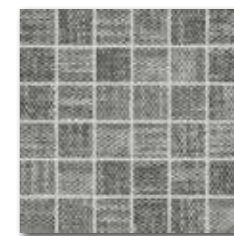

WDM06502 (SET)
○ 66 / set
mat | matt

tmavě šedá / dark grey / ciemnoszara
темно-серый / sötétszürke / gris oscuro



DAK63653
Trend
PEI 5 ○ 82 / m²
mat | matt | **V2**

světle šedá / light grey / jasnoszara
светло-серый / világosszürke / gris claro

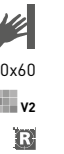

výrobek / product	cm	mm	EN	ks/m ²	m ²	m ²	m ²	kg	kg/m ²	brutto kg	
obkládačka / wall tile	30x60	298x598x10	EN 14411:2016, annex L BIII GL	6	5,56	1,08	40	43,20	20,0	18,5	825
listela / listel	60x5	598x48x10	EN 14411:2016, annex L BIII GL	11	33,3	0,33	-	-	6,1	18,5	-
mozaika set 30x30 cm / mosaic sheet 30x30 cm	5x5	48x48x10	STO č. 030 - 049913	3	11	0,27	-	-	5,0	18,5	-
dlaždice / floor tile	15x60	148x598x10	EN 14411:2016, annex G BIIa GL	10	11,1	0,9	48	43,20	19,4	21,5	954
dlaždice / floor tile	60x60	598x598x10	EN 14411:2016, annex G BIIa GL	3	2,8	1,08	32	34,56	24,9	23,0	820

*Balení výrobku obsahuje nahodilý mix zobrazených designů. | The products are deliberately mixed in packing to include a random selection of designs.



WARV4504
○ 84 / m²
mat | matt

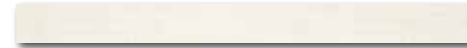

WLAVD504
○ 58 / ks
mat | matt

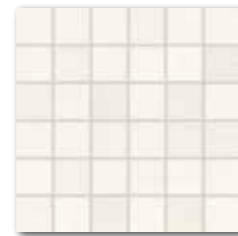

WDM06504 (SET)
○ 66 / set
mat | matt

světle béžová / light beige / jasnožółowa
светло-бежевый / világosbézs / beige claro



WARV4507* 30x60
○ 86 / m²
mat | matt | **V4** | **R9**
vícebarevná / multicoloured / kolorowa
многоцветный / többszínű / multicolor



WARV4505
○ 84 / m²
mat | matt



WLAVD505
○ 58 / ks
mat | matt



WDM06505 (SET)
○ 66 / set
mat | matt

běžová / beige / beżowa
бежевый / bézs / beige



WARV4506
○ 84 / m²
mat | matt



WLAVD506
○ 58 / ks
mat | matt



WDM06506 (SET)
○ 66 / set
mat | matt

hnědá / brown / brązowa
коричневый / barna / marrón



DARSU717
Faro
PEI 4 ○ 84 / m²
mat | matt | **V4**

světle hnědá / light brown / jasnobrązowa
светло-коричневый / világosbarna / marrón claro



DARSU718
Faro
PEI 4 ○ 84 / m²
mat | matt | **V4**

hnědá / brown / brązowa
коричневый / barna / marrón



DAR81720
Extra
PEI 5 ○ 94 / m²
mat | matt | **V2**

slonová kost / ivory / kość sloniowa
слоновая кость / elefántcsont / marfil

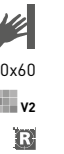

30x60

V2



60x5



30x30



V2



15x60

80x80



R9



A



výrobek / product	cm	mm	EN	ks/m ²	m ²	m ²	kg	kg/m ²	brutto kg		
obkládačka / wall tile	30x60	298x598x10	EN 14411:2016, annex L BIII GL	6	5,56	1,08	40	43,20	20,0	18,5	825
listela / listel	60x5	598x48x10	EN 14411:2016, annex L BIII GL	11	33,3	0,33	-	-	6,1	18,5	-
mozaika set 30x30 cm / mosaic sheet 30x30 cm	5x5	48x48x10	STO č. 030 - 049913	3	11	0,27	-	-	5,0	18,5	-
dlaždice / floor tile	15x60	148x598x10	EN 14411:2016, annex G BIIa GL	10	11,1	0,9	48	43,20	19,4	21,5	954
dlaždice / floor tile	80x80	798x798x10	EN 14411:2016, annex G BIIa GL	2	1,6	1,28	40	51,20	28,0	21,9	1 147

*Balení výrobku obsahuje nahodilý mix zobrazených designů. | The products are deliberately mixed in packing to include a random selection of designs.

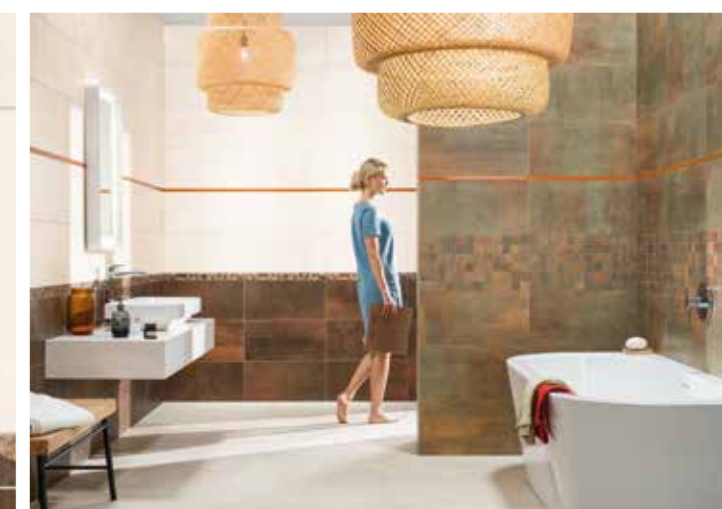
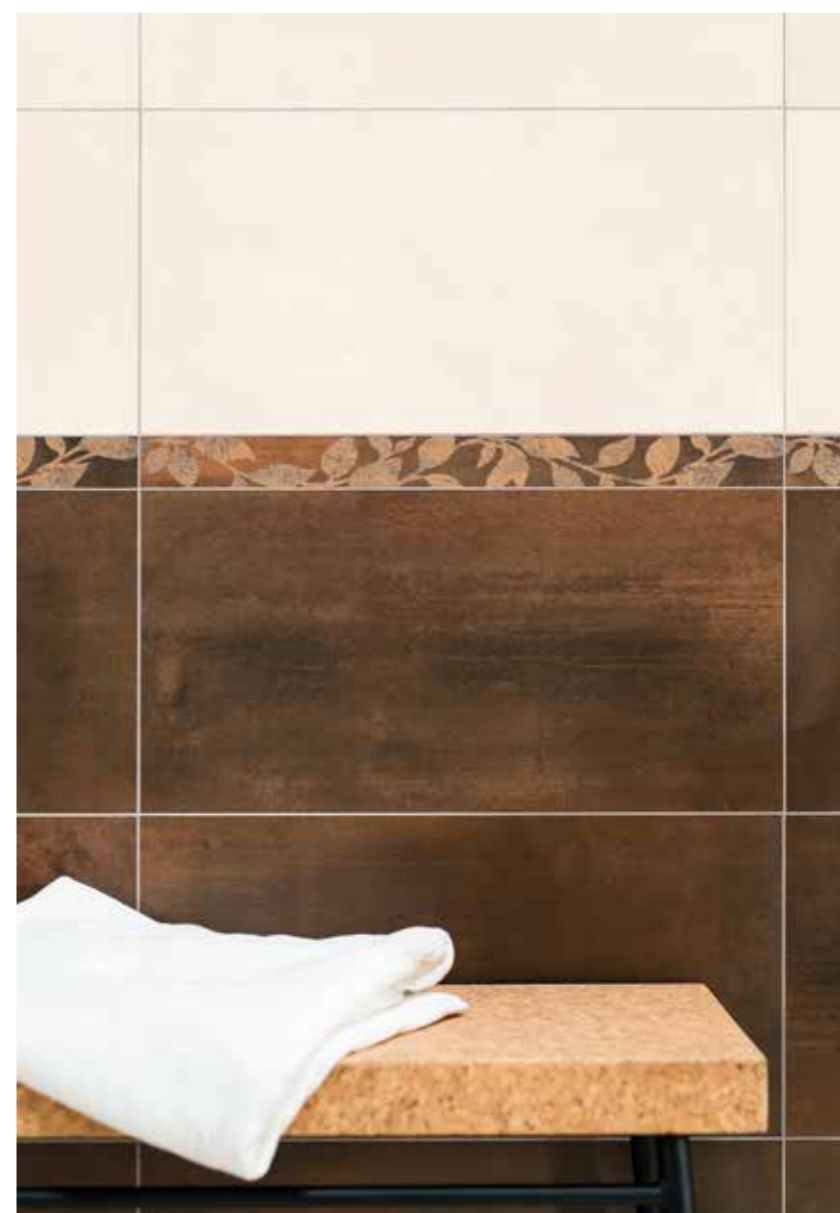

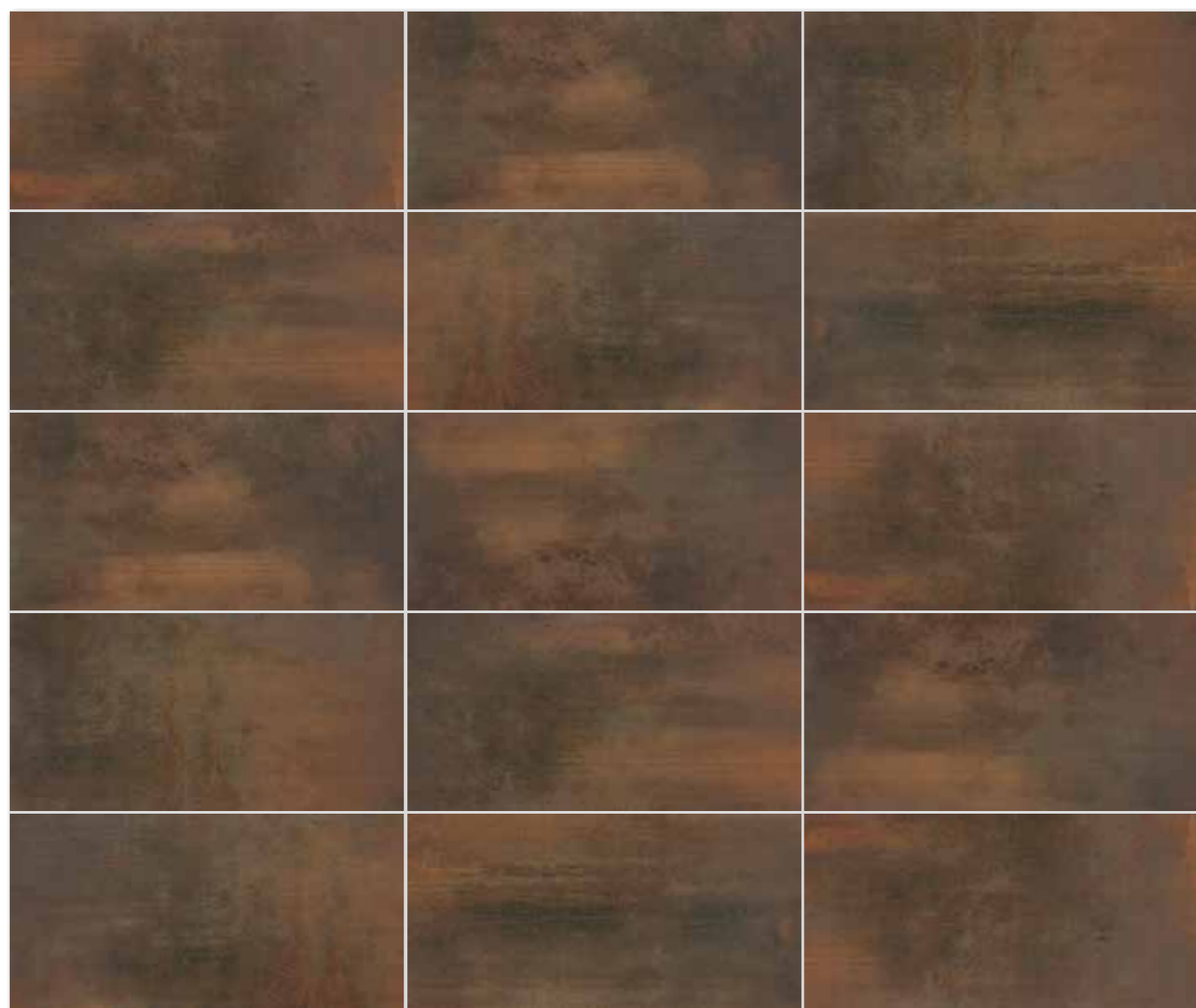

Všechny výrobky celé série vykazují velké odchylky odstínové difference V3/V4. / All products of the entire batch show big deviations in shade difference V3/V4.

Před pokládkou doporučujeme jednotlivé obkladové prvky vybrat z několika kartonů a výslednou plochu komponovat podle inspirativní fotodokumentace z katalogů RAKO případně z webových stránek www.rako.eu

Žádoucí je kombinace všech jednotlivých designů obkladových prvků včetně jejich natáčení o 180°, aby se dosáhlo optimálního vyváženého vzhledu podlahy nebo stěny.

Before laying the tiles, we suggest you select from several cartons and arrange them as illustrated in the inspiration photo documentation in RAKO catalogues or website www.rako.eu, and mix the tiles to achieve the required result including turning them by 180°.

Przed wyklejeniem zaleca się wyciągnąć płytki z kilku kartonów i rozłożyć na jednej powierzchni. Przy układaniu można się inspirować zdjęciami w katalogu lub na stronach internetowych www.rako.eu

Wskazane jest przekładanie poszczególnych płytek, włącznie z ich obracaniem o 180° aż do osiągnięcia optymalnego wyglądu ściany, czy podłogi.

A burkolólápok ragasztása előtt javasoljuk, hogy több dobozból vegye ki a burkolólápokokat és rakja ki a végleges mintázatot. A mintázat létrehozásához használhatja a RAKO katalógus inspiratív fényképeit vagy a www.rako.eu weblapon található képeket.

Kombinálja az egyes burkolólápol elemeket igény szerint, illetve azokat 180°-kal is elforgathatja az optimális és harmónikus fal vagy padló minta kialakításához.

Перед укладкой рекомендуется вынуть отдельные элементы плитки из нескольких картонных коробок и составить желаемый рисунок, исходя из разных примеров, указанных на фото в каталогах RAKO или на сайте www.rako.eu

Для достижения оптимального гармоничного вида облицовки стен или плиточного покрытия пола желательно комбинировать отдельные элементы, поворачивая их на 180°.

Antes de la colocación siempre recomendamos desembalar varias cajas y probar a colocar el material en la composición elegida en los catálogos de RAKO en las páginas de internet web www.rako.eu

Se recomienda la colocación de todos los posibles elementos de la decoración incluso girar los individualmente entre 180°, para conseguir la composición deseada y equilibrada del pavimento o revestimiento.

výrobek / product	cm	mm	EN	ks/m ²	m ²	kg	kg/m ²	brutto kg			
obkládačka / wall tile	30x60	298x598x10	EN 14411:2016, annex L BIII GL	6	5,56	1,08	40	43,20	20,0	18,5	825
listela / listel	60x2	598x20x10	EN 14411:2016, annex G BIIa GL	6	83,3	0,07	-	-	1,3	18,5	-
listela / listel	60x4,8	598x48x10	EN 14411:2016, annex L BIII GL	6	34,7	0,17	-	-	3,7	18,5	-
mozaika set 30x30 cm / mosaic sheet 30x30 cm	5x5	48x48x10	STO č. 030 - 049913	3	11	0,27	-	-	5,0	18,5	-
dlaždice / floor tile	80x80	798x798x10	EN 14411:2016, annex G BIIa GL	2	1,6	1,28	40	51,20	28,0	21,9	1.147



WAKV4518
 ○ 86 / m²
 mat/lesk | matt/glossy | **V3**
 světle béžová / light beige / jasnobežowa
 светло-бежевый / világosbézs / beige claro



WAKV4519
 ○ 86 / m²
 mat/lesk | matt/glossy | **V4**
 měděná / cupreous / miedź / медь / réz / cobre



WAKV4520
 ○ 86 / m²
 mat/lesk | matt/glossy | **V3**



DDRSN970
 Fashion
 ○ 78 / ks
 lesk | glossy
 oranžová / orange / pomarańczowa / оранжевый
 narancs / naranja



WLAVD520
 ○ 68 / ks
 mat/lesk | matt/glossy
 tmavě hnědá / dark brown / ciemnobrązowa
 темно-коричневый / sötétbarna / de color marrón oscuro

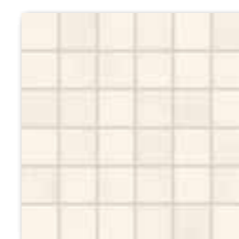

WDM06518 (SET)
 ○ 66 / set
 mat/lesk | matt/glossy | **V3**
 světle béžová / light beige / jasnobežowa
 светло-бежевый / világosbézs / beige claro



WDM06519 (SET)
 ○ 66 / set
 mat/lesk | matt/glossy | **V4**
 měděná / cupreous / miedź / медь / réz / cobre



WDM06520 (SET)
 ○ 66 / set
 mat/lesk | matt/glossy | **V3**
 tmavě hnědá / dark brown / ciemnobrązowa
 темно-коричневый / sötétbarna / de color marrón oscuro



DAR81720
 Extra
 PEI 5 ○ 94 / m²
 mat | matt
 slonová kost / ivory / kość słoniowa / слоновая кость / elefántcsont / marfil



WAKV4521
 ○ 86 / m²
 mat/lesk | matt/glossy
 svätle šedá / light grey / jasnozara
 светло-серый / világosszürke / gris claro



WAKV4522
 ○ 86 / m²
 mat/lesk | matt/glossy
 tmavě šedá / dark grey / ciemnoszara
 темно-серый / sötétszürke / gris oscuro



WAKV4523
 ○ 86 / m²
 mat/lesk | matt/glossy



DDRSN972
 ○ 78 / ks
 lesk | glossy
 svätle modrá / light blue / jasnoniebieska
 светло-голубой / világoskék / azul claro



WLAVD523
 ○ 68 / ks
 mat/lesk | matt/glossy
 černá / black / czarna / черный / fekete / negro



WDM06521 (SET)
 ○ 66 / set
 mat/lesk | matt/glossy
 svätle šedá / light grey / jasnozara
 светло-серый / világosszürke / gris claro



WDM06522 (SET)
 ○ 66 / set
 mat/lesk | matt/glossy
 tmavě šedá / dark grey / ciemnoszara
 темно-серый / sötétszürke / gris oscuro



WDM06523 (SET)
 ○ 66 / set
 mat/lesk | matt/glossy
 černá / black / czarna / черный / fekete / negro



DAR81722
 Extra
 PEI 5 ○ 94 / m²
 mat | matt
 bílá / white / biata / белый / fehér / blanco

výrobek / product	cm	mm	EN	ks/m ²	m ²	kg	kg/m ²	brutto kg			
obkládačka / wall tile	30x60	298x598x10	EN 14411:2016, annex L BIII GL	6	5,56	1,08	40	43,20	20,0	18,5	825
listela / listel	60x2	598x20x10	EN 14411:2016, annex G BIIa GL	6	83,3	0,07	-	-	1,3	18,5	-
listela / listel	60x4,8	598x48x10	EN 14411:2016, annex L BIII GL	6	34,7	0,17	-	-	3,7	18,5	-
mozaika set 30x30 cm / mosaic sheet 30x30 cm	5x5	48x48x10	STO č. 030 - 049913	3	11	0,27	-	-	5,0	18,5	-
dlaždice / floor tile	80x80	798x798x10	EN 14411:2016, annex G BIIa GL	2	1,6	1,28	40	51,20	28,0	21,9	1.147





Všechny výrobky celé série vykazují velké odchylky odstínové difference V4. / All products of the entire batch show big deviations in shade difference V4.

Před pokládkou doporučujeme jednotlivé obkladové prvky vybírat z několika kartonů a výslednou plochu komponovat podle inspirativní fotodokumentace z katalogů RAKO případně z webových stránek www.rako.cz
Žádoucí je kombinace všech jednotlivých designů obkladových prvků včetně jejich natáčení o 180°, aby se dosáhlo optimálního vyváženého vzhledu podlahy nebo stěny.

Before laying the tiles, we suggest you select from several cartons and arrange them as illustrated in the inspiration photo documentation in RAKO catalogues or website www.rako.eu, and mix the tiles to achieve the required result including turning them by 180°.

Przed wyklejeniem zaleca się wyciągnąć płytki z kilku kartonów i rozłożyć na jednej powierzchni. Przy układaniu można się inspirować zdjęciami w katalogu lub na stronach internetowych www.rako.eu

Wskazane jest przekładanie poszczególnych płytek, włącznie z ich obracaniem o 180° aż do osiągnięcia optymalnego wyglądu ściany, czy podłogi.

A burkolólapok ragasztása előtt javasoljuk, hogy több dobozból vegye ki a burkolólapokat és rakja ki a végleges mintázatot. A mintázat létrehozásához használhatja a RAKO katalógus inspiratív fényképeit vagy a www.rako.eu weblapon található képeket.
Kombinálja az egyes burkolólap elemeket igény szerint, illetve azokat 180°-kal is elforgathatja az optimális és harmónikus fal vagy padlóminták kialakításához.

Перед укладкой рекомендуется вынуть отдельные элементы плитки из нескольких картонных коробок и составить желаемый рисунок, исходя из разных примеров, указанных на фото в каталогах RAKO или на сайте www.rako.eu

Для достижения оптимального гармоничного вида облицовки стен или плиточного покрытия пола желательно комбинировать отдельные элементы, поворачивая их на 180°.

Antes de la colocación siempre recomendamos desembalar varias cajas y probar a colocar el material en la composición elegida en los catálogos de RAKO en las páginas de internet web www.rako.eu

Se recomienda la colocación de todos los posibles elementos de la decoración incluso girar los individualmente entre 180°, para conseguir la composición deseada y equilibrada del pavimento o revestimiento.

výrobek / product	cm	mm	EN	ks/m ²	m ²	kg	kg/m ²	brutto kg
obkládačka / wall tile	20x60	198x598x10	EN 14411:2016, annex L BIII GL	9	8,3	1,08	42	45,36
listela / listel (set)	60x4,5	598x45x10	EN 14411:2016, annex L BIII GL	2	12,3	0,16	-	3,0
mozaika set 30x30 cm / mosaic sheet 30x30 cm	5x5	48x48x10	STO č. 030 - 049913	3	11	0,27	-	5,0
dlaždice / floor tile	60x60	598x598x10	EN 14411:2016, annex G BIIa GL	3	2,8	1,08	32	34,56

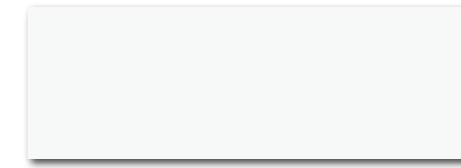
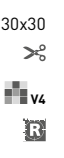

WAAVE000
78 / m²
lesk | glossy | V1
bílá / white / biata / белый / fehér / blanco



WADVE515
76 / m²
lesk | glossy | V4
světle béžová / light beige / jasnobežowa
светло-бежевый / világosbézs / beige claro



WADVE516
76 / m²
lesk | glossy | V4
béžová / beige / bežowa
бежевый / bézs / beige



WLAVD518
88 / set
lesk | glossy
vícetbarevná / multicoloured / kolorowa / многоцветный
többszínű / multicolor



WADVE517
76 / m²
lesk | glossy | V4
hnědá / brown / brązowa
коричневый / barna / marrón



WDM06515 (SET)
66 / set
lesk | glossy
světle béžová / light beige
jasnobežowa / светло-бежевый
világosbézs / beige claro



WDM06516 (SET)
66 / set
lesk | glossy
béžová / beige / bežowa
бежевый / bézs / beige



WDM06517 (SET)
66 / set
lesk | glossy
hnědá / brown / brązowa
коричневый / barna / marrón



DAK63431
Base
PEI 5
86 / m²
mat | matt
světle béžová / light beige / jasnobežowa / светло-бежевый
világosbézs / beige claro



WADM534
○ 72 / m²
mat | matt

bílá / white / biata / белый
fehér / blanco



WADM535
○ 72 / m²
mat | matt

běžová / beige / bežowa
бежевый / bézs / beige



WADM536
○ 72 / m²
mat | matt

světle šedá / light grey / jasnoszara
светло-серый / világosszürke / gris claro



WADM537
○ 72 / m²
mat | matt

šedá / grey / szara / серый
szürke / gris



WADM538
○ 78 / m²
mat | matt | V4

vicebarevná / multicoloured / kolorowa
многоцветный / többszínű / multicolor

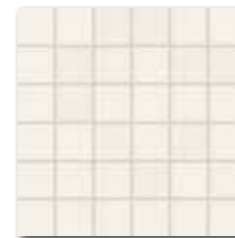

WDM05534 (SET)
○ 66 / set
mat | matt

bílá / white / biata / белый
fehér / blanco



WDM05535 (SET)
○ 66 / set
mat | matt

běžová / beige / bežowa
бежевый / bézs / beige



WDM05536 (SET)
○ 66 / set
mat | matt

světle šedá / light grey / jasnoszara
светло-серый / világosszürke / gris claro

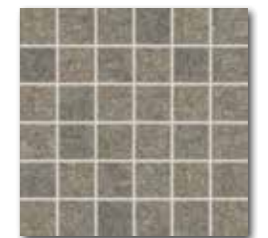

WDM05537 (SET)
○ 66 / set
mat | matt

šedá / grey / szara / серый
szürke / gris



DARSU718
Faro

PEI 4 ○ 84 / m²
mat | matt | R9

hnědá / brown / brązowa / коричневый / barna / marrón



DAR3B692
Como

PEI 5 ○ 74 / m²
mat | matt

bílá / white / biata / белый / fehér / blanco



výrobek / product	cm	mm	EN	ks/m ²	m ²	m ²	kg	kg/m ²	brutto kg		
obkladáčka / wall tile	20x40	198x398x7	EN 14411:2016, annex L BIII GL	20	12,5	1,60	48	76,80	20,6	12,9	1 016
mozaika set 30x30 cm / mosaic sheet 30x30 cm	5x5	48x48x10	STO č. 030 - 049913	3	11	0,27	-	-	3,5	12,9	-
dlaždice / floor tile	15x60	148x598x10	EN 14411:2016, annex G BIIa GL	10	11,1	0,9	48	43,20	19,4	21,5	954
dlaždice / floor tile	33x33	333x333x8	EN 14411:2016, annex G BIIa GL	12	9	1,33	44	58,52	23,6	17,7	1 061



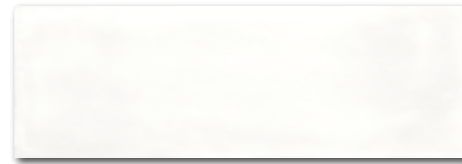

WARVE043
○ 82 / m²
lesk | glossy

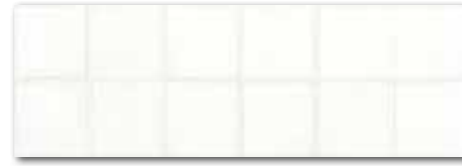

WARVE143
○ 82 / m²
lesk | glossy

bílá / white / biata / белый / fehér / blanco



WARVE146*
○ 86 / m²
lesk | glossy

modrá / blue / niebieska / голубой / kék / azul

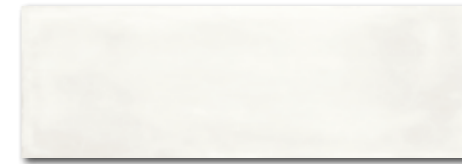

WARVE044
○ 82 / m²
lesk | glossy

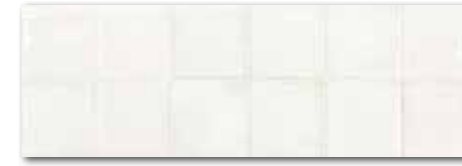

WARVE144
○ 82 / m²
lesk | glossy

světle šedá / light grey / jasnoszara
светло-серый / világosszürke / gris claro



WARVE147*
○ 86 / m²
lesk | glossy

šedá / grey / szara / серый / szürke / gris



DAR34711
Via
PEI 4 ○ 74 / m²
mat | matt

šedá / grey / szara / серый / szürke / gris



WARVE045
○ 82 / m²
lesk | glossy



WARVE145
○ 82 / m²
lesk | glossy

světle béžová / light beige / jasnobežowa
светло-бежевый / világosbézs / beige claro

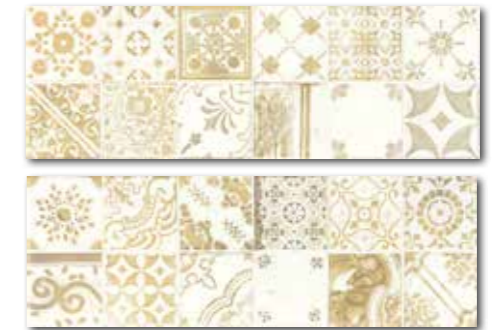

WARVE148*
○ 86 / m²
lesk | glossy

běžová / beige / bežowa / бежевый / bézs / beige



DAR34712
Via
PEI 4 ○ 74 / m²
mat | matt

červeno-hnědá / red-brown
czerwono-brązowy / красно-коричневый
vörösesbarna / de color marrón gojzo



výrobek / product



20x60



30x30

198x598x10

298x298x8

EN

EN 14411:2016, annex L BIII GL

EN 14411:2016, annex G BIIa GL



9



13



1,08

1,18



42

48



45,36

56,64



20,0

21,0



18,5

17,8



865

1 034

*Balení výrobku obsahuje nahodilý mix zobrazených designů. | The products are deliberately mixed in packing to include a random selection of designs.

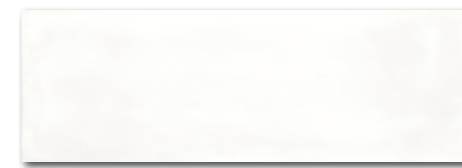

WARVE043
 ○ 82 / m²
 lesk | glossy | ✨
 bílá / white / biata / белый / fehér / blanco

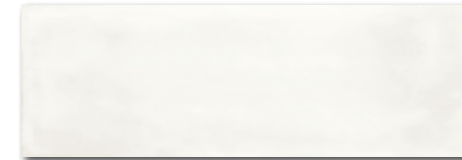

WARVE044
 ○ 82 / m²
 lesk | glossy | ✨
 světle šedá / light grey / jasnoszara
 светло-серый / világosszürke / gris claro



WARVE045
 ○ 82 / m²
 lesk | glossy | ✨
 světle béžová / light beige / jasnobežowa
 светло-бежевый / világosbézs / beige claro



WITVE008 (SET)
 ○ 90 / set
 lesk | glossy



WLAVH008
 ○ 48 / ks
 lesk | glossy
 vícebarevná / multicoloured / kolorowa
 многоцветный / többszínű / multicolor



DAR34712
 Via
 PEI 4 ○ 74 / m²
 mat | matt
 červeno-hnědá / red-brown
 czerwono-brązowy / красно-коричневый
 vörösesbarna / de color marrón rojizo



DDT8712 (SET)
 Via
 PEI 4 ○ 74 / set
 mat | matt | >= | R9



20x60
v3

60x3,5



30x30
21x37
R9
A
V4

výrobek / product	cm	mm	EN	ks/m ²	m ²	m ³	kg	kg/m ²	brutto kg		
obkládačka / wall tile	20x60	198x598x10	EN 14411:2016, annex L BIII GL	9	8,3	1,08	42	45,36	20,0	18,5	865
inzerťo (set) / insert (set)	20x60	198x598x10	EN 14411:2016, annex L BIII GL	3	8,3	0,72	-	-	13,3	18,5	-
listela / listel	60x3,5	598x35x10	EN 14411:2016, annex L BIII GL	6	47,6	0,13	-	-	2,7	18,5	-
dekor set 21x37 cm / decor sheet 21x37 cm	12/7	120/70x8	EN 14411:2016, annex G BIIa GL	5	13,1	0,38	-	-	6,8	17,8	-
dlaždice / floor tile	30x30	298x298x8	EN 14411:2016, annex G BIIa GL	13	11	1,18	48	56,64	21,0	17,8	1 034

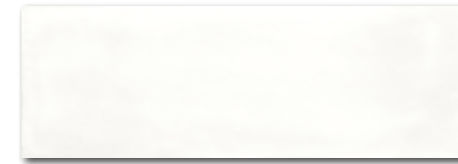

WARVE043
 ○ 82 / m²
 lesk | glossy | ✨
 bílá / white / biata / белый / fehér / blanco

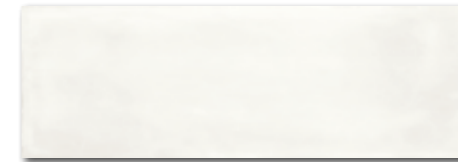

WARVE044
 ○ 82 / m²
 lesk | glossy | ✨
 světle šedá / light grey / jasnoszara
 светло-серый / világosszürke / gris claro

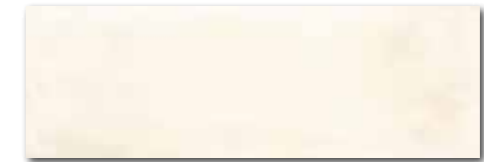

WARVE045
 ○ 82 / m²
 lesk | glossy | ✨
 světle béžová / light beige / jasnobežowa
 светло-бежевый / világosbézs / beige claro



WITVE009 (SET)
 ○ 90 / set
 lesk | glossy



WLASZ009
 ○ 68 / ks
 lesk | glossy
 vícebarevná / multicoloured / kolorowa
 многоцветный / többszínű / multicolor



DAKVG141
 Board
 PEI 5 ○ 98 / m²
 mat | matt
 světle béžová / light beige / jasnobežowa / светло-бежевый / világosbézs / beige claro



DAKVG142
 Board
 PEI 4 ○ 98 / m²
 mat | matt
 béžová / beige / bežowa / бежевый / bézs / beige



20x60
v3

60x6



20x120

výrobek / product	cm	mm	EN	ks/m ²	m ²	m ³	kg	kg/m ²	brutto kg		
obkladáčka / wall tile	20x60	198x598x10	EN 14411:2016, annex L BIII GL	9	8,3	1,08	42	45,36	20,0	18,5	865
inzerito (set) / insert (set)	20x60	198x598x10	EN 14411:2016, annex L BIII GL	3	8,3	0,72	-	-	13,3	18,5	-
listela / listel	60x6	598x60x10	EN 14411:2016, annex L BIII GL	6	27,8	0,22	-	-	4,1	18,5	-
dlaždice / floor tile	20x120	197x1198x10	EN 14411:2016, annex G BIIa GL	4	4,2	0,96	33	31,68	21,3	22,2	729





20x60



WADVE033
 ○ 82 / m²
 mat | matt | **V3** |



WADVE034
 ○ 82 / m²
 mat | matt | **V3** |



WADVE035
 ○ 82 / m²
 mat | matt | **V4** |



WITVE033 (SET)
 ○ 90 / set
 mat | matt
 béžová / beige / beżowa / бежевый / bézs / beige



WADVE036
 ○ 82 / m²
 mat | matt | **V3** |



WADVE037
 ○ 82 / m²
 mat | matt | **V3** |



WADVE038
 ○ 82 / m²
 mat | matt | **V4** |



WITVE036 (SET)
 ○ 90 / set
 mat | matt
 šedá / grey / szara / серый / szürke / gris

60x8,7



WLASP035
 ○ 80 / ks
 mat/lesk | matt/glossy
 svätle béžová / light beige / jasnobeżowa
 светло-бежевый / világosbézs / beige claro



WLASP038
 ○ 80 / ks
 mat/lesk | matt/glossy
 svätle šedá / light grey / jasnoszara
 светло-серый / világosszürke / gris claro

60x1,5



WLASW001
 ○ 58 / ks
 mat | matt
 oranžová / orange / romańańcowa / оранжевый
 narancs / naranja



WLASW003
 ○ 58 / ks
 mat | matt
 červená / red / czerwona / красный / piros / rojo



WLASW002
 ○ 58 / ks
 mat | matt
 bordo / bordo / bordowa / бордо / borvörös / bordo



WLASW004
 ○ 58 / ks
 mat | matt
 fialová / violet / fioletowa / сиреневый / lila / púrpura

30x30

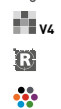

WDM06035 (SET)
 ○ 66 / set
 mat | matt

béžová / beige / beżowa / бежевый / bézs / beige



WDM06038 (SET)
 ○ 66 / set
 mat | matt

šedá / grey / szara / серый / szürke / gris



20x60

60x8,7

60x1,5

30x30



60x60

R9

V2



výrobek / product	cm	mm	EN	ks/m ²	m ²	kg	brutto kg
obkládačka / wall tile	20x60	198x598x10	EN 14411:2016, annex L BIII GL	9	8,3	1,08	42
inzerťo / insert (set)	20x60	198x598x10	EN 14411:2016, annex L BIII GL	3	8,3	0,72	13,3
listela / listel	60x8,7	598x87x10	EN 14411:2016, annex L BIII GL	5	19,2	0,26	5,1
listela / listel	60x1,5	598x15x10	EN 14411:2016, annex L BIII GL	10	111,1	0,09	1,6
mozaika set 30x30 cm / mosaic sheet 30x30 cm	5x5	48x48x10	STO č. 030 - 049913	3	11	0,27	5,0
dlaždice / floor tile	60x60	598x598x10	EN 14411:2016, annex G BIIa GL	3	2,8	1,08	32

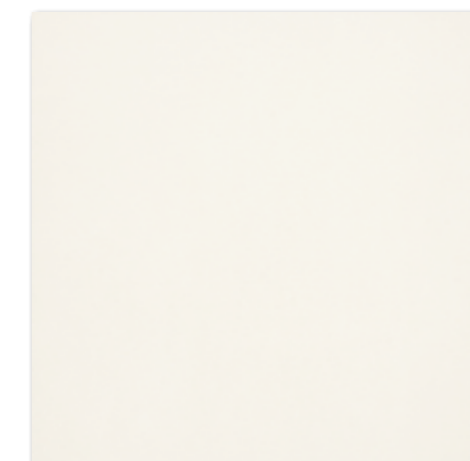

DAK63652
 Trend
 PEI 5 ○ 82 / m²
 mat | matt
 slonová kost / ivory / kość słoniowa / слоно́вая ко́сть
 elefántcsont / marfil





20x60

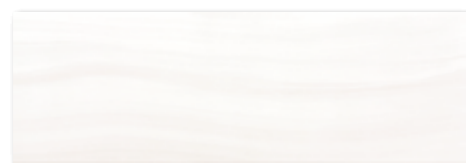

WADVE039
82 / m²
lesk | glossy



WADVE040
82 / m²
lesk | glossy

30x30



WDM06039 (SET)
66 / set
lesk | glossy



WDM06040 (SET)
66 / set
lesk | glossy

60x1,3



WLASW050
Tendence
58 / ks
lesk | glossy

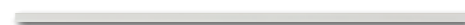

WLASW051
Tendence
58 / ks
lesk | glossy
světle šedá / light grey / jasnoszara
светло-серый / világosszürke / gris claro



45x45



DAK44182
Spirit
PEI 5 82 / m²
mat/lesk | matt/glossy
bílá / white / biata / белый / fehér / blanco



WADVE041
82 / m²
lesk | glossy



WADVE042
82 / m²
lesk | glossy

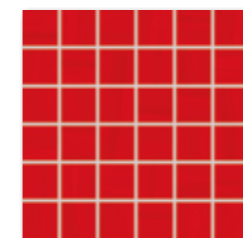

WDM06041 (SET)
66 / set
lesk | glossy

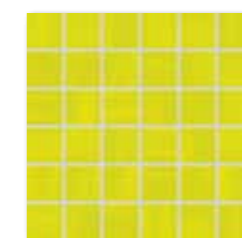

WDM06042 (SET)
66 / set
lesk | glossy



WLASW053
Tendence
58 / ks
lesk | glossy
červená / red / czerwona / красный / piros / rojo



WLASW057
Tendence
58 / ks
lesk | glossy
zelená / green / zielona / зеленый / zöld / verde



WITVE004 (SET)
90 / set
mat/lesk | matt/glossy



WITVE003 (SET)
90 / set
mat/lesk | matt/glossy



WLASZ004
68 / ks
lesk | glossy
červeno-oranžová / red-orange / czerwony-pomarańczowy
красно-оранжевый / vörös-narancs / rojo-naranja



WLASZ003
68 / ks
lesk | glossy
červeno-zelená / red-green / czerwony-zielony
красный-зеленый / piros-zöld / rojo-verde



DAKVG144
Board
PEI 4 98 / m²
mat | matt
tmavě hnědá / dark brown / ciemnobrązowa / темно-коричневый / sötétbarna / de color marrón oscuro



DAKVG143
Board
PEI 4 98 / m²
mat | matt
hnědá / brown / brązowa / коричневый / barna / marrón



20x60



30x30



60x1,3

20x60

60x5,5



20x120



výrobek / product	cm	mm	EN	ks/m ²	m ²	kg	brutto kg				
obkládací / wall tile	20x60	198x598x10	EN 14411:2016, annex L BIII GL	9	8,3	1,08	42	45,36	20,0	18,5	865
inzerťo / insert (set)	20x60	198x598x10	EN 14411:2016, annex L BIII GL	3	8,3	0,72	-	-	13,3	18,5	-
listela / listel	60x5,5	598x55x10	EN 14411:2016, annex L BIII GL	6	30,3	0,20	-	-	3,9	19,5	-
listela / listel	60x1,3	598x13x10	EN 14411:2016, annex L BIII GL	10	128,2	0,08	-	-	1,4	17,5	-
mozaika set 30x30 cm / mosaic sheet 30x30 cm	5x5	48x48x10	STO No. 030 - 049913	3	11	0,27	-	-	5,0	18,5	-
dlaždice / floor tile	20x120	197x1198x10	EN 14411:2016, annex G BIIa GL	4	4,2	0,96	33	31,68	21,3	22,2	729
dlaždice / floor tile	45x45	445x445x10	EN 14411:2016, annex G BIIa GL	6	5	1,21	26	31,46	25,0	20,7	677



20x60
v2



WATVE050
76 / m²
mat/lesk | matt/glossy



WATVE051
76 / m²
mat/lesk | matt/glossy



WATVE056
76 / m²
mat/lesk | matt/glossy



WATVE055
76 / m²
mat/lesk | matt/glossy

60x1,3



WLAW050
58 / ks
lesk | glossy
bilá / white / biata / белый / fehér / blanco

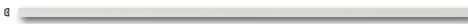

WLAW051
58 / ks
lesk | glossy
světle šedá / light grey / jasnoszara / ветло-серый
világosszürke / gris claro



WLAW056
58 / ks
lesk | glossy
oranžová / orange / pomarańczowa / оранжевый
narancs / naranja



WLAW055
58 / ks
lesk | glossy
fialová / violet / fioletowa / сиреневый / lila / púrpura

20x60
v2



WATVE052
76 / m²
mat/lesk | matt/glossy

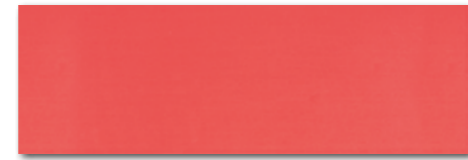

WATVE053
76 / m²
mat/lesk | matt/glossy

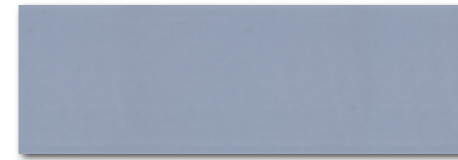

WATVE054
76 / m²
mat/lesk | matt/glossy

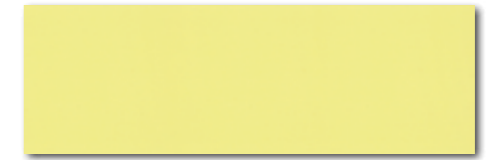

WATVE057
76 / m²
mat/lesk | matt/glossy

60x1,3



WLAW052
58 / ks
lesk | glossy
černá / black / czarna / черный / fekete / negro



WLAW053
58 / ks
lesk | glossy
červená / red / czerwona / красный / piros / rojo



WLAW054
58 / ks
lesk | glossy
modrá / blue / niebieska / голубой / kék / azul



WLAW057
58 / ks
lesk | glossy
zelená / green / zielona / зеленый / zöld / verde

20x60
v2

60x1,3

20x60
v2

60x1,3





30x30

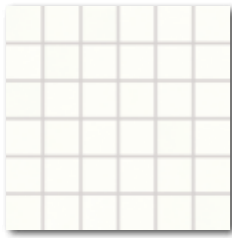

WDM06050 [SET]
 66 / set
 mat/lesk | matt/glossy | **V2**
 bilá / white / biata / белый / fehé / blanco



WDM06051 [SET]
 66 / set
 mat/lesk | matt/glossy | **V2**
 svetle šedá / light grey / jasnoszara / vetlo-серый / világosszürke / gris claro

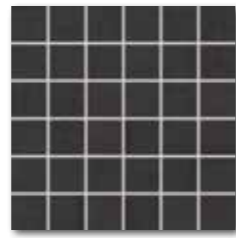

WDM06052 [SET]
 66 / set
 mat/lesk | matt/glossy | **V2**
 černá / black / czarna / черный / fekete / negro

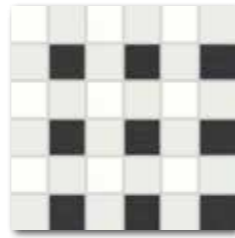

WDM06152 [SET]
 66 / set
 mat/lesk | matt/glossy | **V4**

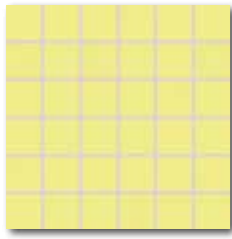

WDM06057 [SET]
 66 / set
 mat/lesk | matt/glossy | **V2**
 zelená / green / zielona / зеленый / zöld / verde

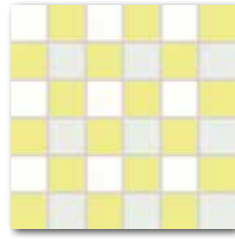

WDM06157 [SET]
 66 / set
 mat/lesk | matt/glossy | **V4**

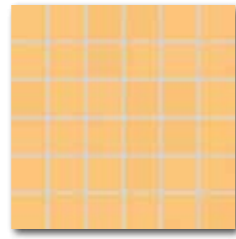

WDM06056 [SET]
 66 / set
 mat/lesk | matt/glossy | **V2**
 oranžová / orange / pomarańczowa / оранжевый / narancs / naranja

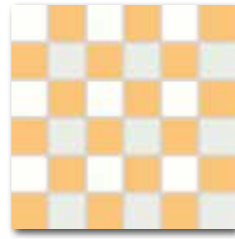

WDM06156 [SET]
 66 / set
 mat/lesk | matt/glossy | **V4**



WDM06055 [SET]
 66 / set
 mat/lesk | matt/glossy | **V2**
 fialová / violet / fioletowa / сиреневый / tifa / púrpura

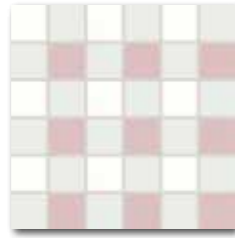

WDM06155 [SET]
 66 / set
 mat/lesk | matt/glossy | **V4**

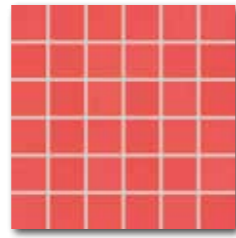

WDM06053 [SET]
 66 / set
 mat/lesk | matt/glossy | **V2**
 červená / red / czerwona / красный / piros / rojo

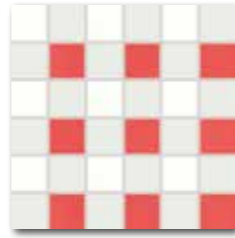

WDM06153 [SET]
 66 / set
 mat/lesk | matt/glossy | **V4**

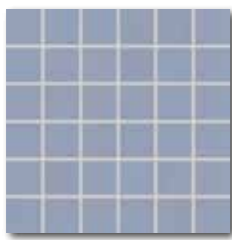

WDM06054 [SET]
 66 / set
 mat/lesk | matt/glossy | **V2**
 modrá / blue / niebieska / голубой / kék / azul

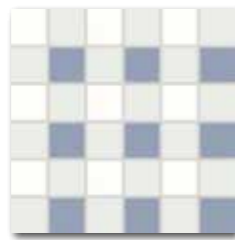

WDM06154 [SET]
 66 / set
 mat/lesk | matt/glossy | **V4**

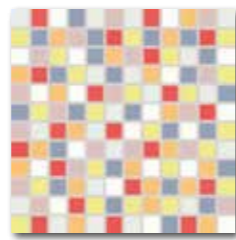

WDM02001 [SET]
 78 / set
 mat/lesk | matt/glossy | **V4**
 vícebarevná / multicoloured / kolorowa / многоцветный / többszínű / multicolor



WITVE005 [SET]
 90 / set
 mat/lesk | matt/glossy



WLASZ005 [SET]
 64 / ks
 mat/lesk | matt/glossy
 černo-bílá / black-white / czarno-biały / черный и белый / fekete-fehér / en negro y blanco

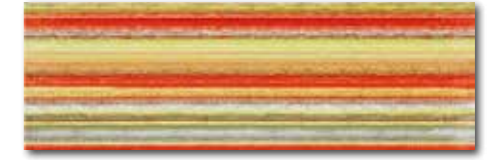

WITVE006
 76 / ks
 lesk | glossy



WLASZ003 [SET]
 Air
 68 / ks
 lesk | glossy
 červeno-zelená / red-green / czerwony-zielony / красный-зеленый / piros-zöld / gojo-verde



WITVE007
 76 / ks
 lesk | glossy

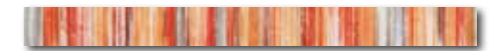

WLASZ004 [SET]
 Air
 68 / ks
 lesk | glossy
 červeno-oranžová / red-orange / czerwony-pomarańczowy / красно-оранжевый / vörös-narancs / gojo-naranja



DAKVG143
 Board
 PEI 4 98 / m²
 mat | matt
 hnědá / brown / brązowa / коричневый / barna / marrón

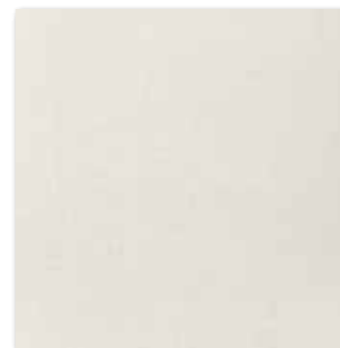

DAK44182
 Spirit
 PEI 5 82 / m²
 mat/lesk | matt/glossy
 bílá / white / biata / белый / fehé / blanco



DAK44185
 Spirit
 PEI 5 82 / m²
 mat/lesk | matt/glossy
 šedá / grey / szara / серый / szürke / gris



DAK44187
 Spirit
 PEI 4 82 / m²
 mat/lesk | matt/glossy
 černá / black / czarna / черный / fekete / negro



20x60



20x120



45x45



60x45



60x60



60x60



60x60



60x60



60x60

výrobek / product	cm	mm	EN	ks/m ²	m ²	m ²	kg	kg/m ²	brutto kg		
obkládací / wall tile	20x60	198x598x10	EN 14411:2016, annex L BIII GL	9	8,3	1,08	42	45,36	20,0	18,5	865
listela / listel	60x1,3	598x13x10	EN 14411:2016, annex L BIII GL	10	128,2	0,08	-	-	1,4	17,5	-
mozaika set 30x30 cm / mosaic sheet 30x30 cm	5x5	48x48x10	STO č. 030 - 049913	3	11	0,27	-	-	5,0	18,5	-
mozaika set 30x30 cm / mosaic sheet 30x30 cm	2,5x2,5	23x23x10	STO č. 030 - 049913	3	11	0,27	-	-	5,0	18,5	-
inzerťo / insert (set)	20x60	198x598x10	EN 14411:2016, annex L BIII GL	3	8,3	0,72	-	-	13,3	18,5	-
inzerťo / insert	20x60	198x598x10	EN 14411:2016, annex L BIII GL	6	8,3	0,72	-	-	13,3	18,5	-
listela / listel	60x4,5	598x45x10	EN 14411:2016, annex L BIII GL	6	37	0,20	-	-	3,1	19,4	-
listela / listel	60x5,5	598x55x10	EN 14411:2016, annex L BIII GL	6	30,3	0,16	-	-	3,9	19,5	-
dlaždice / floor tile	20x120	197x198x10	EN 14411:2016, annex G BIIa GL	4	4,2	0,96	33	31,68	21,3	22,2	729
dlaždice / floor tile	45x45	445x445x10	EN 14411:2016, annex G BIIa GL	6	5	1,21	26	31,46	25,0	20,7	677

20x60



20x60



20x60



20x60



20x60



20x60

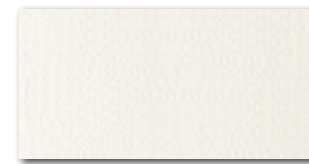

WADMB090
○ 68 / m²
lesk | glossy



WLAN9090
○ 56 / ks
lesk | glossy

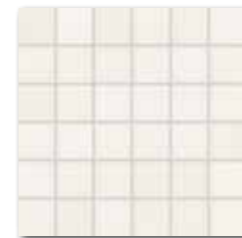

WDM05090 (SET)
○ 66 / set
lesk | glossy
bílá / white / biata / белый
fehér / blanco



WADMB093
○ 74 / m²
lesk | glossy



WLAN9093
○ 56 / ks
lesk | glossy

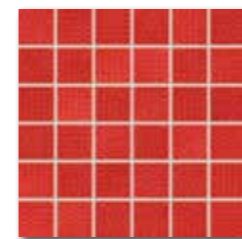

WDM05093 (SET)
○ 66 / set
lesk | glossy | **V2**
červená / red / czerwona
красный / piros / rojo

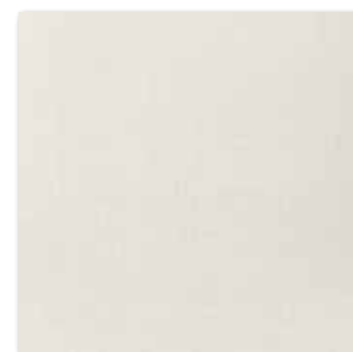

DAK44182
Spirít
PEI 5 ○ 82 / m²
mat/lesk | matt/glossy
bílá / white / biata / белый / fehér / blanco



WADMB091
○ 74 / m²
lesk | glossy



WLAN9091
○ 56 / ks
lesk | glossy



WDM05091 (SET)
○ 66 / set
lesk | glossy
tyrkysová / turquoise / turkus
бирюзовый / türkiz / turquesa



WADMB094
○ 74 / m²
lesk | glossy



WLAN9094
○ 56 / ks
lesk | glossy

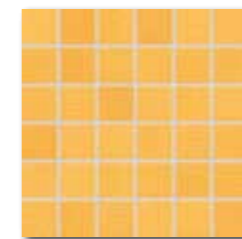

WDM05094 (SET)
○ 66 / set
lesk | glossy | **V2**
oranžová / orange / pomarańczowy
оранжевый / narancs / naranja



WADMB092
○ 74 / m²
lesk | glossy



WLAN9092
○ 56 / ks
lesk | glossy

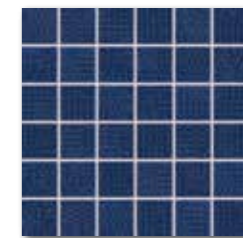

WDM05092 (SET)
○ 66 / set
lesk | glossy
tmavě modrá / dark blue / ciemnoniebieski
темно-синий / sötétkék / azul oscuro



WDM05095 (SET)
○ 66 / set
lesk | glossy | **V4**
vícebarevná / multicoloured / kolorowa
многоцветный / többszínű / multicolor



20x40



V2

40x3,5

30x30



V2



V4

20x40



V2

40x3,5

30x30



V4



45x45



R9



V2



V4

výrobek / product	cm	mm	EN	ks/m ²	m ²	m ³	kg	kg/m ²	brutto kg	
obkládačka / wall tile	20x40	198x398x7	EN 14411:2016, annex L BIII GL	20	12,5	1,60	48	76,80	20,6	1 016
listela / listel	40x3,5	398x35x7	EN 14411:2016, annex L BIII GL	12	71,4	0,17	-	-	2,6	14,4
mozaika set 30x30 cm / mosaic sheet 30x30 cm	5x5	48x48x7	STO č. 030 - 049913	3	11	0,27	-	-	3,5	12,9
dlaždice / floor tile	20x120	197x1198x10	EN 14411:2016, annex G BIIa GL	4	4,2	0,96	33	31,68	21,3	22,2
dlaždice / floor tile	45x45	445x445x10	EN 14411:2016, annex G BIIa GL	6	5	1,21	26	31,46	25,0	677

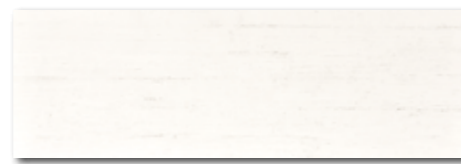

WADVE020
○ 76 / m²
mat | matt | ✨
bílá / white / biala / белый / fehér / blanco

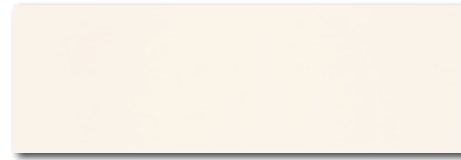

WATVE022
○ 76 / m²
mat | matt



WITVE022 (SET)
○ 92 / set
mat | matt
světle béžová / light beige / jasnobeżowa
светло-бежевый / világosbézs / beige claro

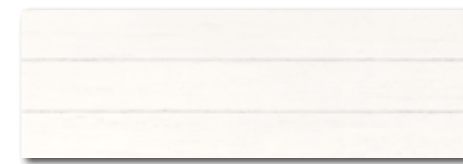

WADVE021
○ 82 / m²
mat | matt | ✨
bílá / white / biala / белый / fehér / blanco

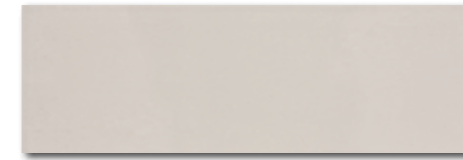

WATVE023
○ 76 / m²
mat | matt



WITVE023 (SET)
○ 92 / set
mat | matt
šedoběžová / grey-beige / szaro-beżowa
серо-бежевый / szürke-bézs / gris-amarillento



DAK63653
Trend
PEI 5 ○ 82 / m²
mat | matt
světle šedá / light grey / jasnoszara
светло-серый / világosszürke / gris claro

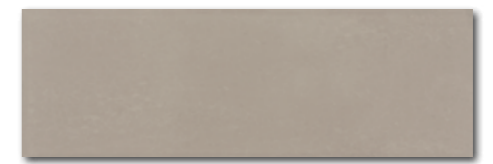

WATVE024
○ 76 / m²
mat | matt
hnědošedá / brown-grey / brązowoszara
коричневый-серый / szürke-barna / marrón-gris



WATVE025
○ 76 / m²
mat | matt



WLASZ125 60x3,5
○ 64 / ks
mat | matt
zelená / green / zielona / зеленый / zold / verde



WATVE026
○ 76 / m²
mat | matt



WLASZ126 60x3,5
○ 64 / ks
mat | matt
červená / red / czerwona / красный / piros / rojo



DAK63656
Trend
PEI 4 ○ 82 / m²
mat | matt
béžovo-šedá / beige-grey / beżowo-szary
бежевый-серый / bézs-szürke / beige-gris



20x60
v2



60x60



PEI 5



R9



A



v2



PEI 4



výrobek / product	cm	mm	EN	ks/m ²	m ²	m ²	kg	kg/m ²	brutto kg		
obkládačka / wall tile	20x60	198x598x10	EN 14411:2016, annex L BIII GL	9	8,3	1,08	42	45,36	20,0	18,5	865
inzerťo / insert (set)	20x60	198x598x10	EN 14411:2016, annex L BIII GL	2	8,3	0,72	-	-	13,3	18,5	-
listela / listel	60x3,5	598x35x10	EN 14411:2016, annex L BIII GL	6	47,6	0,13	-	-	2,3	18,5	-
dlaždice / floor tile	60x60	598x598x10	EN 14411:2016, annex G BIIa GL	3	2,8	1,08	32	34,56	24,9	23,0	820



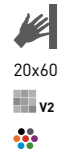

WADVE027
82 / m²
lesk | glossy

světle šedá / light grey / jasnoszara
светло-серый / világosszürke / gris claro



WLASZ028
74 / ks
mat/lesk | matt/glossy

60x4,5



WADVE028
82 / m²
lesk | glossy



WITVE128
74 / ks
mat | matt



WADVE029
82 / m²
lesk | glossy

světle béžová / light beige / jasnobežowa
светло-бежевый / világosbézs / beige claro



WLASZ030
74 / ks
mat/lesk | matt/glossy

60x4,5



WADVE030
82 / m²
lesk | glossy



WITVE130
74 / ks
mat | matt



WDM02228 (SET)
78 / set
mat/lesk | matt/glossy



WDM02230 (SET)
78 / set
mat/lesk | matt/glossy

béžová / beige / bežowa / бежевый / bézs / beige



DAK63655
Trend
PEI 4 82 / m²
mat | matt

tmavě šedá / dark grey / ciemnoszara
темно-серый / sötétszürke / gris oscuro



DAK63654
Trend
PEI 5 82 / m²
mat | matt

šedá / grey / szara / серый / szürke / gris

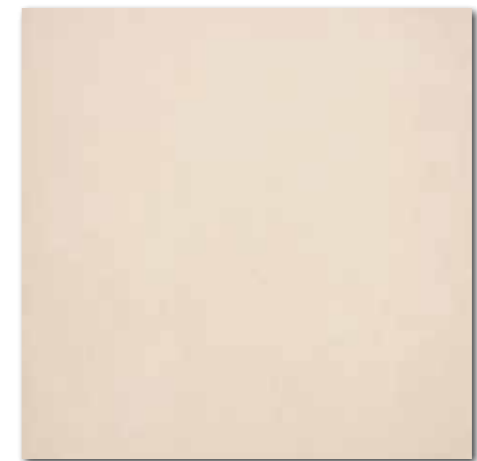

DAK63658
Trend
PEI 5 82 / m²
mat | matt

světle béžová / light beige / jasnobežowa
светло-бежевый / világosbézs / beige claro

výrobek / product



výrobek / product	cm	mm	EN	mm	kg/m ²	mm	m ²	m ²	kg	kg/m ²	brutto kg
obkládačka / wall tile	20x60	198x598x10	EN 14411:2016, annex L BIII GL	9	8,3	1,08	42	45,36	20,0	18,5	865
inzerito / insert	20x60	198x598x10	EN 14411:2016, annex L BIII GL	4	8,3	0,48	-	-	8,9	18,5	-
listela / listel	60x4,5	598x45x10	EN 14411:2016, annex L BIII GL	6	37,1	0,16	-	-	3,0	18,5	-
mozaika set 30x30 cm / mosaic sheet 30x30 cm	2,5x2,5	23x23x10	STO É. 030 - 049913	3	11	0,27	-	-	5,0	18,5	-
dlaždice / floor tile	60x60	598x598x10	EN 14411:2016, annex G BIIa GL	3	2,8	1,08	32	34,56	24,9	23,0	820

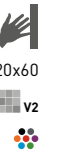



20x60

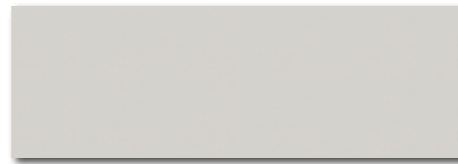

WAAVE012
Concept Plus
80 / m²
lesk | glossy | **V1**

světle šedá / light grey / jasnoszara
светло-серый / világosszürke / gris claro

WAAVE112
Concept
80 / m²
mat | matt | **V1**

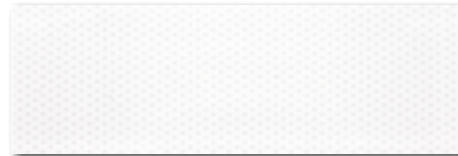

WITVE002
74 / ks
mat/lesk | matt/glossy

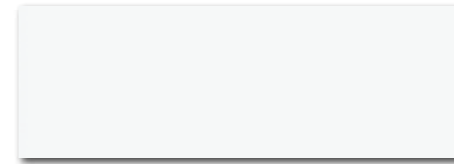

WAAVE000
80 / m²
lesk | glossy | **V1**

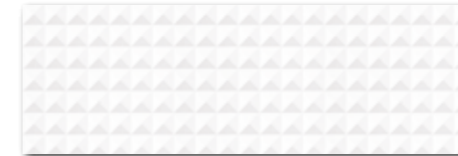

WADVE001
86 / m²
lesk | glossy | **A**
bílá / white / biata / белый / fehér / blanco

WAAVE104
78 / m²
mat | matt | **V1**



WAAVE007
Concept Plus
80 / m²
lesk | glossy | **V1**

světle béžová / light beige / jasnobežowa
светло-бежевый / világosbézs / beige claro

WAAVE107
Concept
80 / m²
mat | matt | **V1**



WITVE001
74 / ks
mat/lesk | matt/glossy



30x30

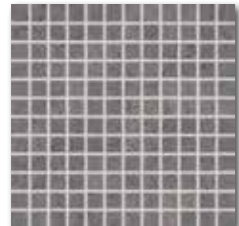

DDM0U611 (SET)
Unistone
PEI 5 82 / set
mat | matt | **V2**

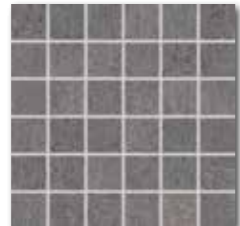

DDM06611 (SET)
Unistone
PEI 5 72 / set
mat | matt | **V2**



DDM0U001 (SET)
Trend
PEI 4 82 / set
mat | matt | **V4** | **A**

vícebarevná / multicoloured / kolorowa
многоцветный / többszínű / multicolor

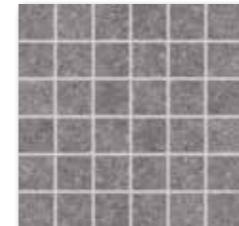

DDM06636 (SET)
Rock
PEI 5 72 / set
mat | matt | **V2**



DDM06717 (SET)
Faro
PEI 4 72 / set
mat | matt | **V4** | **A**



60x60



DAK63611
Unistone
PEI 5 82 / m²
mat | matt | **R9**
šedá / grey / szara / серый / szürke / gris



DAK63656
Trend
PEI 4 82 / m²
mat | matt | **R9** | **A** | **V4** | **A**
béžovo-šedá / beige-grey / bežowo-szary
бежевый-серый / bézs-szürke / beige-gris

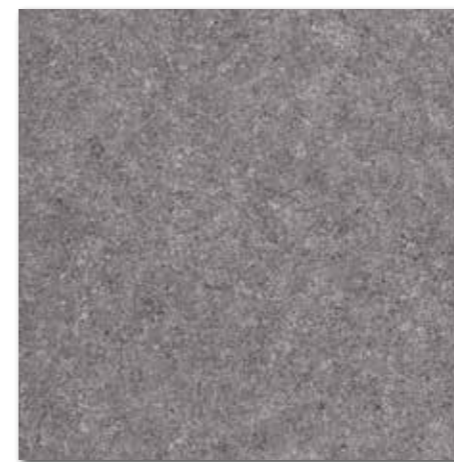

DAK63636
Rock
PEI 5 82 / m²
mat | matt | **R10** | **A** | **V2**
tmavě šedá / dark grey / ciemnoszara
темно-серый / sötétszürke / gris oscuro



DARSU717
Faro
PEI 4 84 / m²
mat | matt | **R9** | **A** | **V4** | **A**
světle hnědá / light brown / jasnobřazowa / светло-коричневый
világosbarna / marrón claro



30x30



60x60
15x60

výrobek / product	cm	mm	EN	ks/m ²	m ²	kg	brutto kg
obkládačka / wall tile	20x60	198x598x10	EN 14411:2016, annex L BIII GL	9	8,3	1,08	42
inzerťo / insert (WITVE...)	20x60	198x598x10	EN 14411:2016, annex L BIII GL	4	8,3	0,48	-
mozaika set 30x30 cm / mosaic sheet 30x30 cm	2,5x2,5	23x23x10	STO č. 030 - 049913	3	11	0,27	-
mozaika set 30x30 cm / mosaic sheet 30x30 cm	5x5	48x48x10	STO č. 030 - 049913	3	11	0,27	-
dlaždice / floor tile	60x60	598x598x10	EN 14411:2016, annex G BIIa GL	3	2,8	1,08	32
dlaždice / floor tile	15x60	148x598x10	EN 14411:2016, annex G BIIa GL	10	11,1	0,90	48



WADY4670
○ 78 / m²
mat | matt



WITV4670
○ 78 / ks
mat | matt



WADY4671
○ 78 / m²
mat | matt



WITV4671
○ 78 / ks
mat | matt

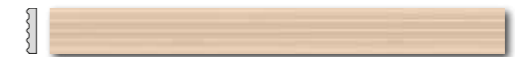

WLASZ671
○ 78 / ks
mat | matt



WDM05670 (SET)
○ 66 / set
mat | matt



WDM05671 (SET)
○ 66 / set
mat | matt

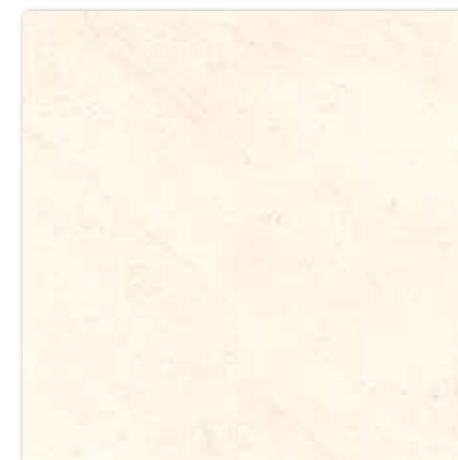

DAK63670
PEI 5 ○ 82 / m²
mat | matt

světle béžová / light beige / jasnebežowa
светло-бежевый / világosbézs / beige claro



DAK63671
PEI 5 ○ 82 / m²
mat | matt

běžová / beige / bežowa / бежевый / bézs / beige

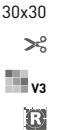

výrobek / product	cm	mm	EN	ks/m ²	m ²	m ²	m ²	kg	kg/m ²	brutto kg	
obkládačka / wall tile	30x60	298x598x10	EN 14411:2016, annex L BIII GL	6	5,56	1,08	40	43,20	20,0	18,5	825
inzerito / insert	30x60	298x598x10	EN 14411:2016, annex L BIII GL	4	5,56	0,72	-	-	13,3	18,5	-
listela / listel	60x6	598x60x10	EN 14411:2016, annex L BIII GL	5	27,8	0,18	-	-	3,3	18,5	-
mozaika set 30x30 cm / mosaic sheet 30x30 cm	5x5	48x48x10	STO č. 030 - 049913	3	11	0,27	-	-	5,0	18,5	-
dlaždice / floor tile	60x60	598x598x10	EN 14411:2016, annex G BIIa GL	3	2,8	1,08	32	34,56	24,9	23,0	820



20x40

20x40



WATMB060
○ 68 / m²
mat | matt | **V2**



WATMB061
○ 68 / m²
mat | matt | **V2**



WATMB062
○ 68 / m²
mat | matt | **V2**

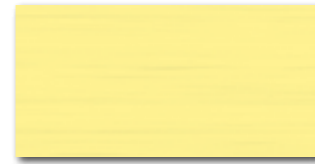

WATMB063
○ 68 / m²
mat | matt | **V2**



WATMB064
○ 68 / m²
mat | matt | **V2**

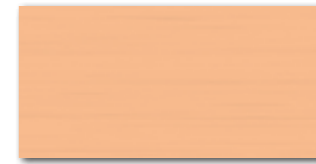

WATMB065
○ 68 / m²
mat | matt | **V2**

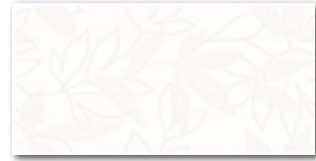

WITMB060
○ 58 / ks
mat | matt

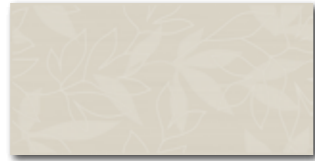

WITMB061
○ 58 / ks
mat | matt

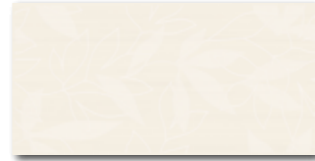

WITMB062
○ 58 / ks
mat | matt



WILMB063 (SET)
○ 58 / set
mat | matt | >=



WILMB064 (SET)
○ 58 / set
mat | matt | >=



WILMB065 (SET)
○ 58 / set
mat | matt | >=



WITMB047
○ 58 / ks
mat/lesk | matt/glossy

40x2

40x2

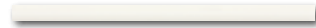

WLRMG060
○ 52 / ks
mat | matt



WLRMG061
○ 52 / ks
mat | matt

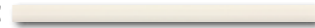

WLRMG062
○ 52 / ks
mat | matt



WLRMG063
○ 52 / ks
mat | matt



WLRMG064
○ 52 / ks
mat | matt



WLRMG065
○ 52 / ks
mat | matt

30x30

>=

R



WDM05060 (SET)
○ 72 / set
mat | matt
bilá / white / biata / белый / fehér / blanco

45x45

R9

A

V2

R

R

R

R

R

R

R

R

R

R

R

R

R

R

R

R

R

R

R

R



DAK44653
Trend
PEI 5 ○ 74 / m²
mat | matt
světle šedá / light grey / jasnoszara
светло-серый / világosszürke / gris claro

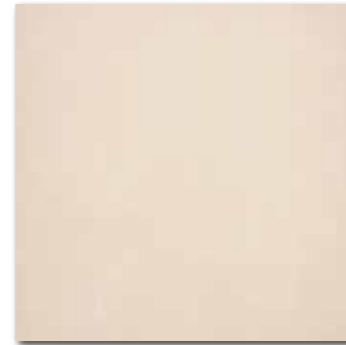

DAK44658
Trend
PEI 5 ○ 74 / m²
mat | matt
světle béžová / light beige / jasnobežowa
светло-бежевый / világosbézs / beige claro

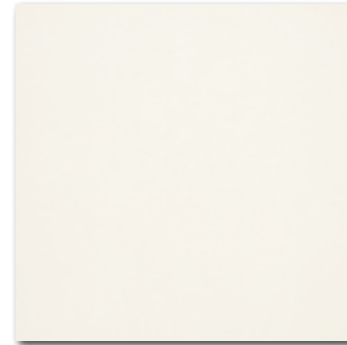

DAK44652
Trend
PEI 5 ○ 74 / m²
mat | matt
slonová kost / ivory / kość stoniowa
слоновая кость / elefántcsont / marfil



DAK44654
Trend
PEI 5 ○ 74 / m²
mat | matt
šedá / grey / szara / серый / szürke / gris

výrobek / product	cm	mm	EN	ks/m ²	m ²	kg	kg/m ²	brutto kg
obkládačka / wall tile	20x40	198x398x7	EN 14411:2016, annex L BIII GL	20	12,5	1,60	48	76,80
inzerťo / insert	20x40	198x398x7	EN 14411:2016, annex L BIII GL	4	12,5	0,32	-	4,1
reliéfní listela / relief listel	40x2	398x20x7	STO č. 030 - 054498	12	125	0,10	-	1,2
mozaika set 30x30 cm / mosaic sheet 30x30 cm	5x5	48x48x7	STO č. 030 - 049913	3	11	0,27	-	3,5
dlaždice / floor tile	45x45	445x445x10	EN 14411:2016, annex G BIIa GL	6	5	1,21	26	31,46

45x45

R9

A

V2

R

R

R

R

R

R

R

R

R

R

R

R

R

R

R

R

R

R

R

R



20x40
v2



WADMB124
82 / m²
lesk | glossy



WADMB125
82 / m²
lesk | glossy



WADMB224
82 / m²
lesk | glossy



WADMB225
82 / m²
lesk | glossy

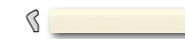

WLRDH124
42 / ks
lesk | glossy

slonová kost / ivory / kość słoniowa
слоновая кость / elefántcsont / marfil



WLRDH125
42 / ks
lesk | glossy

červená / red / czerwona / красный / piros / rojo

20x3



DAR44663
Siena
PEI 5 78 / m²
mat | matt

světle béžová / light beige / jasnobeżowa / светло-бежевый
világosbézs / beige claro



DARPP663
Siena
PEI 5 82 / m²
mat | matt



DAR2W663
Siena
PEI 5 82 / m²
mat | matt



45x45
22,5x45
22,5x22,5



R9



V3

výrobek / product



EN



výrobek / product	cm	mm	EN	mm	ks/m ²	m ²	m ²	m ²	kg	kg/m ²	brutto kg
obkládačka / wall tile	20x40	198x398x7	EN 14411-2016, annex L BIII GL	18	12,5	1,44	48	69,12	20,4	14,2	1 007
reliéfní listela / relief listel	20x3	198x30	STO č. 030 - 054498	18	1,67	0,11	-	-	1,7	15,8	-
dlaždice / floor tile	45x45	445x445x10	EN 14411-2016, annex G BIa GL	6	5	1,21	26	31,46	25,0	20,7	677
dlaždice / floor tile	22,5x45	221x445x10	EN 14411-2016, annex G BIa GL	11	9,9	1,11	48	53,28	22,9	20,7	1 103
dlaždice / floor tile	22,5x22,5	221x221x10	EN 14411-2016, annex G BIa GL	24	19,8	1,22	45	54,90	25,2	20,7	658

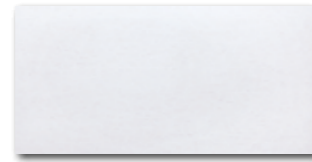

WATMB609
○ 70 / m²
mat | matt



WATMB610
○ 70 / m²
mat | matt



WATMB612
○ 70 / m²
mat | matt



WATMB611
○ 70 / m²
mat | matt



WATMB613
○ 70 / m²
mat | matt

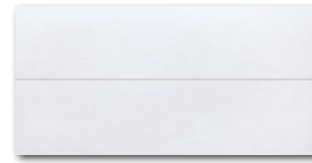

WIFMB609
○ 52 / ks
mat | matt



WIFMB610
○ 52 / ks
mat | matt



WIFMB612
○ 52 / ks
mat | matt



WIFMB611
○ 52 / ks
mat | matt

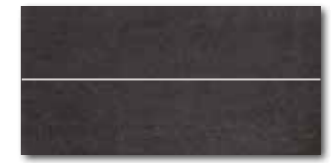

WIFMB613
○ 52 / ks
mat | matt



WITMB046
○ 64 / ks
mat | matt



WITMB045
○ 64 / ks
mat | matt



WLAMG609
○ 52 / ks
mat | matt



WLAMG610
○ 52 / ks
mat | matt



WLAMG612
○ 52 / ks
mat | matt



WLAMG611
○ 52 / ks
mat | matt



WLAMG613
○ 52 / ks
mat | matt



DAA3B609
PEI 5 ○ 70 / m²
mat | matt

bílá / white / biata / белый
fehér / blanco



DAA3B610
PEI 5 ○ 70 / m²
mat | matt

béžová / beige / bežowa / бежевый
bézs / beige



DAA3B612
PEI 5 ○ 70 / m²
mat | matt

šedohnědá / grey-brown / szarobrazowa
серо-коричневый / barna-szürke / gris-marrón



DAA3B611
PEI 5 ○ 70 / m²
mat | matt

šedá / grey / szara / серый / szürke / gris



DAA3B613
PEI 5 ○ 70 / m²
mat | matt

černá / black / czarna / черный
fekete / negro



20x40
v2

40x2



33x33



R9



v2

výrobek / product



EN



obkladáčka / wall tile	20x40	198x398x7	EN 14411-2016, annex L BIII GL	20	12,5	1,60	48	76,80	20,6	12,9	1 016
inzerito / insert	20x40	198x398x7	EN 14411-2016, annex L BIII GL	4	12,5	0,32	-	-	4,1	12,9	-
listela / listel	40x2	398x20x7	EN 14411-2016, annex L BIII GL	6	113,6	0,05	-	-	0,9	17,1	-
dlaždice / floor tile	33x33	333x333x8	EN 14411-2016, annex G BIIa GL	12	9	1,33	44	58,52	23,6	17,7	1 061

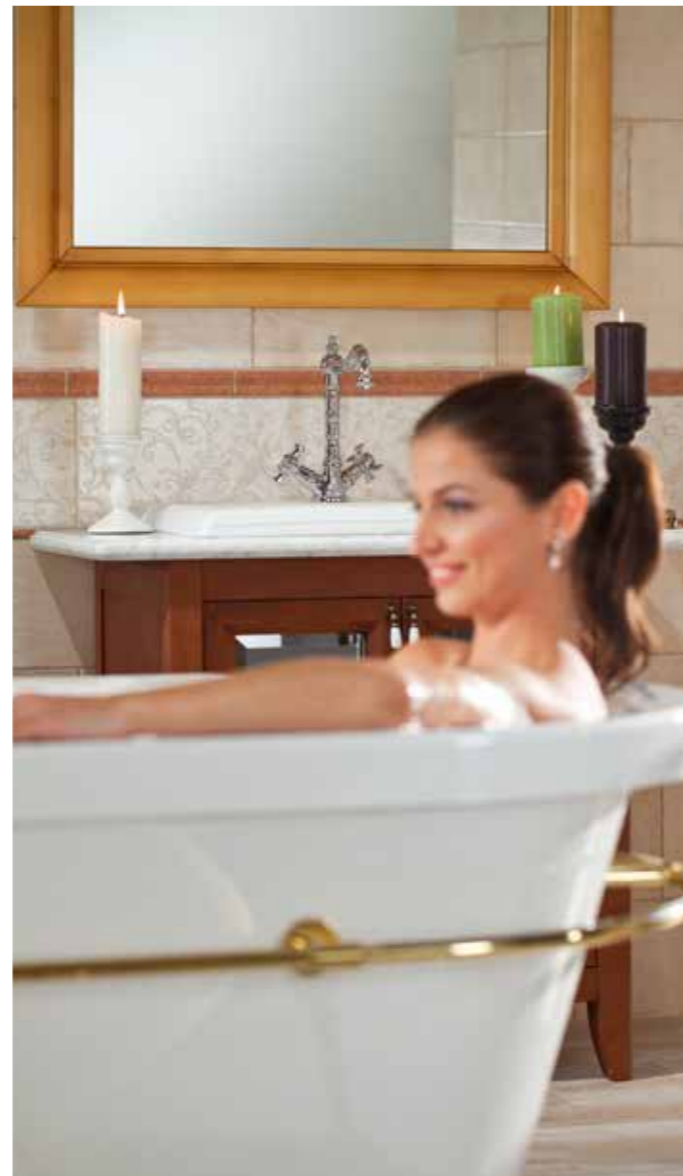

serie manufactura



serie manufactura



20x40
v3



WADMB013
○ 76 / m²
mat | matt



WADMB014
○ 76 / m²
mat | matt

šedomodrá / grey-blue / szaro-niebieska
серо-голубой / szürke-kék / azul-gris



WADMB015
○ 76 / m²
mat | matt



WADMB010
○ 76 / m²
mat | matt



WADMB011
○ 76 / m²
mat | matt



WADMB012
○ 76 / m²
mat | matt

20x40
40x3,5
40x4
40x1,5



WITMB041
○ 64 / ks
mat/lesk | matt/glossy



WLAMH019
○ 50 / ks
mat/lesk | matt/glossy



WLRMH015
○ 68 / ks
mat | matt



WLRMJ015
○ 52 / ks
mat | matt



WITMB040
○ 64 / ks
mat/lesk | matt/glossy



WLAMH018
○ 50 / ks
mat/lesk | matt/glossy



WLRMH012
○ 68 / ks
mat | matt



WLRMJ012
○ 52 / ks
mat | matt

20x40
v3

20x40
40x3,5
40x4
40x1,5

30x30
v3

30x30
v3



WDM05013 (SET)
○ 66 / set
mat | matt

světle šedá / light grey / jasnoszara
светло-серый / világosszürke / gris claro



WDM05015 (SET)
○ 66 / set
mat | matt

zelená / green / zielona
зеленый / zöld / verde



WDM05014 (SET)
○ 66 / set
mat | matt

světle béžová / light beige
jasnobežowa / светло-бежевый
világosbézs / beige claro

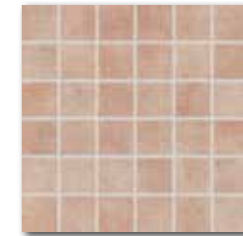

WDM05012 (SET)
○ 66 / set
mat | matt

cihlová / brick / ceglata
кирпичный / téгла / ladrillo

15x60
R9
V4



DARSU719
Faro
PEI 5 ○ 84 / m²
mat | matt

šedo-bílá / grey-white / szaro-biata
серый и белый / szürke és fehér / blanco-gri



DARSU716
Faro
PEI 4 ○ 84 / m²
mat | matt

běžová / beige / bežowa / бежевый / bézs / beige



DARSU717
Faro
PEI 4 ○ 84 / m²
mat | matt

světle hnědá / light brown / jasnobražowa / светло-коричневый
világosbarna / marrón claro

15x60
R9
V4

výrobek / product	cm	mm	EN	ks/m ²	m ²	kg	brutto kg
obkládačka / wall tile	20x40	198x398x7	EN 14411:2016, annex L BIII GL	20	12,5	1,60	76,80
inzerťo / insert	20x40	198x398x7	EN 14411:2016, annex L BIII GL	4	12,5	0,32	-
reliefní listela / relief listel	4x40	40x398	STO č. 030 - 054498	4	62,5	0,06	-
reliefní listela / relief listel	40x1,5	398x15	STO č. 030 - 054498	24	166,7	0,14	-
listela / listel	40x3,5	398x35x7	EN 14411:2016, annex L BIII GL	12	71,4	0,17	-
mozaika set 30x30 cm / mosaic sheet 30x30 cm	5x5	48x48x7	STO č. 030 - 049913	3	11	0,27	-
dlaždice / floor tile	15x60	148x598x10	EN 14411:2016, annex G BIIa GL	10	11,1	0,90	43,20

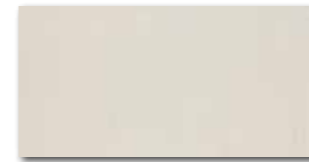

WADMB101
○ 70 / m²
mat | matt



WADMB102
○ 70 / m²
mat | matt



WADMB103
○ 70 / m²
mat | matt



WADMB111
○ 74 / m²
mat | matt



WADMB112
○ 74 / m²
mat | matt



WADMB113
○ 74 / m²
mat | matt



WLAMG001
○ 52 / ks
lesk | glossy



WLAMG002
○ 52 / ks
lesk | glossy



WLAMG003
○ 52 / ks
lesk | glossy

hnědá / brown / brązowa / коричневый
barna / marrón



WITMB037
○ 68 / ks
mat | matt



WLAMH020
○ 56 / ks
mat | matt

fialová / violet / fioletowa / сиреневый
lila / púrpura



WDM05101 (SET)
○ 66 / set
mat | matt
slonová kost / ivory / kość stoniowa
слоновая кость / elefántcsont / marfil



WDM05102 (SET)
○ 66 / set
mat | matt
běžová / beige
beżowa / бежевый / bézs / beige



WDM05103 (SET)
○ 66 / set
mat | matt
hnědá / brown / brązowa
коричневый / barna / marrón



DAA44600
Concept
PEI 4 ○ 76 / m²
mat | matt
běžová / beige / beżowa / бежевый / bézs / beige



DAA3B600
Concept
PEI 4 ○ 76 / m²
mat | matt



výrobek / product	cm	mm	EN	ks/m ²	m ²	m ²	m ²	kg	kg/m ²	brutto kg	
obkládačka / wall tile (WADMB...)	20x40	198x398x7	EN 14411:2016, annex L BIII GL	20	12,5	1,60	48	76,80	20,6	12,9	1 016
listela / listel	40x2,2	398x22x7	EN 14411:2016, annex L BIII GL	6	113,6	0,05	-	-	1,0	17,1	-
inzerto / insert	20x40	198x398x7	EN 14411:2016, annex L BIII GL	4	12,5	0,32	-	-	4,1	12,9	-
listela / listel	40x3,5	398x35x7	EN 14411:2016, annex L BIII GL	12	71,4	0,17	-	-	2,4	14,4	-
mozaika set 30x30 cm / mosaic sheet 30x30 cm	5x5	48x48x7	STO č. 030 - 049913	3	11	0,27	-	-	3,5	12,9	-
dlaždice / floor tile	45x45	448x448x10	EN 14411:2016, annex G BIIa GL	6	5	1,21	26	31,46	25,0	20,7	677
dlaždice / floor tile	33x33	333x333x8	EN 14411:2016, annex G BIIa GL	12	9	1,33	44	58,52	23,6	17,7	1 061

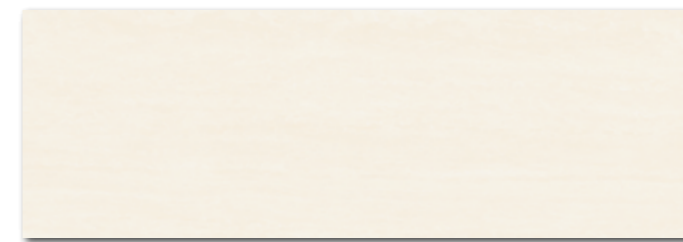

WADV5001
○ 86 / m²
mat | matt

světle béžová / light beige / jasnobežowa
светло-бежевый / világosbézs / beige claro



WADV5002
○ 86 / m²
mat | matt

béžová / beige / bežowa
бежевый / bézs / beige



WADKB001
○ 68 / m²
mat | matt | **V2**



WADKB002
○ 78 / m²
mat | matt | **V2**



WADKB004
○ 78 / m²
mat | matt | **V4**

vícebarevná / multicoloured
kolorowa / многоцветный
többszínű / multicolor



WITKB054
○ 58 / ks
mat | matt



WLAK1022
○ 42 / ks
mat | matt



WLAK1023
○ 42 / ks
mat | matt



WLAGC022
○ 38 / ks
mat | matt

světle béžová / light beige / jasnobežowa
светло-бежевый / világosbézs / beige claro



WLAGC023
○ 38 / ks
mat | matt



DAR35030
Travertin
PEI 5 ○ 72 / m²
mat | matt

slonová kost / ivory / kość słoniowa / слонобая
кость / elefántcsont / marfil



DAR35035
Travertin
PEI 5 ○ 72 / m²
mat | matt

béžová / beige / bežowa
бежевый / bézs / beige



DAR35034
Travertin
PEI 5 ○ 72 / m²
mat | matt

okrová / ochre
ochrowa / oxpa / okker / ocree

výrobek / product	mm H	mm W	EN	ks/m ²	m ²	kg	brutto kg				
obkládačka / wall tile	30x90	298x898x10,5	EN 14411:2016, annex L BIII GL	4	3,7	1,08	30	32,40	21,7	20,1	677
obkládačka / wall tile (WADKB...)	25x33	250x330x7	EN 14411:2016, annex L BIII GL	18	12	1,50	54	81,00	18,6	12,4	1 030
inzerťo / insert	25x33	250x330x7	EN 14411:2016, annex L BIII GL	4	12	0,33	-	-	4,1	12,4	-
listela / listel	33x3,2	330x32x7	EN 14411:2016, annex L BIII GL	12	94,7	0,12	-	-	1,5	14,2	-
listela / listel	25x3,2	250x32x7	EN 14411:2016, annex L BIII GL	14	125	0,11	-	-	1,4	12,8	-
dlaždice / floor tile	30x30	298x298x8	EN 14411:2016, annex G BIIa GL	13	11	1,18	48	56,64	21,0	17,8	1 034



news



25x33 / 3,2x33

25x3,2



30x30

R10

A

v3

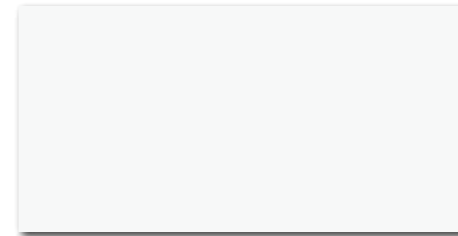

WAKV4000
84 / m²
lesk | glossy



WITV4003
96 / set
lesk | glossy



(SET)



DAR6368
Clay
PEI 5 86 / m²
mat | matt
bílá / white / biata / белый / fehér / blanco

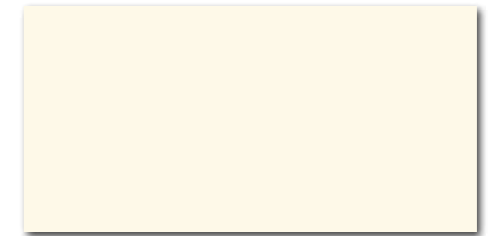

WAKV4007
84 / m²
lesk | glossy

světle béžová / light beige / jasno-bežová / светло-бежевый
világosbézs / beige claro



WLASU001
88 / ks
mat | matt



WLASZ001
68 / ks
lesk | glossy

vícebarevná / multicoloured / kolorowa / многоцветный
többszínű / multicolor

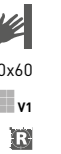

30x60

V1

R9

30x60
60x15
60x5,5

R9



60x60

R9

V2

R9

výrobek / product



EN



výrobek / product	cm	mm	EN	ks/m ²	m ²	m ³	kg	kg/m ²	brutto kg		
obkládačka / wall tile	30x60	298x598x10	EN 14411:2016, annex L BIII GL	6	5,56	1,08	40	43,20	20,0	18,5	825
inserto / insert (set)	30x60	298x598x10,5	EN 14411:2016, annex L BIII GL	2	5,56	0,72	-	-	14,5	20,1	-
listela / listel	60x15	598x148x10,5	EN 14411:2016, annex L BIII GL	6	11,3	0,54	-	-	7,4	13,9	-
listela / listel	60x5,5	598x55x10,5	EN 14411:2016, annex L BIII GL	6	30,3	0,20	-	-	4,0	20,1	-
dlaždice / floor tile	60x60	598x598x10	EN 14411:2016, annex G BIIa GL	3	2,8	1,08	32	34,56	24,9	23,0	820



WATP3024
○ 76 / m²
mat/lesk | matt/glossy



WITP3019 (SET)
○ 82 / set
mat/lesk | matt/glossy
bílá / white / biata / белый / fehér / blanco



WLAPJ005
○ 58 / ks
lesk | glossy
běžová / beige / bežowa / бежевый / bézs / beige



WDM05024 (SET)
○ 66 / set
mat/lesk | matt/glossy

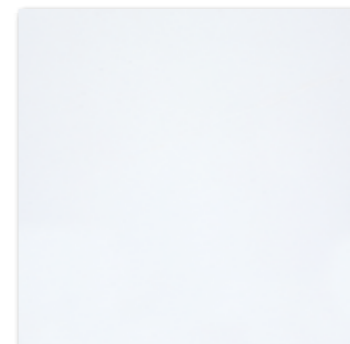

DAK44272
Sandstone Plus
PEI 5 ○ 78 / m²
mat | matt
slonová kost / ivory / košć stoniowa
слоновая кость / elefántcsont / marfil



WATP3025
○ 76 / m²
mat/lesk | matt/glossy



WLAPP001 (SET)
○ 84 / set
mat/lesk | matt/glossy
hnědá / brown / brązowa / коричневый / barna / marrón



WLAPJ004
○ 58 / ks
lesk | glossy
červená / red / czerwona / красный / piros / rojo

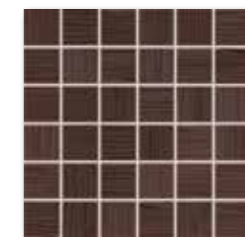

WDM05025 (SET)
○ 66 / set
mat/lesk | matt/glossy



DAK44274
Sandstone Plus
PEI 5 ○ 78 / m²
mat | matt
hnědá / brown / brązowa / коричневый / barna / marrón



25x45 / 45x5,7

45x4,8

30x30



45x45



R9



v3



R

výrobek / product	mm H	mm W	EN	ks/m ²	m ²	m ³	kg	kg/m ²	brutto kg		
obkládačka / wall tile	25x45	250x450x8	EN 14411:2016, annex L BIII GL	13	9	1,50	51	76,50	20,7	13,8	1 081
inzerťo / insert (set)	25x45	250x450x8	EN 14411:2016, annex L BIII GL	2	9	0,45	-	-	7,3	16,2	-
listela / listel (set)	45x5,7	450x57x8	EN 14411:2016, annex L BIII GL	4	38,9	0,41	-	-	7,2	17,6	-
listela / listel	45x4,8	450x48x8	EN 14411:2016, annex L BIII GL	6	46,3	0,13	-	-	1,8	13,9	-
mozaika set 30x30 cm / mosaic sheet 30x30 cm	5x5	48x48x8	STO č. 030 - 049913	3	11	0,27	-	-	3,7	13,8	-
dlaždice / floor tile	45x45	445x445x10	EN 14411:2016, annex G BIIa GL	6	5	1,21	26	31,46	25,0	20,7	677

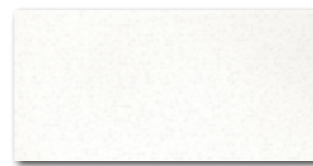

WATMB040
○ 72 / m²
mat/lesk | matt/glossy
bílá / white / biata / белый / fehér / blanco



WATMB044
○ 72 / m²
mat/lesk | matt/glossy
světle šedomodrá / light grey-blue
jasnoszaro-niebieska / светло-серо-голубой
világosszürke-kék / luz gris-azul



WATMB042
○ 72 / m²
mat/lesk | matt/glossy
fialová / violet / fioletova
sиреневый / lila / púrpura



WATMB045
○ 72 / m²
mat/lesk | matt/glossy
tmavě modrá / dark blue / ciemnoniebieska
синий / sötétkék / azul oscuro



WATMB041
○ 72 / m²
mat/lesk | matt/glossy
světle žlutá / light yellow / jasnozółta
светло-желтый / világossárga
amarillo claro



WATMB043
○ 72 / m²
mat/lesk | matt/glossy
zelená / green / zielona / зеленый / zöld / verde



WATMB046
○ 72 / m²
mat/lesk | matt/glossy
šedohnědá / grey-brown / szarobrązowa
серо-коричневый / barna-szürke / gris-marrón



WLRMG041
○ 52 / ks
lesk | glossy
světle žlutá / light yellow / jasnozółta
светло-желтый / világossárga
amarillo claro



WLRMG043
○ 52 / ks
lesk | glossy
zelená / green / zielona / зеленый / zöld / verde



WLRMG046
○ 52 / ks
lesk | glossy
šedohnědá / grey-brown / szarobrązowa
серо-коричневый / barna-szürke / gris-marrón



WLRMG044
○ 52 / ks
lesk | glossy
světle šedomodrá / light grey-blue
jasnoszaro-niebieska / светло-серо-голубой
világosszürke-kék / luz gris-azul



WLRMG042
○ 52 / ks
lesk | glossy
fialová / violet / fioletova
sиреневый / lila / púrpura



WLRMG045
○ 52 / ks
lesk | glossy
tmavě modrá / dark blue / ciemnoniebieska
синий / sötétkék / azul oscuro



WLAMH015
○ 46 / ks
mat/lesk | matt/glossy
fialová / violet / fioletova
sиреневый / lila / púrpura

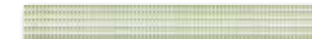

WLAMH014
○ 46 / ks
mat/lesk | matt/glossy
zelená / green / zielona / зеленый / zöld / verde

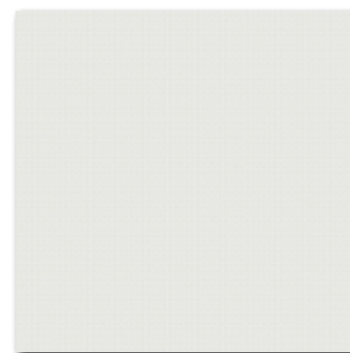

DAA44122
Sidney
PEI 5 ○ 74 / m²
mat/lesk | matt/glossy
bílá / white / biata / белый / fehér / negro

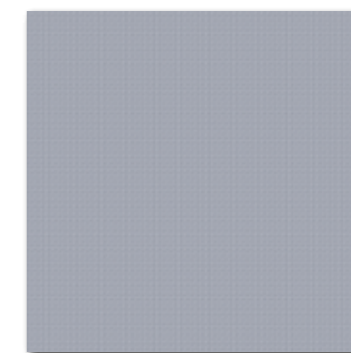

DAA44125
Sidney
PEI 4 ○ 74 / m²
mat/lesk | matt/glossy
šedá / grey / szara / серый / szürke / gris



20x40
v2

40x2

40x4,5



45x45
R9



výrobek / product	cm	mm	EN	ks/m ²	m ²	m ²	kg	kg/m ²	brutto kg		
obkladáčka / wall tile	20x40	198x398x7	EN 14411:2016, annex L BIII GL	20	12,5	1,60	48	76,80	20,6	12,9	1 016
reliefní listela / relief listel	40x2	398x20	STO E. 030 - 054498	12	125	0,10	-	-	1,8	18,8	-
listela / listel	40x4,5	398x45x7	EN 14411:2016, annex L BIII GL	12	55,5	0,22	-	-	2,8	12,8	-
dlaždice / floor tile	45x45	448x448x10	EN 14411:2016, annex G BIa GL	6	5	1,21	26	31,46	25,0	20,7	677

serie
concept plus



serie
concept plus





30x60
30x90

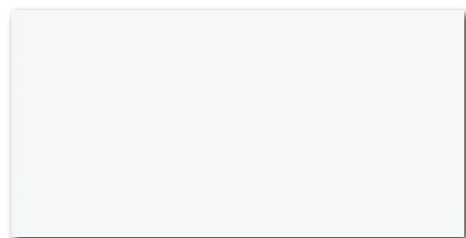

WAKV4000
○ 84 / m²
lesk | glossy | ■ V1

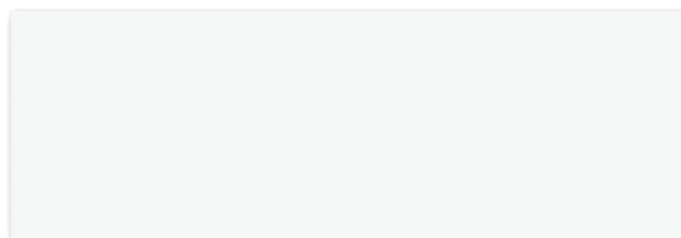

WAKV5000
○ 88 / m²
lesk | glossy | ■ V1



WR2V4000
○ 86 / m²
lesk | glossy | ■ V2

bílá / white / biata / белый / fehér / blanco

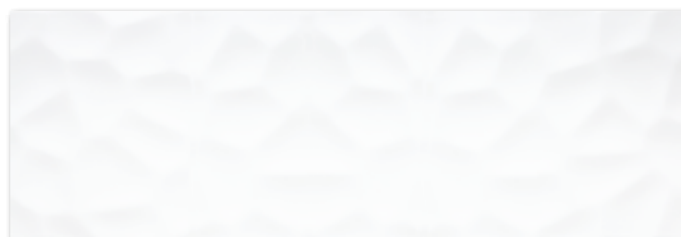

WR2V5000
○ 92 / m²
lesk | glossy | ■ V2

news

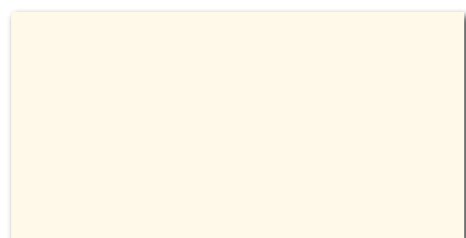

WAKV4007
○ 84 / m²
lesk | glossy | ■ V1

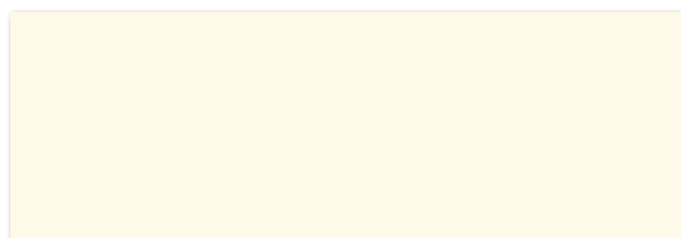

WAKV5007
○ 88 / m²
lesk | glossy | ■ V1

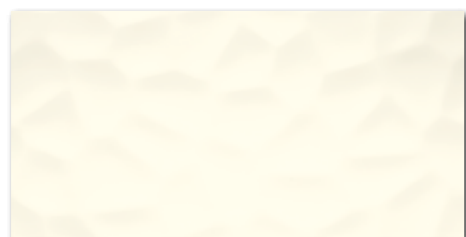

WR2V4007
○ 86 / m²
lesk | glossy | ■ V2

světle béžová / light beige / jasnobežowa / светло-бежевый / világosbézs / beige claro



WAKV4012
○ 84 / m²
lesk | glossy | ■ V1



WAKV5012
○ 88 / m²
lesk | glossy | ■ V1



WR2V4012
○ 86 / m²
lesk | glossy | ■ V2

světle šedá / light grey / jasnoszara / светло-серый / világosszürke / gris claro



WAKV4008
○ 84 / m²
lesk | glossy | ■ V1

běžová / beige / bežowa / бежевый / bézs / beige



WAKV5008
○ 88 / m²
lesk | glossy | ■ V1



WAKV4010
○ 84 / m²
lesk | glossy | ■ V1

šedá / grey / szara / серый / szürke / gris



WAKV5010
○ 88 / m²
lesk | glossy | ■ V1

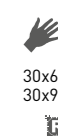

30x60
30x90

výrobek / product



EN



obkládačka / wall tile
obkládačka / wall tile

30x60

30x90

298x598x10

298x898x10,5

EN 14411:2016, annex L BIII GL

EN 14411:2016, annex L BIII GL

6

4

5,56

3,7

1,08

1,08

40

30

43,20

32,40

20,0

21,7

18,5

20,1

825

677

serie concept plus

serie concept plus

30x60
20x60
v1

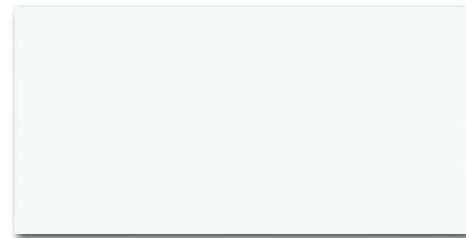

WAAV4000
○ 78 / m²
lesk | glossy
bílá / white / biata / белый / fehér / blanco

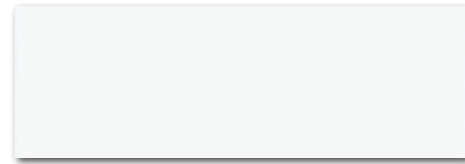

WAAVE000
○ 78 / m²
lesk | glossy

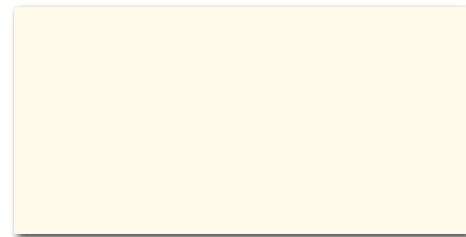

WAAV4007
○ 80 / m²
lesk | glossy
světle béžová / light beige
jasnobéžová / светло-бежевый / világosbézs / beige claro

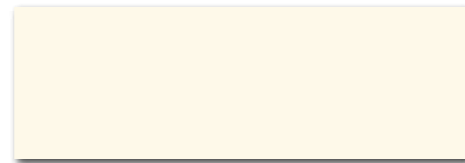

WAAVE007
○ 80 / m²
lesk | glossy

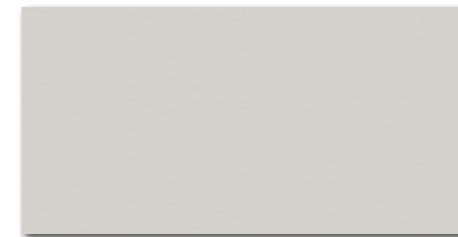

WAAV4012
○ 80 / m²
lesk | glossy
světle šedá / light grey / jasnoszara / светло-серый
világosszürke / gris claro

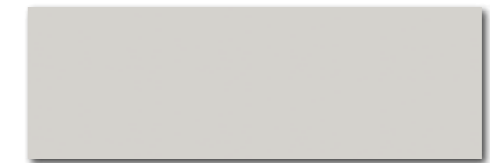

WAAVE012
○ 80 / m²
lesk | glossy

30x60
15x60
v1

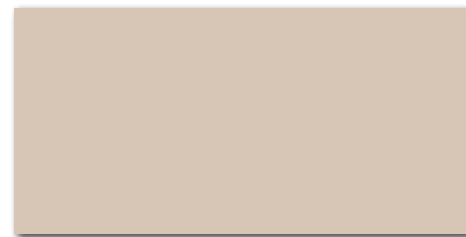

WAAV4008
○ 80 / m²
lesk | glossy
béžová / beige / beżowa / бежевый / bézs / beige

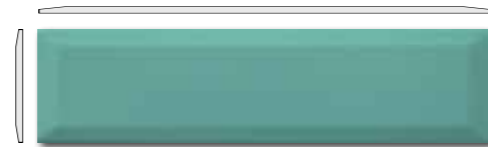

WARSU467
○ 58 / ks
mat | matt
tyrkysová / turquoise
turkusowa / цвет морской волны / türkiz / turquesa

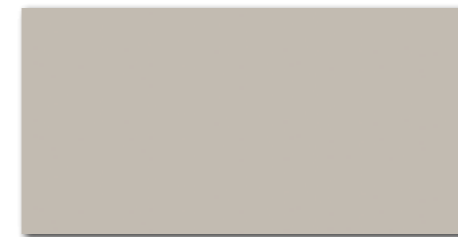

WAAV4010
○ 80 / m²
lesk | glossy
šedá / grey / szara / серый / szürke / gris



WARSU464
○ 58 / ks
mat | matt
žlutozelená / yellow-green / zółto-zielony
жело-зеленый / sárga-zöld / verde y oro

45x45
R9
v2

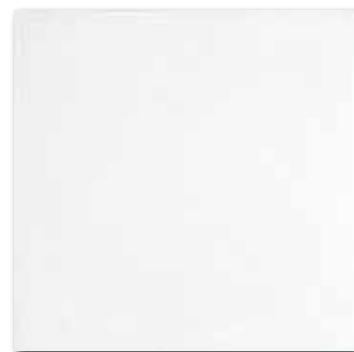

DAA44599
Concept
PEI 4 ○ 76 / m²
mat | matt
bílá / white / biata / белый / fehér / blanco



DAA44600
Concept
PEI 4 ○ 76 / m²
mat | matt
béžová / beige / beżowa / бежевый / bézs / beige



DAA44601
Concept
PEI 3 ○ 76 / m²
mat | matt
hnědá / brown / brązowa / коричневый
barna / marrón



DAA44602
Concept
PEI 4 ○ 76 / m²
mat | matt
šedá / grey / szara / серый / szürke / gris



DAA44603
Concept
PEI 3 ○ 76 / m²
mat | matt
černá / black / czarna / черный / fekete / negro

30x60
20x60
v1

30x60
20x60
v1

30x60
15x60
v1

45x45
R9
v2

výrobek / product	cm	mm	EN	ks/m ²	m ²	m ²	kg/m ²	brutto kg
obkládačka / wall tile	30x60	298x598x10	EN 14411:2016, annex L BIII GL	6	5,56	1,08	40	43,20
obkládačka / wall tile	20x60	198x598x10	EN 14411:2016, annex L BIII GL	9	8,3	1,08	42	45,36
inzerťo / insert	15x60	148x598x10	EN 14411:2016, annex L BIII GL	8	11,1	0,72	-	13,3
dlaždice / floor tile	45x45	448x448x10	EN 14411:2016, annex G Bla GL	6	5	1,21	26	31,46

serie concept plus

serie concept plus

20x40
v1

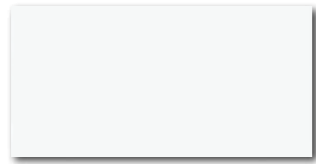

WAAMB000
74 / m²
lesk | glossy

bílá / white / biata / белый / fehér / blanco



WAAMB007
74 / m²
lesk | glossy



WAAMB008
74 / m²
lesk | glossy



WAAMB009
74 / m²
lesk | glossy

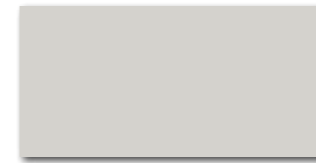

WAAMB012
74 / m²
lesk | glossy



WAAMB010
74 / m²
lesk | glossy



WAAMB011
74 / m²
lesk | glossy



WIFMB007
52 / ks
lesk | glossy

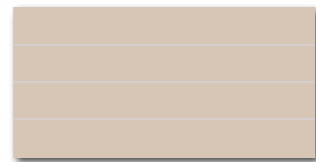

WIFMB008
52 / ks
lesk | glossy

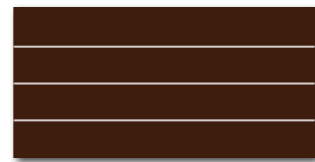

WIFMB009
52 / ks
lesk | glossy

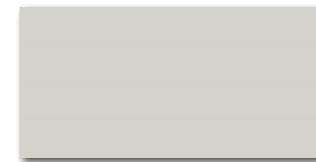

WIFMB012
52 / ks
lesk | glossy

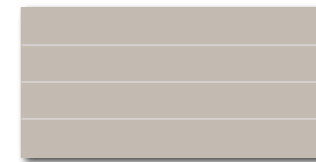

WIFMB010
52 / ks
lesk | glossy



WIFMB011
52 / ks
lesk | glossy

20x6



WARDT107
28 / ks
mat | matt

světle béžová / light beige
jasnobéžová / светло-бежевый
világosbézs / beige claro



WARDT108
28 / ks
mat | matt

béžová / beige / bežowa
бежевый / bézs / beige



WARDT109
28 / ks
mat | matt

hnědá / brown / brązowa
коричневый / barna / marrón



WARDT112
28 / ks
mat | matt

světle šedá / light grey / jasnoszara
светло-серый / világosszürke / gris claro



WARDT110
28 / ks
mat | matt

šedá / grey / szara
серый / szürke / gris

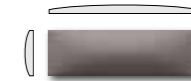

WARDT111
28 / ks
mat | matt

tmavě šedá / dark grey
ciemnoszara / темно-серый
sötétszürke / gris oscuro



WARDT104
28 / ks
mat | matt



WARDT001
28 / ks
lesk | glossy

oranžová / orange / pomarańczowa
оранжевый / narancs / naranja



WARDT002
28 / ks
lesk | glossy

červená / red / czerwona
красный / piros / rojo

45x45

R9
v2

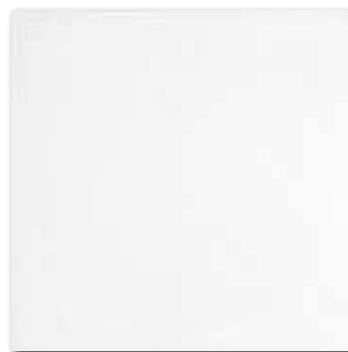

DAA44599
Concept
PEI 4 76 / m²
mat | matt

bílá / white / biata / белый / fehér / blanco



DAA44600
Concept
PEI 3 76 / m²
mat | matt

béžová / beige / bežowa / бежевый
bézs / beige



DAA44601
Concept
PEI 3 76 / m²
mat | matt

hnědá / brown / brązowa / коричневый
barna / marrón



DAA44602
Concept
PEI 4 76 / m²
mat | matt

šedá / grey / szara / серый / szürke / gris



DAA44603
Concept
PEI 3 76 / m²
mat | matt

černá / black / czarna / черный / fekete / negro

výrobek / product

cm	mm	EN	ks/m ²	m ²	kg/m ²	brutto kg
----	----	----	-------------------	----------------	-------------------	-----------

obkládačka / wall tile	20x40	198x398x7	EN 14411:2016, annex L BIII GL	20	12,5	1,60	48	76,80	20,6	12,9	1 016
inzerťo / insert	20x40	198x398x7	EN 14411:2016, annex L BIII GL	4	12,5	0,32	-	-	4,1	12,9	-
inzerťo / insert	20x6	198x60x7	EN 14411:2016, annex L BIII GL	18	83,3	0,22	-	-	2,8	12,9	-
dlaždice / floor tile	45x45	448x448x10	EN 14411:2016, annex G BIIa GL	6	5	1,21	26	31,46	25,0	20,7	677

20x40
v1

20x6

45x45
R9
v2

serie concept plus

serie concept plus



25x33
v1

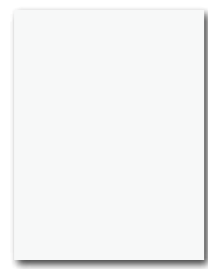

WAAKB000
72 / m²
lesk | glossy

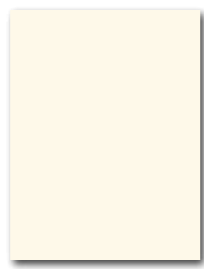

WAAKB007
74 / m²
lesk | glossy



WAAKB008
74 / m²
lesk | glossy

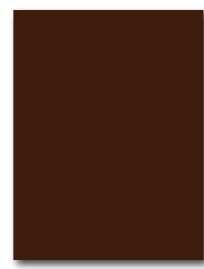

WAAKB009
74 / m²
lesk | glossy



WAAKB012
74 / m²
lesk | glossy



WAAKB010
74 / m²
lesk | glossy



WAAKB011
74 / m²
lesk | glossy

25x10

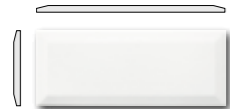

WARGT104
32 / ks
mat | matt

bílá / white / biata / белый
fehér / blanco

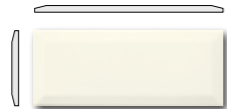

WARGT107
32 / ks
mat | matt

světle béžová / light beige
jasnobežová / светло-бежевый
világosbézs / beige claro

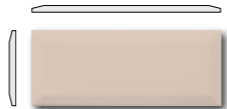

WARGT108
32 / ks
mat | matt

béžová / beige / bežowa
бежевый / bézs / beige

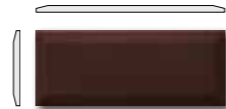

WARGT109
32 / ks
mat | matt

hnědá / brown / brązowa
коричневый / barna / marrón

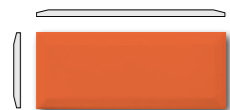

WARGT001
32 / ks
lesk | glossy

oranžová / orange / pomarańczowa
оранжевый / narancs / naranja

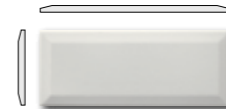

WARGT112
32 / ks
mat | matt

světle šedá / light grey
jasnoszara / светло-серый
világosszürke / gris claro



WARGT110
32 / ks
mat | matt

šedá / grey / szara
серый / szürke / gris



WARGT111
32 / ks
mat | matt

tmavě šedá / dark grey / ciemnoszara
темно-серый / sötétszürke / gris oscuro

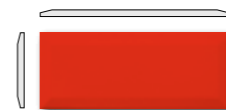

WARGT002
32 / ks
lesk | glossy

červená / red / czerwona
красный / piros / rojo

30x30

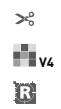

v4

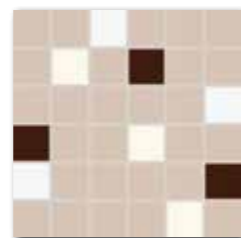

WDM05008 (SET)
66 / set
lesk | glossy

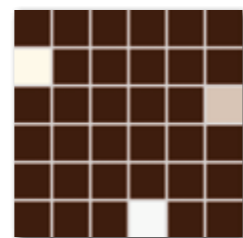

WDM05009 (SET)
66 / set
lesk | glossy



WDM05010 (SET)
66 / set
lesk | glossy

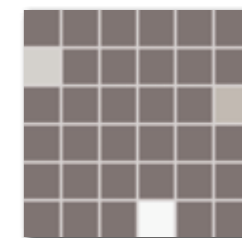

WDM05011 (SET)
66 / set
lesk | glossy



33x33
R9
v2

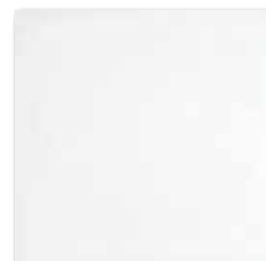

DAA3B599
Concept
PEI 4 76 / m²
mat | matt

bílá / white / biata / белый / fehér / blanco



DAA3B600
Concept
PEI 4 76 / m²
mat | matt

béžová / beige / bežowa
бежевый / bézs / beige



DAA3B601
Concept
PEI 3 76 / m²
mat | matt

hnědá / brown / brązowa / коричневый
barna / marrón



DAA3B602
Concept
PEI 4 76 / m²
mat | matt

šedá / grey / szara / серый
szürke / gris



DAA3B603
Concept
PEI 3 76 / m²
mat | matt

černá / black / czarna / черный
fekete / negro

výrobek / product	cm	mm	EN	ks/m ²	m ²	m ²	kg	kg/m ²	brutto kg	
obkladáčka / wall tile	25x33	250x330x7	EN 14411:2016, annex L BIII GL	18	12	1,50	54	81,00	18,6	1 030
inzerťo / insert	25x10	250x100x7	EN 14411:2016, annex L BIII GL	20	40	0,50	-	-	6,3	-
mozaika set 30x30 cm / mosaic sheet 30x30 cm	5x5	48x48x7	STO é. 030 - 049913	3	11	0,27	-	-	3,5	12,9
dlaždice / floor tile	33x33	333x333x8	EN 14411:2016, annex G BIIa GL	12	9	1,33	44	58,52	23,6	1 061



25x33
v1

25x10

30x30

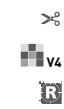

v4



33x33
R9
v2





30x60
30x90

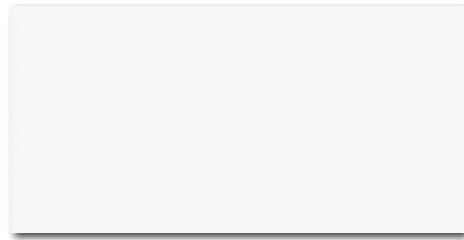

WAKV4104
○ 84 / m²
mat | matt | ■ V1

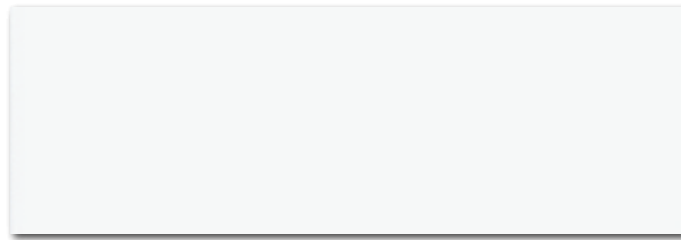

WAKV5104
○ 88 / m²
mat | matt | ■ V1

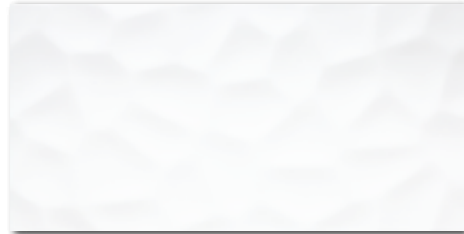

WR2V4104
○ 86 / m²
mat | matt | ■ V2
biłá / white / biata / бeлый / fehér / blanco

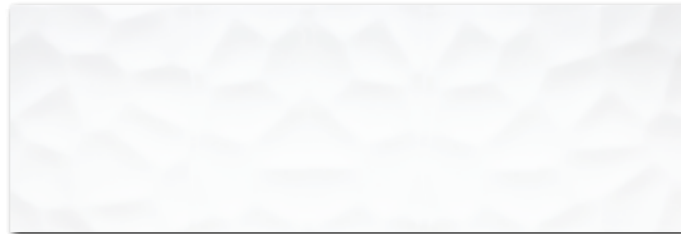

WR2V5104
○ 92 / m²
mat | matt | ■ V2

news

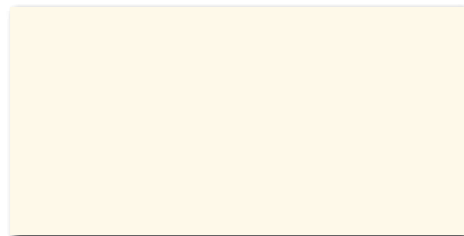

WAKV4107
○ 84 / m²
mat | matt | ■ V1

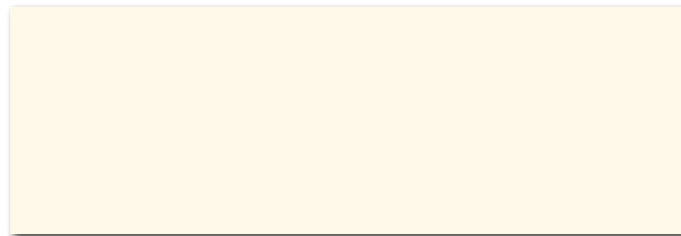

WAKV5107
○ 88 / m²
mat | matt | ■ V1

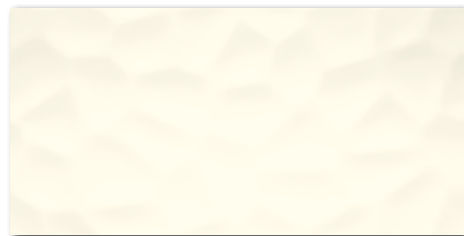

WR2V4107
○ 86 / m²
mat | matt | ■ V2
světle béžová / light beige
jasnobéžová / светло-бежевый / világosbézs / beige claro

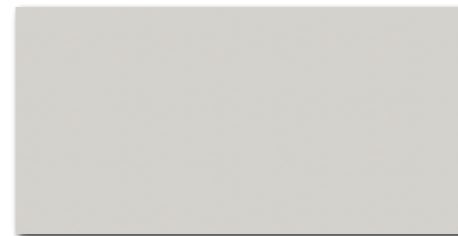

WAKV4112
○ 84 / m²
mat | matt | ■ V1

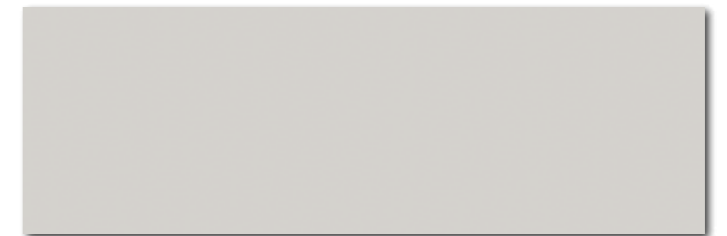

WAKV5112
○ 88 / m²
mat | matt | ■ V1



WR2V4112
○ 86 / m²
mat | matt | ■ V2
světle šedá / light grey / jasnoszara / светло-серый
világosszürke / gris claro



WAKV4108
○ 84 / m²
mat | matt | ■ V1



WAKV5108
○ 88 / m²
mat | matt | ■ V1

béžová / beige / bežowa / бежевый / bézs / beige



WAKV4110
○ 84 / m²
mat | matt | ■ V1



WAKV5110
○ 88 / m²
mat | matt | ■ V1

šedá / grey / szara / серый / szürke / gris

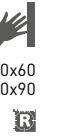

30x60
30x90



výrobek / product



obkládačka / wall tile	30x60	298x598x10	EN 14411:2016, annex L BIII GL	6	5,56	1,08	40	43,20	20,0	18,5	825
obkládačka / wall tile	30x90	298x898x10,5	EN 14411:2016, annex L BIII GL	4	3,7	1,08	30	32,40	21,7	20,1	677

30x60
20x60
v1



WAAV4104
○ 78 / m²
mat | matt
bílá / white / biata / белый / fehér / blanco

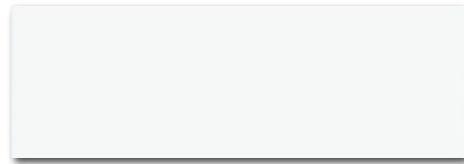

WAAVE104
○ 78 / m²
mat | matt

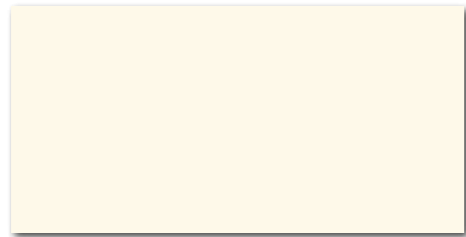

WAAV4107
○ 80 / m²
mat | matt
světle béžová / light beige / jasnobežowa / светло-бежевый
világosbézs / beige claro

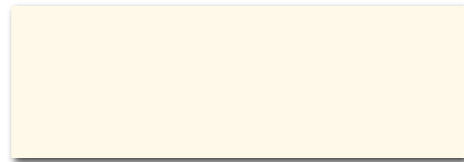

WAAVE107
○ 80 / m²
mat | matt

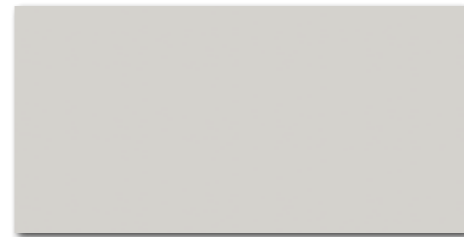

WAAV4112
○ 80 / m²
mat | matt
světle šedá / light grey / jasnoszara / светло-серый
világosszürke / gris claro

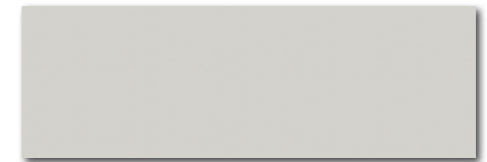

WAAVE112
○ 80 / m²
mat | matt

30x60
15x60
v1

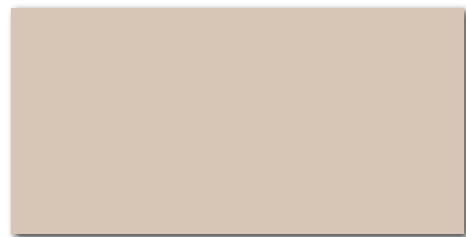

WAAV4108
○ 80 / m²
mat | matt
béžová / beige / bežowa / бежевый / bézs / beige

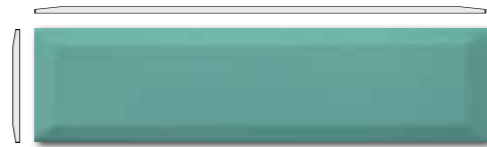

WARSU467
○ 58 / ks
mat | matt
tyrkysová / turquoise / turkusowa / цвет морской волны
türkiz / turquesa

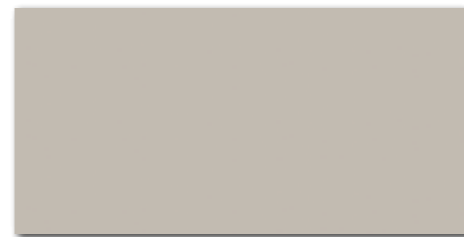

WAAV4110
○ 80 / m²
mat | matt
šedá / grey / szara / серый / szürke / gris



WARSU464
○ 58 / ks
mat | matt
žlutozelená / yellow-green / zólto-zielony
jelto-zelény / sárga-zöld / amarillo-verde

45x45
R9
v2

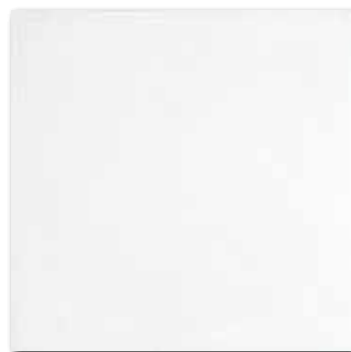

DAA44599
PEI 4 ○ 76 / m²
mat | matt
bílá / white / biata / белый / fehér / blanco



DAA44600
PEI 4 ○ 76 / m²
mat | matt
béžová / beige / bežowa / бежевый
bézs / beige



DAA44601
PEI 3 ○ 76 / m²
mat | matt
hnědá / brown / brązowa / коричневый
barna / marrón



DAA44602
PEI 4 ○ 76 / m²
mat | matt
šedá / grey / szara / серый / szürke / gris



DAA44603
PEI 3 ○ 76 / m²
mat | matt
černá / black / czarna / черный / fekete / negro

30x60
20x60
v1

30x60
20x60
v1

30x60
15x60
v1

45x45
R9
v2

výrobek / product	mm	mm	EN	ks/m ²	m ²	m ²	kg	kg/m ²	brutto kg		
obkládačka / wall tile	30x60	298x598x10	EN 14411:2016, annex L BIII GL	6	5,56	1,08	40	43,20	20,0	18,5	825
obkládačka / wall tile	20x60	198x598x10	EN 14411:2016, annex L BIII GL	9	8,3	1,08	42	45,36	20,0	18,5	865
inseto / insert	15x60	148x598x10	EN 14411:2016, annex L BIII GL	8	11,1	0,72	-	-	13,3	18,5	-
dlaždice / floor tile	45x45	448x448x10	EN 14411:2016, annex G BIa GL	6	5	1,21	26	31,46	25,0	20,7	677



20x40
v1

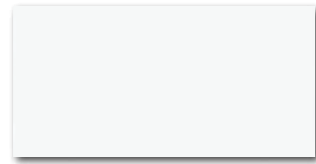

WAAMB104
72 / m²
mat | matt

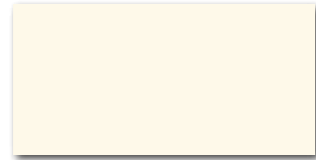

WAAMB107
74 / m²
mat | matt
světle béžová / light beige / jasnożółta
светло-бежевый / világosbézs / beige claro

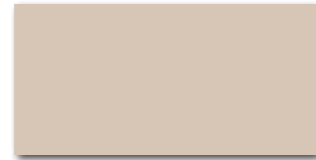

WAAMB108
74 / m²
mat | matt
béžová / beige / beżowa / бежевый
bézs / beige

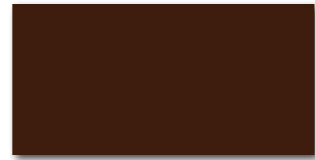

WAAMB109
74 / m²
mat | matt
hnědá / brown / brązowa / коричневый
barna / marrón

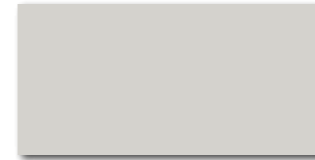

WAAMB112
74 / m²
mat | matt
světle šedá / light grey / jasnoszara
светло-серый / világosszürke / gris claro

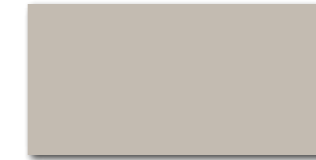

WAAMB110
74 / m²
mat | matt
šedá / grey / szara / серый / szürke / gris

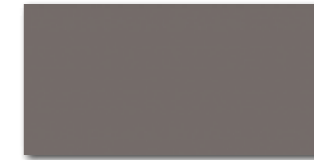

WAAMB111
74 / m²
mat | matt
tmavě šedá / dark grey / ciemnoszara
темно-серый / sötétszürke / gris oscuro



20x40
v1

20x40
40x4,3



WITMB029
Interia
64 / ks
mat | matt



WLAMH004
Interia
52 / ks
mat | matt

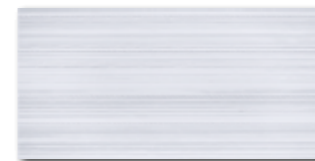

WITMB030
Interia
64 / ks
mat | matt

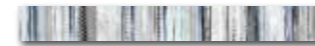

WLAMH008
Interia
52 / ks
mat | matt

20x40
40x4,3

20x40



WITMB021
Monopoli
58 / ks
mat/lesk | matt/glossy



WITMB022
Monopoli
58 / ks
mat/lesk | matt/glossy

20x40

40x4,5



WLAMH010
Monopoli
46 / ks
lesk | glossy



WLAMH011
Monopoli
46 / ks
lesk | glossy



WLAMH012
Monopoli
46 / ks
lesk | glossy



WLAMH013
Monopoli
46 / ks
lesk | glossy

40x4,5

20x3

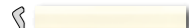

WLRDH030
32 / ks
mat | matt



WLRDH031
32 / ks
mat | matt



WLRDH032
32 / ks
mat | matt



WLRDH035
32 / ks
mat | matt



WLRDH033
32 / ks
mat | matt



WLRDH034
32 / ks
mat | matt

20x3

výrobek / product



	20x40	198x398x7	EN 14411:2016, annex L BIII GL	20	12,5	1,60	48	76,80	20,6	12,9	1 016
obkládačka / wall tile	20x40	198x398x7	EN 14411:2016, annex L BIII GL	4	12,5	0,32	-	-	3,8	11,8	-
inzerťo / insert	40x4,3	398x43x7	EN 14411:2016, annex L BIII GL	12	58,4	0,20	-	-	2,3	13,5	-
listela / listel	40x4,5	398x45x7	EN 14411:2016, annex L BIII GL	12	55,6	0,22	-	-	2,8	13,0	-
reliefní listela / relief listel	20x3	198x30	STO č. 030 - 054498	18	167	0,11	-	-	1,7	15,8	-

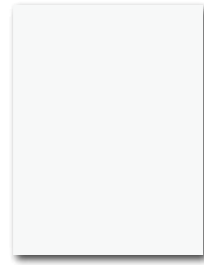

WAAKB104
 ○ 72 / m²
 mat | matt
 bílá / white / biata / белый
 fehér / blanco

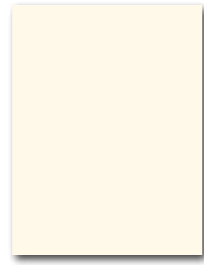

WAAKB107
 ○ 74 / m²
 mat | matt



WAAKB108
 ○ 74 / m²
 mat | matt



WAAKB109
 ○ 74 / m²
 mat | matt



WAAKB112
 ○ 74 / m²
 mat | matt



WAAKB110
 ○ 74 / m²
 mat | matt



WAAKB111
 ○ 74 / m²
 mat | matt

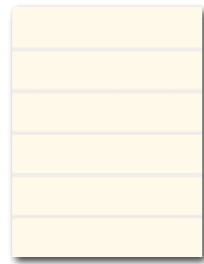

WIFKB107
 Akcent
 ○ 52 / ks
 mat | matt
 světle béžová / light beige
 jasnobéžová / светло-бежевый
 világosbézs / beige claro

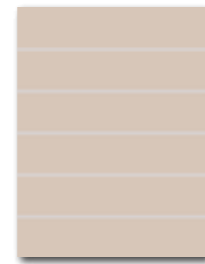

WIFKB108
 Akcent
 ○ 52 / ks
 mat | matt
 béžová / beige / bežowa
 бежевый / bézs / beige



WIFKB109
 Akcent
 ○ 52 / ks
 mat | matt
 hnědá / brown / brązowa
 коричневый / barna / marrón

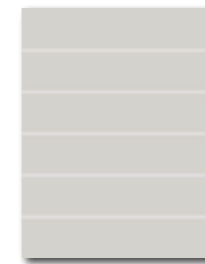

WIFKB112
 Akcent
 ○ 52 / ks
 mat | matt
 světle šedá / light grey
 jasnoszara / светло-серый
 világosszürke / gris claro

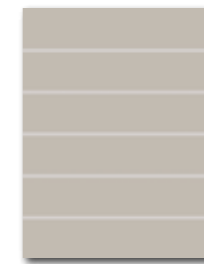

WIFKB110
 Akcent
 ○ 52 / ks
 mat | matt
 šedá / grey / szara
 серый / szürke / gris

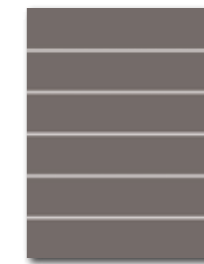

WIFKB111
 Akcent
 ○ 52 / ks
 mat | matt
 tmavě šedá / dark grey
 ciemnoszara / темно-серый
 sötétszürke / gris oscuro



WLAH5010
 Monopoli
 ○ 42 / ks
 lesk | glossy



VLAG8001
 Akcent
 ○ 34 / ks
 lesk | glossy



WLAH5012
 Monopoli
 ○ 42 / ks
 lesk | glossy



VLAG8002
 Akcent
 ○ 34 / ks
 lesk | glossy



WLAH5011
 Monopoli
 ○ 42 / ks
 lesk | glossy



WLAH5013
 Monopoli
 ○ 42 / ks
 lesk | glossy

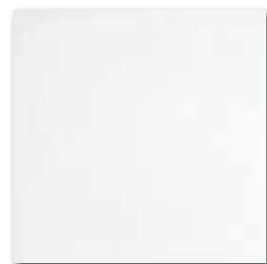

DAA3B599
 PEI 4 ○ 76 / m²
 mat | matt
 bílá / white / biata / белый
 fehér / blanco



DAA3B600
 PEI 4 ○ 76 / m²
 mat | matt
 béžová / beige / bežowa
 бежевый / bézs / beige



DAA3B601
 PEI 3 ○ 76 / m²
 mat | matt
 hnědá / brown / brązowa
 коричневый / barna / marrón



DAA3B602
 PEI 4 ○ 76 / m²
 mat | matt
 šedá / grey / szara / серый
 szürke / gris



DAA3B603
 PEI 3 ○ 76 / m²
 mat | matt
 černá / black / czarna / черный
 fekete / negro

výrobek / product



	25x33	250x330x7	EN 14411:2016, annex L BIII GL	18	12	1,50	54	81,00	18,6	12,4	1 030
obkládačka / wall tile	25x33	250x330x7	EN 14411:2016, annex L BIII GL	4	12	0,33	50	16,50	4,1	12,4	230
inzerťo / insert	25x4,5	250x45x7	EN 14411:2016, annex L BIII GL	12	88,9	0,14	-	-	2,0	14,7	-
listela / listel	25x1,5	250x15x6	STO č. 030 - 049913	30	266,7	0,11	-	-	2,7	24,5	-
dlaždice / floor tile	33x33	333x333x8	EN 14411:2016, annex G BIIa GL	12	9	1,33	44	58,52	23,6	17,7	1 061



20x40
v2

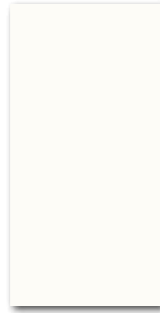

WATMB020
○ 68 / m²
lesk | glossy



WATMB021
○ 68 / m²
lesk | glossy



WATMB022
○ 68 / m²
lesk | glossy

20x40 / 4,3x40



WITMB009
○ 58 / ks
lesk | glossy
biłá / white / biata
белый / fehér / blanco



WITMB011
○ 58 / ks
lesk | glossy



WLAMH001
○ 46 / ks
lesk | glossy



WITMB012
○ 58 / ks
lesk | glossy



WLAMH002
○ 46 / ks
lesk | glossy

20x3



WLRDH121
○ 32 / ks
lesk | glossy



WLRDH122
○ 32 / ks
lesk | glossy



30x30



v2



GDMAJ007 (SET)
PEI 4 ○ 58 / set
lesk | glossy



GDMAJ008 (SET)
PEI 3 ○ 58 / set
lesk | glossy

33x33

v2



GAT3B194
PEI 4 ○ 74 / m²
mat | matt
oranžová / orange / pomarańczowa
оранжевый / narancs / naranja



GAT3B195
PEI 3 ○ 74 / m²
mat | matt
hnědá / brown / brązowa
коричневый / barna / marrón

výrobek / product	cm	mm	EN	ks/m ²	m ²	kg	kg/m ²	brutto kg
obkládačka / wall tile	20x40	198x398x7	EN 14411:2016, annex L BIII GL	20	12,5	1,60	48	76,80
inzerťo / insert	20x40	198x398x7	EN 14411:2016, annex L BIII GL	4	12,5	0,32	-	-
listela / listel	40x4,3	398x43x7	EN 14411:2016, annex L BIII GL	12	55,5	0,22	-	-
reliéfní listela / relief listel	20x3	198x30	STO č. 030 - 054498	18	167	0,11	-	-
mozaika set 30x30 cm / mosaic sheet 30x30 cm	2,5x7,5	23x73x6	STO č. 030 - 049913	4	11	0,36	150	54,55
dlaždice / floor tile	33x33	333x333x8	EN 14411:2016, annex H BIII GL	12	9	1,33	44	58,52



25x33
v2

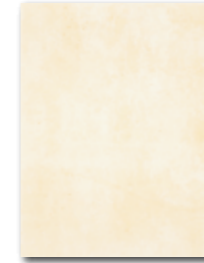

WATKB230
○ 59 / m²
mat | matt



WATKB231
○ 59 / m²
mat | matt



WATKB232
○ 59 / m²
mat | matt



WARKB230
○ 74 / m²
mat | matt



WARKB231
○ 74 / m²
mat | matt



WARKB232
○ 74 / m²
mat | matt



WILKB230
○ 52 / ks
mat | matt



WLAGE230 (SET)
○ 42 / set
mat | matt



GAT3B230
PEI 4 ○ 68 / m²
mat | matt
světle béžová / light beige
jasnobežová / светло-бежевый
világosbézs / beige claro



GAT3B231
PEI 3 ○ 68 / m²
mat | matt
cihlová / brick / ceglata
кирпичный / tegla / ladrillo



GAT3B232
PEI 3 ○ 68 / m²
mat | matt
šedoběžová / grey-beige
szaro-bežowa / серо-бежевый
szurke-bezs / gris-amarillento

výrobek / product	cm	mm	EN	ks/m ²	m ²	kg	kg/m ²	brutto kg
obkládačka / wall tile	25x33	250x330x7	EN 14411:2016, annex L BIII GL	18	12	1,50	54	81,00
inzerťo / insert	25x33	250x330x7	EN 14411:2016, annex L BIII GL	4	12	0,33	-	-
listela / listel (set)	25x5	250x50x7	EN 14411:2016, annex L BIII GL	7	-	-	-	-
dlaždice / floor tile	33x33	333x333x8	EN 14411:2016, annex H BIII GL	12	9	1,33	44	58,52

25x5



33x33

v2



25x33
v2



WATKB146
59 / m²
lesk | glossy



WATKB147
59 / m²
lesk | glossy



WATKB148
59 / m²
lesk | glossy



WATKB149
59 / m²
lesk | glossy



WITKB146
58 / ks
lesk | glossy



WITKB147
58 / ks
lesk | glossy



WITKB148
58 / ks
lesk | glossy



WITKB149
58 / ks
lesk | glossy

25x5



WLAGE146
40 / ks
lesk | glossy

světle béžová / light beige
jasnobeżowa
светло-бежевый
világosbézs / beige claro



WLAGE147
40 / ks
lesk | glossy



WLAGE148
40 / ks
lesk | glossy

šedohnědá / grey-brown
szarobrazowa
серо-коричневый
barna-szürke
gris-marrón



WLAGE149
40 / ks
lesk | glossy



33x33
v2



DAA3B606
Remix
PEI 4 72 / m²
mat | matt
oranžová / orange / pomarańczowa
оранжевый / narancs / naranja

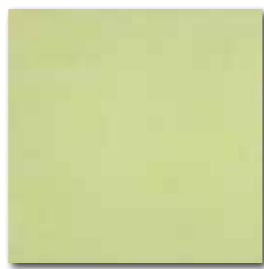

DAA3B607
Remix
PEI 4 72 / m²
mat | matt
zelená / green / zielona
зеленый / zold / verde



WARKA070
64 / m²
mat | matt



WILKA002
68 / ks
mat | matt



WLRGE060
40 / ks
mat | matt



WLRGA060
36 / ks
mat | matt
bílá / white / biata / белый
fehér / blanco



WARKA071
64 / m²
mat | matt



WLAGE016
42 / ks
mat | matt



WLAEE002
38 / ks
mat | matt



WLRGE061
40 / ks
mat | matt

WLRGA061
36 / ks
mat | matt



WARKA072
64 / m²
mat | matt



WLRGE062
40 / ks
mat | matt



WLRGA062
36 / ks
mat | matt



GDM02115 [SET]
PEI 4 58 / set
mat | matt
vícebarevná / multicoloured / kolorowa
многоцветный / többszínű / multicolor



GAT3B114
PEI 4 70 / m²
mat | matt
žlutá / yellow / zółta
желтый / sárga / ámbar



GAT3B115
PEI 4 70 / m²
mat | matt
cihlová / brick / ceglata
кирпичный / téгла / ladrillo luz



25x33
v2

25x33
7,8x33
25x5,2
7,8x5,2

25x5

25x2,3



30x30
v4

33x33



v2

výrobek / product



výrobek / product	cm	mm	EN	ks/m ²	m ²	kg	kg/m ²	brutto kg
obkládačka / wall tile	25x33	250x330x7	EN 14411:2016, annex L BIII GL	18	12	1,50	54	81,00
inzerťo / insert	25x33	250x330x7	EN 14411:2016, annex L BIII GL	4	12	0,33	-	-
listela / listel	25x5	250x50x7	EN 14411:2016, annex L BIII GL	14	-	-	-	-
dlaždice / floor tile	33x33	333x333x8	EN 14411:2016, annex G BIIa GL	12	9	1,33	44	58,52
listela / listel	33x7,8	330x78x7	EN 14411:2016, annex L BIII GL	12	39	0,31	-	-
listela / listel	25x5,2	250x52x7	EN 14411:2016, annex L BIII GL	14	77	0,18	-	-
listela / listel	7,8x5,2	78x52x7	EN 14411:2016, annex L BIII GL	4	247	0,02	-	-
reliéfní listela / relief listel	25x5	250x50	STO č. 030 - 054498	14	80	0,18	-	-
reliéfní listela / relief listel	25x2,3	250x23	STO č. 030 - 054498	14	174	0,08	-	-
mozaika set 30x30 cm / mosaic sheet 30x30 cm	2,5x2,5	23x23x6	STO č. 030 - 049913	4	11	0,36	150	54,55
dlaždice / floor tile	33x33	333x333x8	EN 14411:2016, annex H BIIb GL	12	9	1,33	44	58,52



25x33
V2



WARKB015
Ø 62 / m²
mat | matt



WARKB019
Ø 62 / m²
mat | matt



WARKB016
Ø 62 / m²
mat | matt



WARKB018
Ø 62 / m²
mat | matt



WARKB017
Ø 62 / m²
mat | matt

25x33
11,8x33



WITKB090
Ø 58 / ks
mat | matt



WLAKM090
Ø 52 / ks
mat | matt



WITKB091
Ø 58 / ks
mat | matt



WLAKM091
Ø 52 / ks
mat | matt

25x4,3



WLAH5015
Ø 38 / ks
lesk | glossy

bílá / white / biata / белый
fehér / blanco



WLAH5019
Ø 38 / ks
lesk | glossy



WLAH5016
Ø 38 / ks
lesk | glossy



WLAH5018
Ø 38 / ks
lesk | glossy



WLAH5017
Ø 38 / ks
lesk | glossy

25x5



WLRGE127
Ø 32 / ks
mat | matt



WLRGE124
Ø 32 / ks
mat | matt



WLRGE126
Ø 32 / ks
mat | matt



WLRGE125
Ø 32 / ks
mat | matt

25x2,3

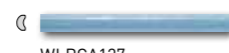

WLRGA127
Ø 28 / ks
mat | matt

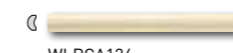

WLRGA124
Ø 28 / ks
mat | matt

světle béžová / light beige
jasno-bežowa
светло-бежевый
világosbézs / beige claro

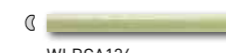

WLRGA126
Ø 28 / ks
mat | matt

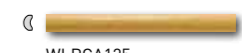

WLRGA125
Ø 28 / ks
mat | matt



33x33



V2



DAA3B608
PEI 4 Ø 72 / m²
mat | matt

modrá / blue / niebieska / синий
kék / azul



DAA3B607
PEI 4 Ø 72 / m²
mat | matt

zelená / green / zielona
зеленый / zöld / verde



DAA3B606
PEI 4 Ø 72 / m²
mat | matt

oranžová / orange / pomarańczowa
оранжевый / narancs / naranja

výrobek / product



EN



výrobek / product	cm	mm	EN	kg	kg/m ²	m ²	m ²	m ²	kg	kg/m ²	brutto kg
obkládačka / wall tile	25x33	250x330x7	EN 14411:2016, annex L BIII GL	18	12	1,50	54	81,00	18,6	12,4	1 030
inzerťo / insert	25x33	250x330x7	EN 14411:2016, annex L BIII GL	4	12	0,33	-	-	4,1	12,4	-
listela / listela	11,8x33	118x330x7	EN 14411:2016, annex L BIII GL	6	25,7	0,23	-	-	2,9	12,4	-
listela / listela	25x4,3	250x43x7	EN 14411:2016, annex L BIII GL	12	93	0,13	-	-	1,6	12,0	-
reliefní listela / relief listel	25x5	250x50	STO č. 030 - 054498	14	80	0,18	-	-	3,2	18,2	-
reliefní listela / relief listel	25x2,3	250x23	STO č. 030 - 054498	14	174	0,08	-	-	1,6	20,0	-
dlaždice / floor tile	33x33	333x333x8	EN 14411:2016, annex G BIIa GL	12	9	1,33	44	58,52	23,6	17,7	1 061

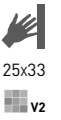

25x33
V2

25x33
11,8x33

25x4,3

25x5

25x2,3



33x33



V2



20x25



WATGY145
○ 56 / m²
lesk | glossy

svetle béžová / light beige / jasnobežowa
светло-бежевый / világosbézs / beige claro



WATGY147
○ 56 / m²
lesk | glossy

svetle modrá / light blue / jasnoliebieska
светло-голубой / világoskék / azul claro



WATGY149
○ 56 / m²
lesk | glossy

svetle šedá / light grey / jasnoszara
светло-серый / világosszürke / gris claro



WATGY146
○ 56 / m²
lesk | glossy



WATGY148
○ 56 / m²
lesk | glossy



WATGY150
○ 56 / m²
lesk | glossy

20x6



WLAED015
○ 22 / ks
lesk | glossy



WLAED016
○ 22 / ks
lesk | glossy



WLAED017
○ 22 / ks
lesk | glossy

20x5

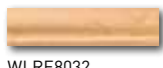

WLRE8032
○ 26 / ks
lesk | glossy

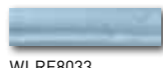

WLRE8033
○ 26 / ks
lesk | glossy

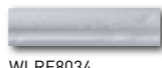

WLRE8034
○ 26 / ks
lesk | glossy



30x30



GAT2J154
PEI 4 ○ 68 / m²
mat | matt

běžová / beige / bežowa
бежевый / bézs / beige



GAT2J155
PEI 4 ○ 68 / m²
mat | matt

modrá / blue / niebieska
голубой / kék / azul



GAT2J156
PEI 4 ○ 68 / m²
mat | matt

šedá / grey / szara
серый / szürke / gris



20x25



WATGY350
○ 56 / m²
mat | matt

svetle cihlová / light brick
jasnoceglasta / светло-кирпичный
világostégla / ladrillo luz



WATGY351
○ 56 / m²
mat | matt

svetle žlutá / light yellow
jasnozöta / светло-желтый
világossárga / amarillo claro

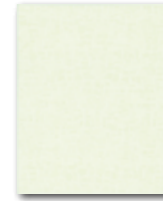

WATGY352
○ 56 / m²
mat | matt

svetle zelená / light green
jasnozielona / светло-зеленый
világoszöld / verde claro



WATGY353
○ 56 / m²
mat | matt



WATGY354
○ 56 / m²
mat | matt



WATGY355
○ 56 / m²
mat | matt



WITGY350
○ 40 / ks
mat/lesk | matt/glossy



WITGY351
○ 40 / ks
mat/lesk | matt/glossy



WITGY352
○ 40 / ks
mat/lesk | matt/glossy

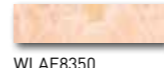

WLAE8350
○ 24 / ks
lesk | glossy

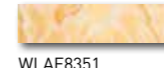

WLAE8351
○ 24 / ks
lesk | glossy

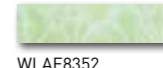

WLAE8352
○ 24 / ks
lesk | glossy

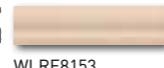

WLRE8153
○ 26 / ks
mat | matt

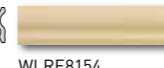

WLRE8154
○ 26 / ks
mat | matt

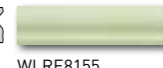

WLRE8155
○ 26 / ks
mat | matt



WLRE6153
○ 24 / ks
mat | matt

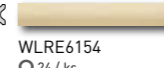

WLRE6154
○ 24 / ks
mat | matt

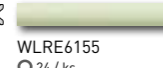

WLRE6155
○ 24 / ks
mat | matt



GAT2J160
PEI 4 ○ 68 / m²
mat | matt

cihlová / brick / ceglasta / кирпичный
tégla / ladrillo



GAT2J161
PEI 4 ○ 68 / m²
mat | matt

žlutá / yellow / zöta
желтый / sárga / ámbar



GAT2J162
PEI 4 ○ 68 / m²
mat | matt

zelená / green / zielona
зеленый / zöld / verde

20x5

20x3



30x30



výrobek / product	cm	mm	EN	ks/m ²	m ²	m ³	kg	kg/m ²	brutto kg	
obkládačka / wall tile	20x25	198x248x6,8	EN 14411:2016, annex L BIII GL	30	20	1,50	60	90,00	17,6	1 078
listela / listel	20x6	198x60x6,8	EN 14411:2016, annex L BIII GL	18	82	0,22	-	-	2,6	11,9
reliéfni listela / relief listel	20x5	198x50	STO č. 030 - 054498	18	100	0,18	-	-	3,3	18,5
inzerťo / insert	20x25	198x248x6,8	EN 14411:2016, annex L BIII GL	4	20	0,20	-	-	2,3	11,7
listela / listel	20x5	198x50x6,8	EN 14411:2016, annex L BIII GL	18	100	0,18	-	-	2,7	15,6
reliéfni listela / relief listel	20x5	198x50	STO č. 030 - 054498	18	100	0,18	-	-	2,6	14,6
reliéfni listela / relief listel	20x3	198x30	STO č. 030 - 054498	18	167	0,11	-	-	2,0	18,7
dlaždice / floor tile	30x30	298x298x8	EN 14411:2016, annex H BIIb GL	13	11	1,18	48	56,64	21,0	1 034



WADV4050
78 / m²
lesk | glossy

WADV4150
78 / m²
mat | matt



WADV4051
78 / m²
lesk | glossy

WADV4151
78 / m²
mat | matt



WATKB099
64 / m²
lesk | glossy

WATKB101
64 / m²
mat | matt



WATKB098
64 / m²
lesk | glossy

WATKB100
64 / m²
mat | matt



DDPSZ002
Light
60 / ks
mat | matt



DDPSZ001
Light
60 / ks
mat | matt



DDM0U610 (SET)
Unistone
PEI 5 82 / set
mat | matt

běžová / beige / bežowa
бежевый / bézs / beige



DDM06610 (SET)
Unistone
PEI 5 72 / set
mat | matt

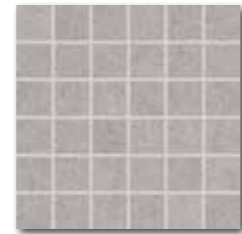

DDM06634 (SET)
Rock
PEI 5 72 / set
mat | matt

světle šedá / light grey /
jasnoszara / светло-серый
világosszürke / gris claro



DDP34634 (SET)
Rock
PEI 5 72 / set
mat | matt



WATG6023
59 / m²
lesk | glossy

WATG6025
59 / m²
mat | matt

běžová / beige / bežowa
бежевый / bézs / beige



WATG6022
59 / m²
lesk | glossy

WATG6024
59 / m²
mat | matt

šedá / grey / szara / серый
szürke / gris



DAA3B609
Unistone
PEI 5 70 / m²
mat | matt

bílá / white / biata / белый
fehér / blanco



DAA3B610
Unistone
PEI 5 70 / m²
mat | matt

běžová / beige / bežowa / бежевый
bézs / beige



DAA3B612
Unistone
PEI 5 70 / m²
mat | matt

šedohnědá / grey-brown /
szarobrazowa / серо-коричневый /
barna-szürke / gris-marrón



DAA3B611
Unistone
PEI 5 70 / m²
mat | matt

šedá / grey / szara / серый
szürke / gris



DAA34633
Rock
PEI 5 72 / m²
mat | matt

stonová kost / ivory /
kość słoniowa / слоновья кость
elefántcsont / marfil



DAA34632
Rock
PEI 5 72 / m²
mat | matt

bílá / white / biata / белый
fehér / blanco



DAA34634
Rock
PEI 5 72 / m²
mat | matt

světle šedá / light grey
jasnoszara / светло-серый
világosszürke / gris claro



DAA34636
Rock
PEI 5 72 / m²
mat | matt

tmavě šedá / dark grey
ciemnoszara / темно-серый
sötétszürke / gris oscuro



DAA34635
Rock
PEI 5 72 / m²
mat | matt

černá / black / czarna / черный
fekete / negro



výrobek / product	cm	mm	EN	ks/m ²	m ²	m ²	kg	kg/m ²	brutto kg		
obkládačka / wall tile	30x60	298x598x10	EN 14411:2016, annex L BIII GL	6	5,56	1,08	40	43,20	20,0	18,5	825
listela / listel	60x5,6	598x56x10	EN 14411:2016, annex G BIIa GL	8	29,9	0,27	-	-	6,4	26,7	-
mozaika set 30x30 cm / mosaic sheet 30x30 cm	2,5x2,5	23x23x10	STO č. 030 - 049913	3	11	0,27	-	-	5,8	21,5	-
mozaika set 30x30 cm / mosaic sheet 30x30 cm	5x5	48x48x10	STO č. 030 - 049913	3	11	0,27	-	-	5,8	21,5	-
inzerť / insert	30x30	298x298x10	STO č. 030 - 049913	3	11	0,27	-	-	5,8	21,5	-
dlaždice / floor tile (DAA3B...)	33x33	33x33x8	EN 14411:2016, annex G BIIa GL	12	9	1,33	44	58,52	23,6	17,7	1 061
obkládačka / wall tile	25x33	250x330x7	EN 14411:2016, annex L BIII GL	18	12	1,50	54	81,00	18,6	12,4	1 030
obkládačka / wall tile	20x25	198x248x6,8	EN 14411:2016, annex L BIII GL	30	20	1,50	60	90,00	17,6	11,7	1 078
dlaždice / floor tile (DAA34...)	30x30	298x298x8	EN 14411:2016, annex G BIIa GL	13	11	1,18	48	56,64	21,0	17,8	1 034

serie lucie



20x25
v2

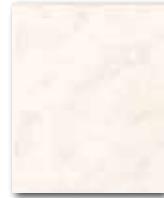

WAAGX103
○ 56 / m²
lesk | glossy



WAAGX105
○ 56 / m²
mat | matt

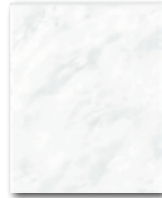

WAAGX104
○ 56 / m²
lesk | glossy

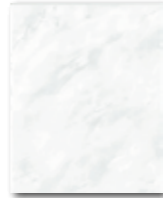

WAAGX106
○ 56 / m²
mat | matt



WITGX113
○ 32 / ks
lesk | glossy



WITGX110
○ 32 / ks
lesk | glossy

20x6,1



WLAED113
○ 20 / ks
lesk | glossy



WLAED115
○ 24 / ks
mat | matt



WLAED110
○ 20 / ks
lesk | glossy



WLAED114
○ 24 / ks
mat | matt

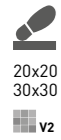

20x20
30x30
v2



GAT24739
PEI 4 ○ 64 / m²
mat | matt

běžová / beige / beżowa
бежевый / бэзс / beige



GAT2J739
PEI 4 ○ 64 / m²
mat | matt



GAT24740
PEI 4 ○ 64 / m²
mat | matt

šedá / grey / szara
серый / szürke / gris



GAT2J740
PEI 4 ○ 64 / m²
mat | matt

serie marmo

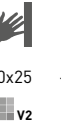

20x25
v2

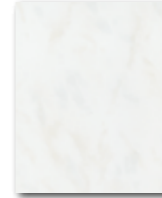

WATG6038
○ 56 / m²
lesk | glossy



WATG6039
○ 56 / m²
mat | matt



WATG6040
○ 56 / m²
lesk | glossy



WATG6041
○ 56 / m²
mat | matt



WATKB177
○ 62 / m²
lesk | glossy
běžová / beige / beżowa
бежевый / бэзс / beige



WATKB178
○ 62 / m²
mat | matt



WATKB179
○ 62 / m²
lesk | glossy
šedá / grey / szara
серый / szürke / gris

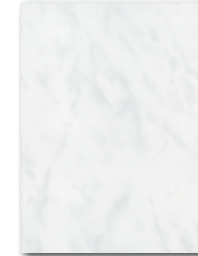

WATKB180
○ 62 / m²
mat | matt

25x33
v2

výrobek / product



EN



	cm	mm	EN	ks/m ²	m ²	m ²	m ²	kg	kg/m ²	brutto kg	
obkládačka / wall tile	20x25	198x248x6,8	EN 14411:2016, annex L BIII GL	30	20	1,50	60	90,00	17,6	11,7	1 078
inzerťo / insert	20x25	198x248x6,8	EN 14411:2016, annex L BIII GL	4	20	0,20	-	-	2,3	11,7	-
listela / listel	20x6,1	198x61x6,8	EN 14411:2016, annex L BIII GL	18	82	0,22	-	-	2,5	11,5	-
dlaždice / floor tile	20x20	198x198x7	EN 14411:2016, annex H BIb GL	25	25	1,00	72	72,00	15,5	15,5	1 141
dlaždice / floor tile	30x30	297x297x8	EN 14411:2016, annex H BIa GL	11	11	1,00	64	64,00	17,5	17,5	1 145
dlaždice / floor tile	30x30	298x298x8	EN 14411:2016, annex H BIb GL	13	11	1,18	48	56,64	21,0	17,8	1 034
obkládačka / wall tile	25x33	250x330x7	EN 14411:2016, annex L BIII GL	18	12	1,50	54	81,00	18,6	12,4	1 030



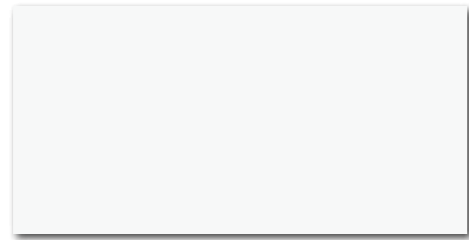
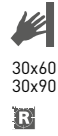

WAKV4000
○ 84 / m²
lesk | glossy | **V1**

WAKV4104
○ 84 / m²
mat | matt | **V1**

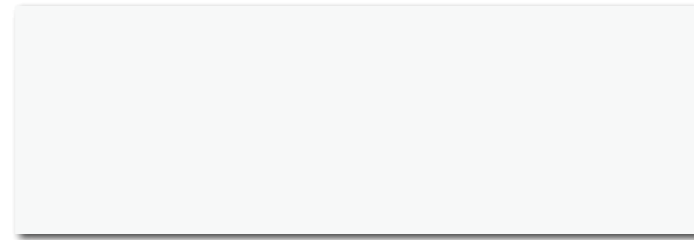

WAKV5000
○ 88 / m²
lesk | glossy | **V1**

WAKV5104
○ 88 / m²
mat | matt | **V1**

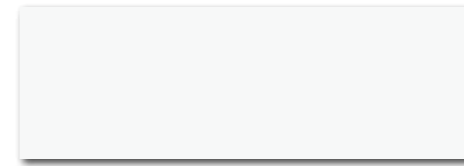

WAAVE000
○ 78 / m²
lesk | glossy

WAAVE104
○ 78 / m²
mat | matt

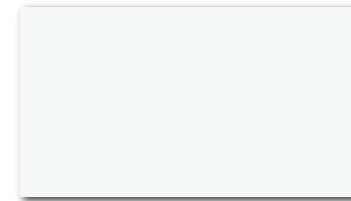

WAAP3000
○ 76 / m²
lesk | glossy

WAAP3104
○ 76 / m²
mat | matt

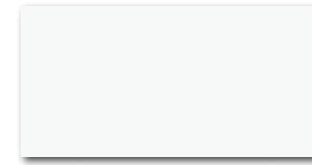

WAAMB000
○ 72 / m²
lesk | glossy

WAAMB104
○ 72 / m²
mat | matt

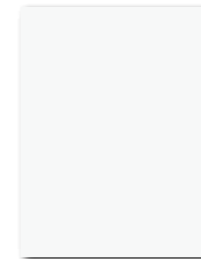

WAAKB000
○ 72 / m²
lesk | glossy | **V1**

WAAKB104
○ 72 / m²
mat | matt | **V1**



WARKB000
○ 72 / m²
lesk | glossy | **V2**

WARKB104
○ 72 / m²
mat | matt | **V2**

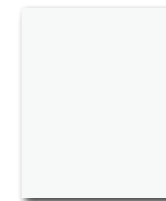

WAAG6000
○ 70 / m²
lesk | glossy | **V1**

WAAG6104
○ 70 / m²
mat | matt | **V1**

bílá / white / biata / белый / fehér / blanco



WARG6000
○ 68 / m²
lesk | glossy | **V2**

WARG6104
○ 68 / m²
mat | matt | **V2**

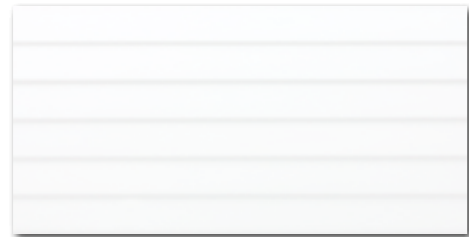

WR1V4000
○ 86 / m²
lesk | glossy | **V2**

WR1V4104
○ 86 / m²
mat | matt | **V2**

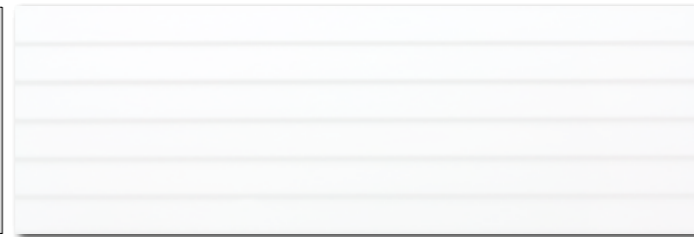

WR1V5000
○ 92 / m²
lesk | glossy | **V2**

WR1V5104
○ 92 / m²
mat | matt | **V2**

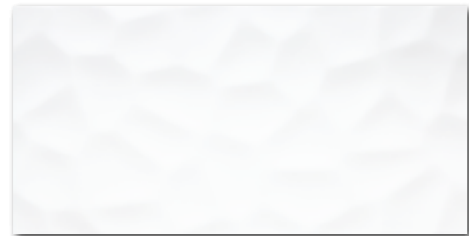

WR2V4000
○ 86 / m²
lesk | glossy | **V2**

WR2V4104
○ 86 / m²
mat | matt | **V2**

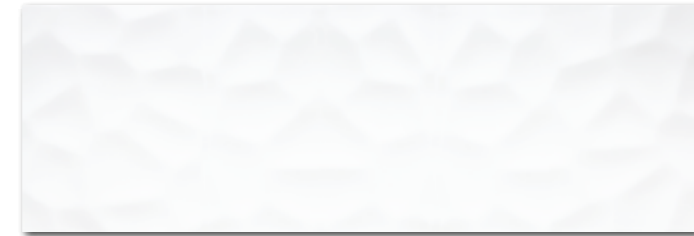

WR2V5000
○ 92 / m²
lesk | glossy | **V2**

WR2V5104
○ 92 / m²
mat | matt | **V2**

news

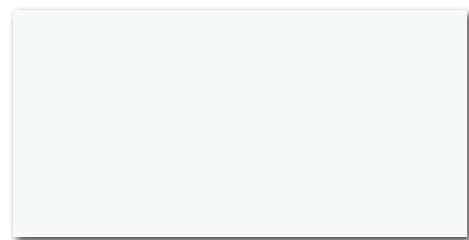

WAAV4000
○ 78 / m²
lesk | glossy

WAAV4104
○ 78 / m²
mat | matt

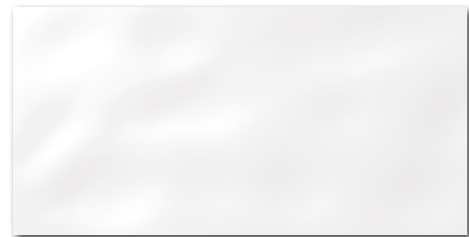

WARV4000
○ 78 / m²
lesk | glossy

WARV4104
○ 78 / m²
mat | matt

bílá / white / biata / белый / fehér / blanco

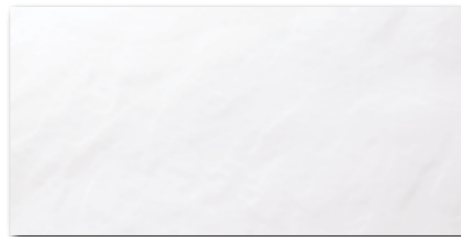

WAGV4000
○ 78 / m²
lesk | glossy

WAGV4104
○ 78 / m²
mat | matt



20x60
V1

25x45
V1

20x40
V1

25x33

20x25



30x60
V1

výrobek / product	cm	mm	EN	ks/m ²	m ²	kg	kg/m ²	brutto kg			
obkládačka / wall tile	30x90	298x898x10,5	EN 14411:2016, annex L BIII GL	4	3,7	1,08	30	32,40	21,7	20,1	677
obkládačka / wall tile	30x60	298x598x10	EN 14411:2016, annex L BIII GL	6	5,56	1,08	40	43,20	20,0	18,5	825
obkládačka / wall tile	20x60	198x598x10	EN 14411:2016, annex L BIII GL	9	8,3	1,08	42	45,36	20,0	18,5	865
obkládačka / wall tile	25x45	250x450x8	EN 14411:2016, annex L BIII GL	13	9	1,50	51	76,50	20,7	13,8	1 081
obkládačka / wall tile	20x40	198x398x7	EN 14411:2016, annex L BIII GL	20	12,5	1,60	48	76,80	20,6	12,9	1 016
obkládačka / wall tile	25x33	250x330x7	EN 14411:2016, annex L BIII GL	18	12	1,50	54	81,00	18,6	12,4	1 030
obkládačka / wall tile	20x25	198x248x6,8	EN 14411:2016, annex L BIII GL	30	20	1,50	60	90,00	17,6	11,7	1 078



podlahy
floors







Všechny výrobky celé série vykazují velké odchylky odstínové difference V3. / All products of the entire batch show big deviations in shade difference V3.

Před pokládkou doporučujeme jednotlivé obkladové prvky vybírat z několika kartonů a výslednou plochu komponovat podle inspirační fotodokumentace z katalogů RAKO případně z webových stránek www.rako.cz.
Žadoucí je kombinace všech jednotlivých designů obkladových prvků včetně jejich natáčení o 180°, aby se dosáhlo optimálního vyváženého vzhledu podlahy nebo stěny.

Before laying the tiles, we suggest you select from several cartons and arrange them as illustrated in the inspiration photo documentation in RAKO catalogues or website www.rako.eu, and mix the tiles to achieve the required result including turning them by 180°.

Przed wyklejeniem zaleca się wyciągnąć płytki z kilku kartonów i rozłożyć na jednej powierzchni. Przy układaniu można się inspirować zdjęciami w katalogu lub na stronach internetowych www.rako.eu. Wskazane jest przekładanie poszczególnych płytek, włącznie z ich obracaniem o 180° aż do osiągnięcia optymalnego wyglądu ściany, czy podłogi.

A burkolólápok lerakása előtt javasoljuk, hogy több kartondobozból rakja ki a burkolólap elemeket és a végleges felületet a RAKO katalógusban található inspiratív fotódokumentáció vagy a www.rako.eu weblapon található képek alapján állítsa össze. Szükséges kombinálni az egyes burkolólap elemeket, illetve azokat 180°-kal is elforgatni az optimális és egyenletes padló- vagy fal felület kialakításához.

Перед укладкой рекомендуется вынуть отдельные элементы плитки из нескольких картонных коробок и составить желаемый рисунок, исходя из разных примеров, указанных на фото в каталогах RAKO или на сайте www.rako.eu. Для достижения оптимального гармоничного вида облицовки стен или плиточного покрытия пола желательно комбинировать отдельные элементы, поворачивая их на 180°.

Antes de la colocación siempre recomendamos desembalar varias cajas y probar a colocar el material en la composición elegida en los catálogos de RAKO en las páginas de internet web www.rako.eu.

Se recomienda la colocación de todos los posibles elementos de la decoración incluso girar los individualmente entre 180°, para conseguir la composición deseada y equilibrada del pavimento o revestimiento.

výrobek / product



	60x60	598x598x10	EN 14411:2016, annex G B1a GL	3	2,8	1,08	32	34,56	24,9	23,0	820
dlaždice / floor tile	60x60	598x598x10	EN 14411:2016, annex G B1a GL	3	2,8	1,08	32	34,56	24,9	23,0	820
dlaždice / floor tile	30x60	298x598x10	EN 14411:2016, annex G B1a GL	6	5,6	1,08	40	43,20	23,2	21,5	954

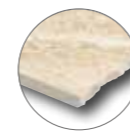

DAR63730
PEI 5 \odot 84 / m²
mat | matt | **R10** | **A**

DAP63730
PEI 5 \odot 86 / m²
lappato | lappato | **R9**



DARSE730
PEI 5 \odot 80 / m²
mat | matt | **R10** | **A**

DAPSE730
PEI 5 \odot 84 / m²
lappato | lappato | **R9**

slonová kost / ivory / kość stoniowa / слоновая кость
elefántcsont / marfil



DAR63731
PEI 5 \odot 84 / m²
mat | matt | **R10** | **A**

DAP63731
PEI 5 \odot 86 / m²
lappato | lappato | **R9**



DARSE731
PEI 5 \odot 80 / m²
mat | matt | **R10** | **A**

DAPSE731
PEI 5 \odot 84 / m²
lappato | lappato | **R9**

běžová / beige / bežowa / бежевый
bézs / beige



DAR63732
PEI 5 \odot 84 / m²
mat | matt | **R10** | **A**

DAP63732
PEI 5 \odot 86 / m²
lappato | lappato | **R9**

hnědo-šedá / brown-grey / brązowoszara
коричневый-серый / szürke-barna / gris-marrón



DAR63733
PEI 4 \odot 84 / m²
mat | matt | **R10** | **A**

DAP63733
PEI 4 \odot 86 / m²
lappato | lappato | **R9**

šedá / grey / szara / серый / szürke / gris



Doporučené skladby formátů viz str. 325. | Recommended combinations of modular sizes see page 325. | Zalecane użożenie modułowych formatów na stronie 325.
Рекомендуемый состав модульных форматов, см. стр. 325. | Composiciones de formatos recomendadas - vea la página n° 325.



30x60
R9
V3



DDPSE730 (SET)
PEI 5 ○ 68 / set
mat/lappato | matt/lappato



DDPSE731 (SET)
PEI 5 ○ 68 / set
mat/lappato | matt/lappato



DDPSE732 (SET)
PEI 5 ○ 68 / set
mat/lappato | matt/lappato



DDPSE733 (SET)
PEI 4 ○ 68 / set
mat/lappato | matt/lappato



30x60
R9
V3

30x30

R10
B
V3



DDM06730 (SET)
PEI 5 ○ 72 / set
mat/lappato | matt/lappato



DDM06731 (SET)
PEI 5 ○ 72 / set
mat/lappato | matt/lappato



DDM06732 (SET)
PEI 5 ○ 72 / set
mat/lappato | matt/lappato



DDM06733 (SET)
PEI 4 ○ 72 / set
mat/lappato | matt/lappato

30x30

R10
B
V3

30x60

R10
A
V3



DCPSE730
PEI 5 ○ 72 / ks
mat | matt



DCPSE731
PEI 5 ○ 72 / ks
mat | matt



DCPSE732
PEI 5 ○ 72 / ks
mat | matt



DCPSE733
PEI 4 ○ 72 / ks
mat | matt

30x60

R10
A
V3

60x9,5

R



DSAS4730
○ 58 / ks
mat | matt



DSAS4731
○ 58 / ks
mat | matt



DSAS4732
○ 58 / ks
mat | matt



DSAS4733
○ 58 / ks
mat | matt

60x9,5

R

60x53

V3
R



DCF65730*
PEI 5 ○ 94 / ks
mat | matt | R10 | A

slonová kost / ivory / kość stoniowa / слонобая кость
elefántcsont / marfil



DCF65731*
PEI 5 ○ 94 / ks
mat | matt | R10 | A

béžová / beige / bežowa / бежевый
bézs / beige



DCF65732*
PEI 5 ○ 94 / ks
mat | matt | R10 | A

hnědo-šedá / brown-grey / brązowoszara
коричневый-серый / szürke-barna / gris-marrón



DCF65733*
PEI 4 ○ 94 / ks
mat | matt | R10 | A

šedá / grey / szara / серый / szürke / gris

60x53

V3
R

výrobek / product



dekor / decor	30x60	298x598x10	EN 14411:2016, annex G B1a GL	4	5,6	0,72	-	-	15,5	21,5	-
mozaika set 30x30 cm / mosaic sheet 30x30 cm	5x5	48x48x10	STO č. 030 - 049913	3	11	0,27	-	-	5,8	21,5	-
schodovka / step tile	30x60	298x598x10	STO č. 030 - 049916	6	5,6	1,08	40	-	23,2	21,5	-
sokl / skirting plinth	60x9,5	598x95x10	STO č. 030 - 049916	13	17,5	0,74	-	-	15,9	21,5	-
schodová tvarovka / special step tile	60x53	598x530x10	STO č. 030 - 049916	2	-	-	-	-	-	-	-

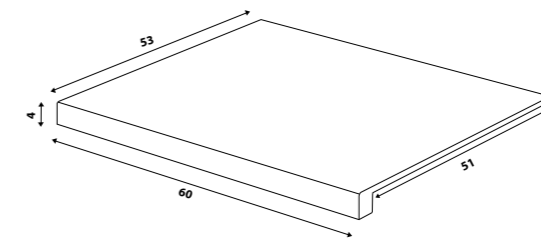

* Výroba na objednávku | Production by order | Produkcja na zamówienie | Производство под заказ | Gyártás rendelésre | Producción bajo demanda

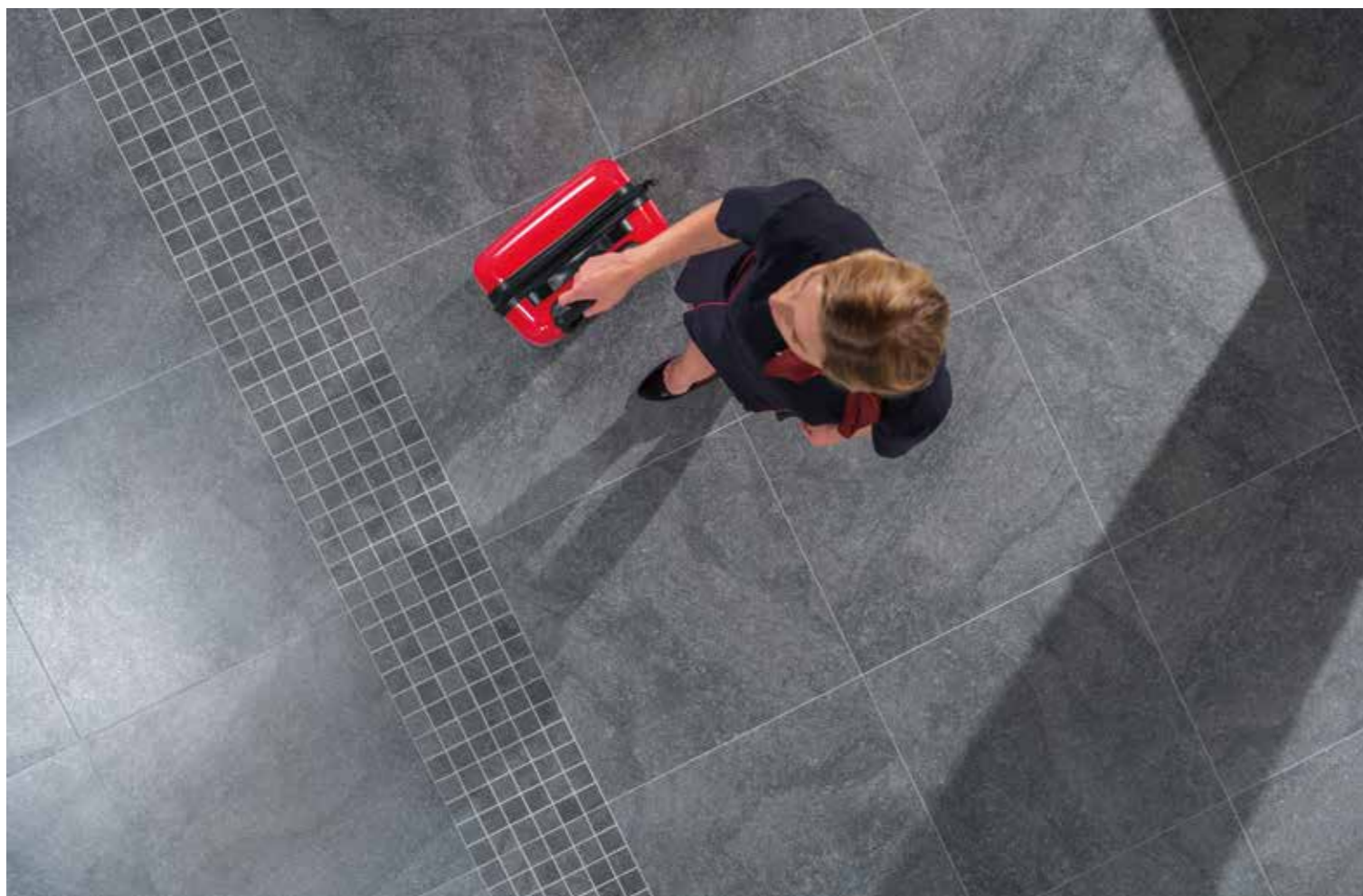

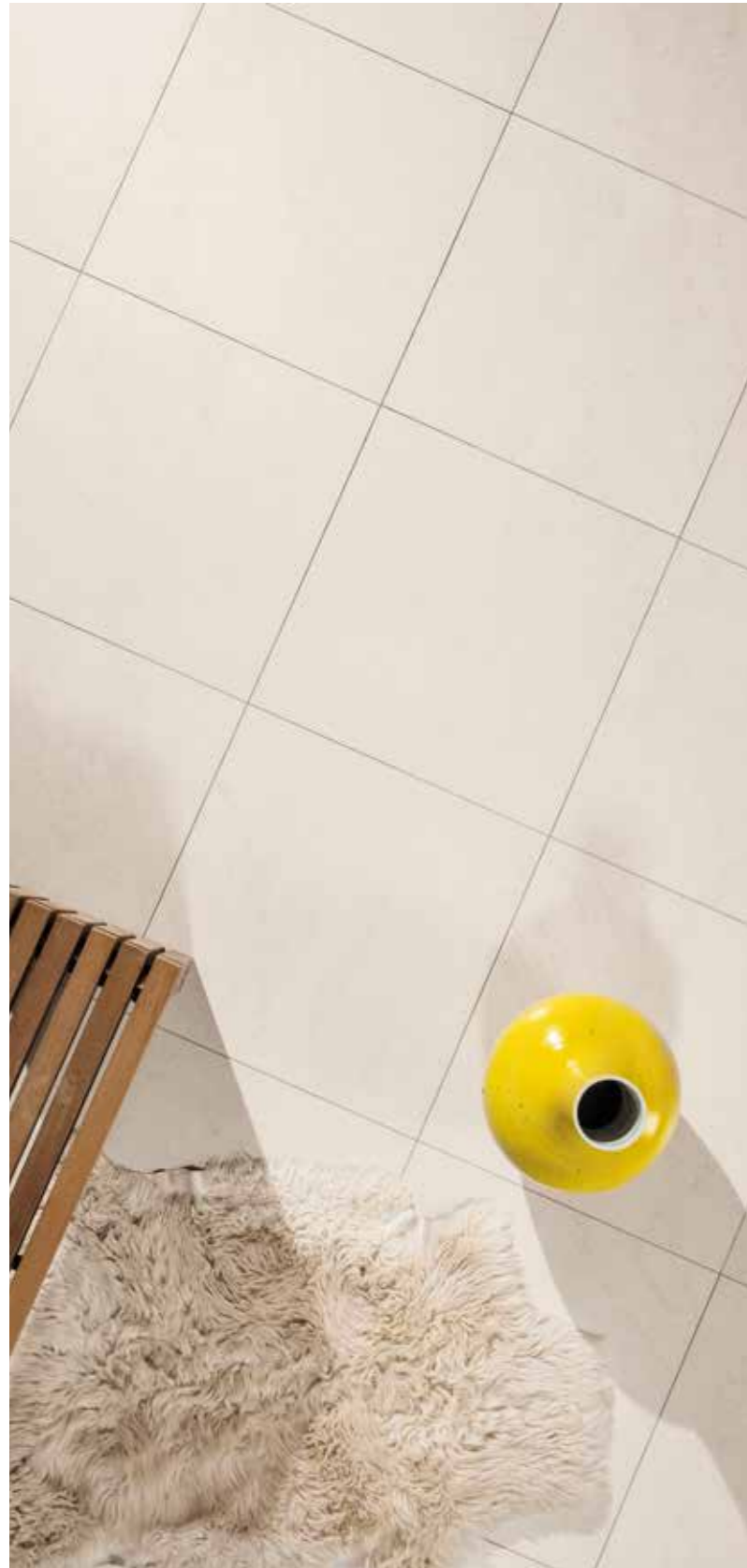

DAK63585
PEI 5 ○ 82 / m²
mat | matt



DAKSE585
PEI 5 ○ 78 / m²
mat | matt

stonová kost / ivory / kość stoniowa
слоновая кость / elefántcsont / marfil



DAK63586
PEI 5 ○ 82 / m²
mat | matt



DAKSE586
PEI 5 ○ 78 / m²
mat | matt

běžová / beige / beżowa / бежевый / bézs / beige



DAK63589
PEI 4 ○ 82 / m²
mat | matt



DAKSE589
PEI 4 ○ 78 / m²
mat | matt

běžovo-šedá / beige-grey / beżowo-szary
бежевый-серый / bézs-szürke / beige-gris



DAK63587
PEI 5 ○ 82 / m²
mat | matt



DAKSE587
PEI 5 ○ 78 / m²
mat | matt

šedá / grey / szara / серый / szürke / gris



DAK63588
PEI 4 ○ 82 / m²
mat | matt



DAKSE588
PEI 4 ○ 78 / m²
mat | matt

černá / black / czarna / черный / fekete / negro

výrobek / product



EN



dlaždice / floor tile	60x60	598x598x10	EN 14411:2016, annex G B1a GL	3	2,8	1,08	32	34,56	24,9	23,0	820
dlaždice / floor tile	30x60	298x598x10	EN 14411:2016, annex G B1a GL	6	5,6	1,08	40	43,20	23,2	21,5	954

Doporučené skladby formátů viz str. 325. | Recommended combinations of modular sizes see page 325. | Zalecane ułożenie modułowych formatów na stronie 325. | Рекомендуемый состав модульных форматов, см. стр. 325. | Composiciones de formatos recomendadas - vea la página n° 325.



30x30
10x10
30x30
45x45

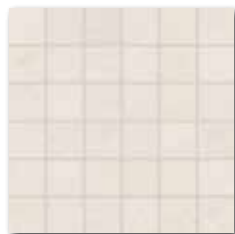

DDM06585 (SET)
PEI 5 \odot 72 / set
mat | matt | **R10** | **B** | \gg | **A**

slonová kost / ivory / kość stoniowa
слоновая кость / elefántcsont / marfil



DAK12585
PEI 5 \odot 90 / m²
mat | matt | **R10** | **B** | \gg | **A**

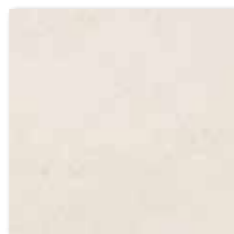

DAA34585
PEI 5 \odot 72 / m²
mat | matt | **R10** | **A**

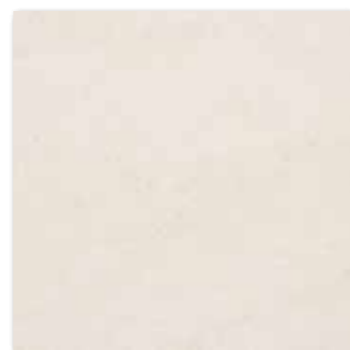

DAK44585
PEI 5 \odot 74 / m²
mat | matt | **R10** | **A** | **A**



DDM06586 (SET)
PEI 5 \odot 72 / set
mat | matt | **R10** | **B** | \gg | **A**

běžová / beige / beżowa / бежевый / bézs / beige



DAK12586
PEI 5 \odot 90 / m²
mat | matt | **R10** | **B** | \gg | **A**



DAA34586
PEI 5 \odot 72 / m²
mat | matt | **R10** | **A**



DAK44586
PEI 5 \odot 74 / m²
mat | matt | **R10** | **A** | **A**



DDM06589 (SET)
PEI 4 \odot 72 / set
mat | matt | **R10** | **B** | \gg | **A**

běžovo-šedá / beige-grey / beżowo-szary
бежевый-серый / bézs-szürke / beige-gris



DAK12589
PEI 4 \odot 90 / m²
mat | matt | **R10** | **B** | \gg | **A**



DAA34589
PEI 4 \odot 72 / m²
mat | matt | **R10** | **A**



DAK44589
PEI 4 \odot 74 / m²
mat | matt | **R10** | **A** | **A**



30x30
10x10
30x30
45x45

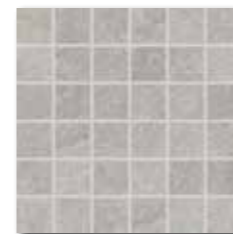

DDM06587 (SET)
PEI 5 \odot 72 / set
mat | matt | **R10** | **B** | \gg | **A**

šedá / grey / szara / серый / szürke / gris



DAK12587
PEI 5 \odot 90 / m²
mat | matt | **R10** | **B** | \gg | **A**



DAA34587
PEI 5 \odot 72 / m²
mat | matt | **R10** | **A**



DAK44587
PEI 5 \odot 74 / m²
mat | matt | **R10** | **A** | **A**

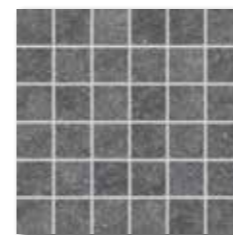

DDM06588 (SET)
PEI 4 \odot 72 / set
mat | matt | **R10** | **B** | \gg | **A**

černá / black / czarna / черный / fekete / negro

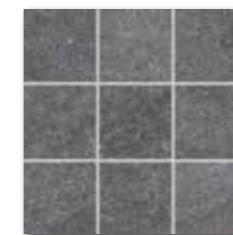

DAK12588
PEI 4 \odot 90 / m²
mat | matt | **R10** | **B** | \gg | **A**



DAA34588
PEI 4 \odot 72 / m²
mat | matt | **R10** | **A**



DAK44588
PEI 4 \odot 74 / m²
mat | matt | **R10** | **A** | **A**



DSAPM585
 \odot 56 / ks
mat | matt
slonová kost / ivory / kość stoniowa
слоновая кость / elefántcsont / marfil



DSAPM586
 \odot 56 / ks
mat | matt
běžová / beige / beżowa / бежевый / bézs / beige



DSAPM589
 \odot 56 / ks
mat | matt
běžovo-šedá / beige-grey / beżowo-szary
бежевый-серый / bézs-szürke / beige-gris



DSAPM587
 \odot 56 / ks
mat | matt
šedá / grey / szara / серый / szürke / gris



DSAPM588
 \odot 56 / ks
mat | matt
černá / black / czarna / черный / fekete / negro

výrobek / product



cm	mm	EN	ks/m ²	m ²	kg	kg/m ²	brutto kg
mozaika set 30x30 cm / mosaic sheet 30x30 cm	5x5	48x48x10	STO č. 030 - 049913	3	11	0,27	-
dlaždice / floor tile	10x10	98x98x10	EN 14411:2016, annex G B1a GL	10	11	0,91	56
dlaždice / floor tile	30x30	298x298x8	EN 14411:2016, annex G B1a GL	13	11	1,18	48
dlaždice / floor tile	45x45	445x445x10	EN 14411:2016, annex G B1a GL	6	5	1,21	26
sohl. / skirting plinth	45x8,5	445x85x10	STO č. 030 - 049916	20	26,1	0,77	-

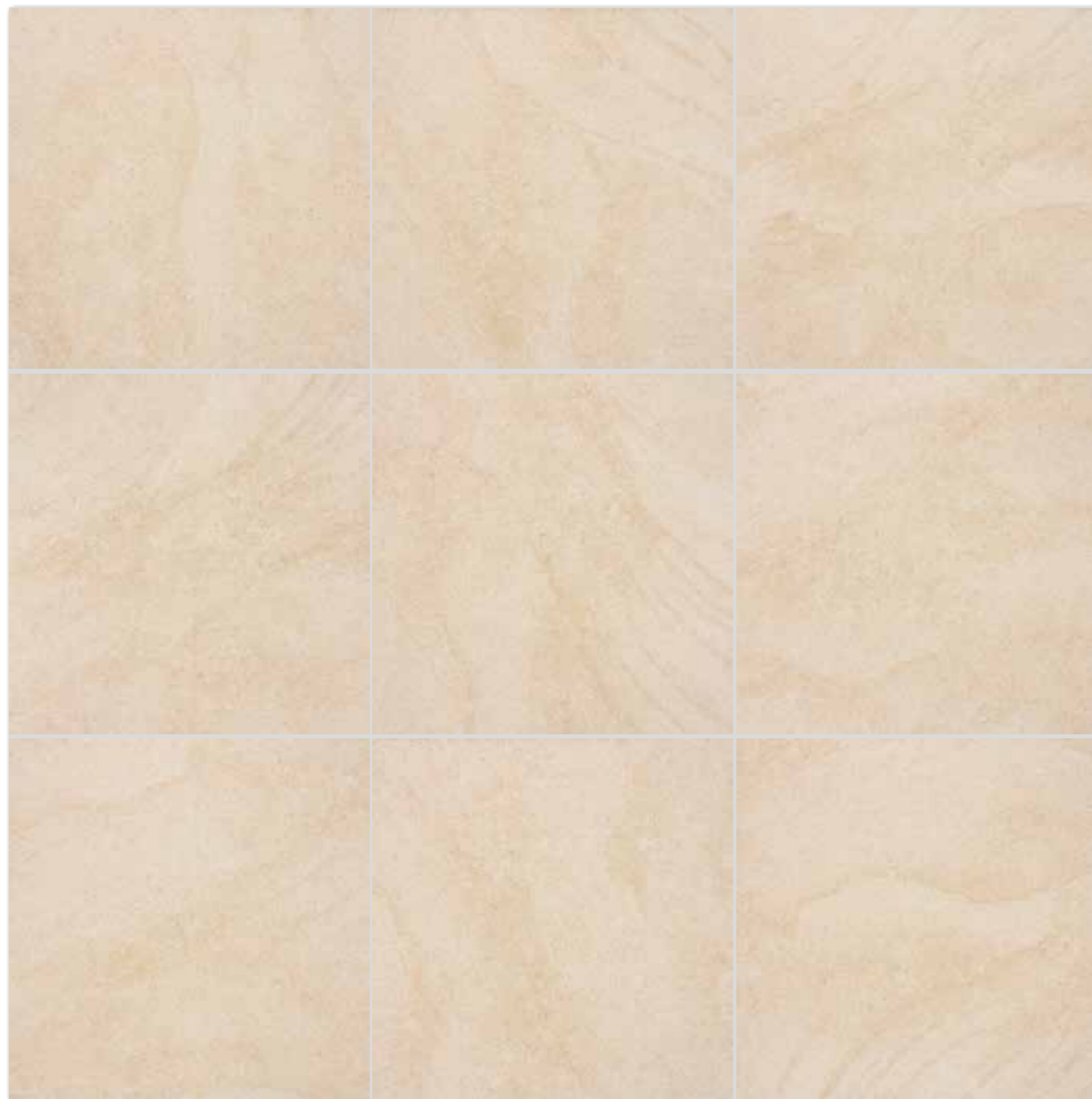

Všechny výrobky celé série vykazují velké odchylky odstínové difference V3. / All products of the entire batch show big deviations in shade difference V3.

Před pokládkou doporučujeme jednotlivé obkladové prvky vybírat z několika kartonů a výslednou plochu komponovat podle inspirativní fotodokumentace z katalogů RAKO případně z webových stránek www.rako.cz

Žádoucí je kombinace všech jednotlivých designů obkladových prvků včetně jejich natáčení o 90° či 180°, aby se dosáhlo optimálního vyváženého vzhledu podlahy nebo stěny.

Before laying the tiles, we suggest you select from several cartons and arrange them as illustrated in the inspiration photo documentation in RAKO catalogues or website www.rako.eu, and mix the tiles to achieve the required result including turning them by 90° or 180°.

Przed wyklejeniem zaleca się wyciągnąć płytki z kilku kartonów i rozłożyć na jednej powierzchni. Przy układaniu można się inspirować zdjęciami w katalogu lub na stronach internetowych www.rako.eu. Wskazane jest przekładanie poszczególnych płytek, włącznie z ich obracaniem o 90° czy 180° aż do osiągnięcia optymalnego wyglądu ściany, czy podłogi.

A burkolólapok lerakása előtt javasoljuk, hogy több kartondobozból rakja ki a burkolólap elemeket és a végleges felületet a RAKO katalógusban található inspiratív fotódokumentáció vagy a www.rako.eu weblapon található képek alapján állítsa össze. Szükséges kombinálni az egyes burkolólap elemeket, illetve azokat 90° vagy 180°-kal is elforgatni az optimális és egyenletes padló- vagy fal felület kialakításához.

Перед укладкой рекомендуется вынуть отдельные элементы плитки из нескольких картонных коробок и составить желаемый рисунок, исходя из разных примеров, указанных на фото в каталогах RAKO или на сайте www.rako.eu. Для достижения оптимального гармоничного вида облицовки стен или плиточного покрытия пола желательно комбинировать отдельные элементы, поворачивая их на 90 - 180°.

Antes de la colocación siempre recomendamos desembalar varias cajas y probar a colocar el material en la composición elegida en los catálogos de RAKO en las páginas de internet www.rako.eu

Se recomienda la colocación de todos los posibles elementos de la decoración incluso girar los individualmente entre sí 90° o 180°, para conseguir la composición deseada y equilibrada del pavimento o revestimiento.

výrobek / product



EN



schodovka / step tile

30x60

298x598x10

STO č. 030 - 049916

6

5,6

1,08

40

-

23,2

21,5

-

sokl / skirting plinth

60x9,5

598x95x10

STO č. 030 - 049916

13

17,5

0,74

-

-

15,9

21,5

-

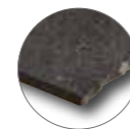

DCPSE585

PEI 5 ○ 72 / ks
mat | mattslonová kost / ivory / kość słoniowa / слоно́вая кость
elefántcsont / marfil

DCPSE586

PEI 5 ○ 72 / ks
mat | matt

béžová / beige / bežowa / бежевый / bézs / beige



DCPSE589

PEI 4 ○ 72 / ks
mat | mattbéžovo-šedá / beige-grey / bežowo-szary
бежевый-серый / bézs-szürke / beige-gris

DSAS4585

○ 58 / ks
mat | mattslonová kost / ivory / kość słoniowa / слоно́вая кость
elefántcsont / marfil

DSAS4586

○ 58 / ks
mat | matt

béžová / beige / bežowa / бежевый / bézs / beige



DSAS4589

○ 58 / ks
mat | mattbéžovo-šedá / beige-grey / bežowo-szary
бежевый-серый / bézs-szürke / beige-gris

DCPSE587

PEI 5 ○ 72 / ks
mat | matt

šedá / grey / szara / серый / szürke / gris



DCPSE588

PEI 4 ○ 72 / ks
mat | matt

černá / black / czarna / черный / fekete / negro

60x9,5



DSAS4587

○ 58 / ks
mat | matt

šedá / grey / szara / серый / szürke / gris



DSAS4588

○ 58 / ks
mat | matt

černá / black / czarna / черный / fekete / negro





DAR81722
PEI 5 ○ 94 / m²
mat | matt

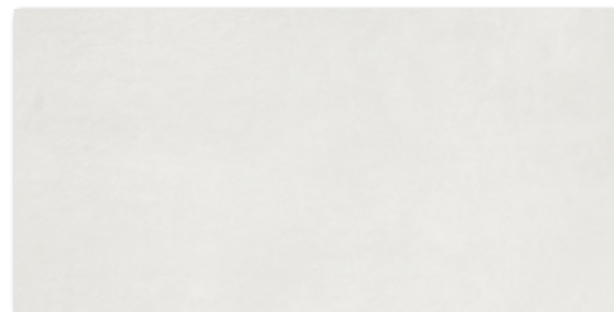

DAR84722
PEI 5 ○ 94 / m²
mat | matt



DCP84722
PEI 5 ○ 78 / ks
mat | matt

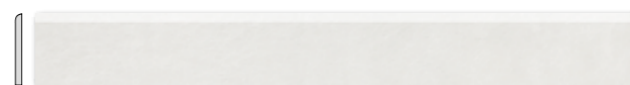

DSA89722
○ 72 / ks
mat | matt

bílá / white / biata / белый / fehér / blanco



DAR81720
PEI 5 ○ 94 / m²
mat | matt



DAR84720
PEI 5 ○ 94 / m²
mat | matt



DCP84720
PEI 5 ○ 78 / ks
mat | matt



DSA89720
○ 72 / ks
mat | matt

slonová kost / ivory / kość sloniowa / слоновая кость
elefántcsont / marfil



DAR81721
PEI 4 ○ 94 / m²
mat | matt



DAR84721
PEI 4 ○ 94 / m²
mat | matt



DCP84721
PEI 4 ○ 78 / ks
mat | matt



DSA89721
○ 72 / ks
mat | matt

hnědo-šedá / brown-grey / brązowoszara / коричневый-серый
szürke-barna / gris-marrón

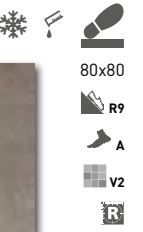

80x80

R9

A

V2

R

40x80

R9

A

V2

R

40x80

R9

A

V2

R

80x9,5

R

výrobek / product



EN



výrobek / product	cm	mm	EN	mm	ks/m ²	kg/m ²	kg	kg	kg	kg	brutto kg
diaždice / floor tile	80x80	798x798x10	EN 14411:2016, annex G Bia GL	2	1,6	1,28	40	51,2	28,0	21,9	1 147
diaždice / floor tile	40x80	398x798x10	EN 14411:2016, annex G Bia GL	4	3,1	1,28	48	61,44	28,0	21,9	1 371
schodovka / step tile	40x80	398x798x10	STO č. 030 - 049916	2	3,1	0,64	-	-	14,1	21,9	-
sokl / skirting plinth	80x9,5	798x95x10	STO č. 030 - 049916	10	13,2	0,76	-	-	16,7	21,9	-

Doporučené skladby formátů viz str. 325. | Recommended combinations of modular sizes see page 325. | Zalecane ułożenie modułowych formatów na stronie 325.
Рекомендуемый состав модульных форматов, см. стр. 325. | Composiciones de formatos recomendadas - vea la página n° 325.

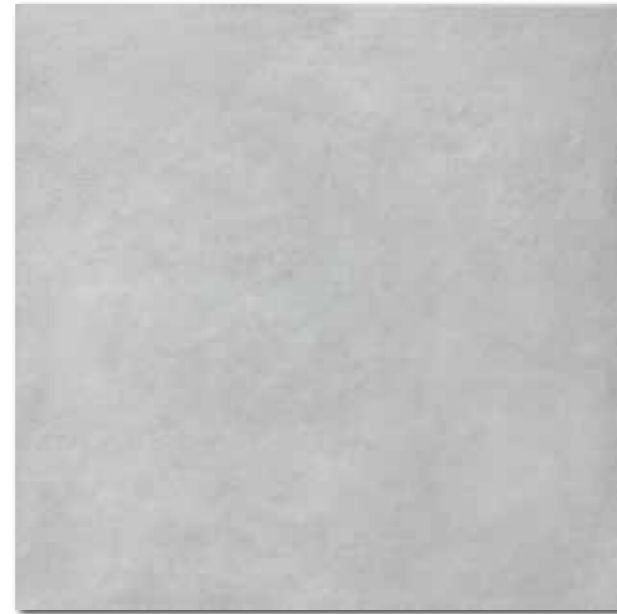

DAR81723
PEI 4 ○ 94 / m²
mat | matt



DAR84723
PEI 4 ○ 94 / m²
mat | matt



DCP84723
PEI 4 ○ 78 / ks
mat | matt



DSA89723
○ 72 / ks
mat | matt
světle šedá / light grey / jasnoszara
светло-серый / világosszürke / gris claro



DAR81724
PEI 4 ○ 94 / m²
mat | matt



DAR84724
PEI 4 ○ 94 / m²
mat | matt



DCP84724
PEI 4 ○ 78 / ks
mat | matt



DSA89724
○ 72 / ks
mat | matt
tmavě šedá / dark grey / ciemnoszara
темно-серый / sötétszürke / gris oscuro

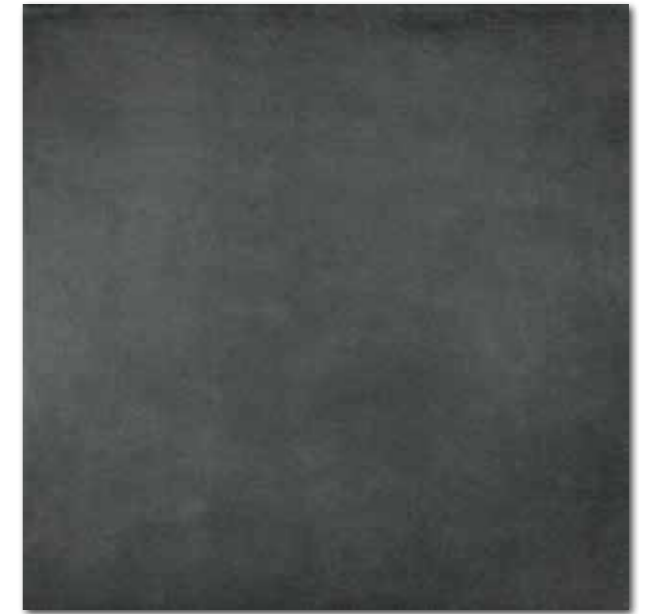

DAR81725
PEI 4 ○ 94 / m²
mat | matt



DAR84725
PEI 4 ○ 94 / m²
mat | matt

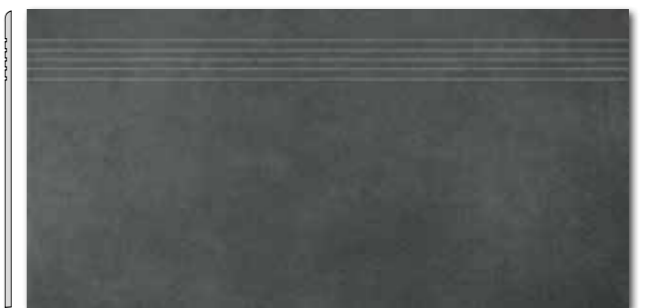

DCP84725
PEI 4 ○ 78 / ks
mat | matt



DSA89725
○ 72 / ks
mat | matt
černá / black / szarna / черный / fekete / negro

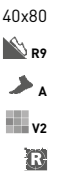
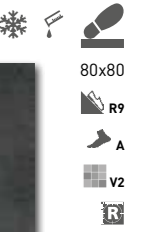

výrobek / product	cm	mm	EN	ks/m ²	m ²	kg	brutto kg				
dlaždice / floor tile	80x80	798x798x10	EN 14411:2016, annex G B1a GL	2	1,6	1,28	40	51,2	28,0	21,9	1 147
dlaždice / floor tile	40x80	398x798x10	EN 14411:2016, annex G B1a GL	4	3,1	1,28	48	61,44	28,0	21,9	1 371
schodovka / step tile	40x80	398x798x10	STO č. 030 - 049916	2	3,1	0,64	-	-	14,1	21,9	-
sokl / skirting plinth	80x9,5	798x95x10	STO č. 030 - 049916	10	13,2	0,76	-	-	16,7	21,9	-

Doporučené skladby formátů viz str. 325. | Recommended combinations of modular sizes see page 325. | Zalecane ułożenie modułowych formatów na stronie 325.
Рекомендуемый состав модульных форматов, см. стр. 325. | Composiciones de formatos recomendadas - vea la página n° 325.

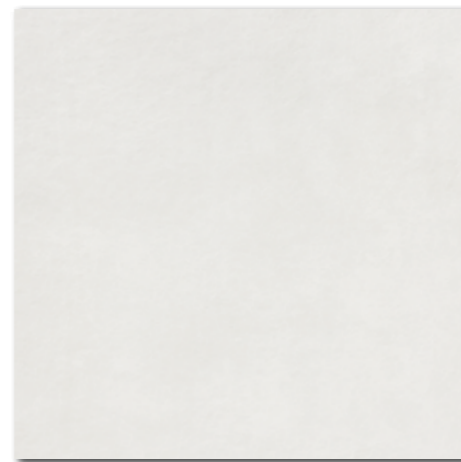

DAR63722
PEI 5 \odot 82 / m²
mat | matt

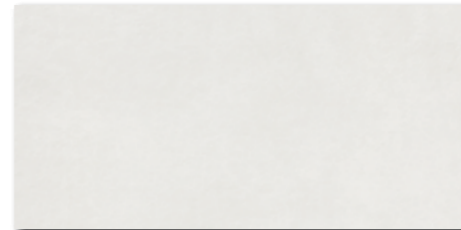

DARSE722
PEI 5 \odot 78 / m²
mat | matt
bílá / white / biata / белый / fehér / blanco



DAR63723
PEI 4 \odot 82 / m²
mat | matt



DARSE723
PEI 4 \odot 78 / m²
mat | matt
světle šedá / light grey / jasnoszara
светло-серый / világosszürke / gris claro



DAR63720
PEI 5 \odot 82 / m²
mat | matt



DARSE720
PEI 5 \odot 78 / m²
mat | matt
slonová kost / ivory / kość słoniowa / слонобая кость
elefántcsont / marfil



DAR63724
PEI 4 \odot 82 / m²
mat | matt



DARSE724
PEI 4 \odot 78 / m²
mat | matt
tmavě šedá / dark grey / ciemnoszara
темно-серый / sötétszürke / gris oscuro



DAR63721
PEI 4 \odot 82 / m²
mat | matt



DARSE721
PEI 4 \odot 78 / m²
mat | matt
hnědo-šedá / brown-grey / brązowoszara / коричневый-серый
szürke-barna / gris-marrón



DAR63725
PEI 4 \odot 82 / m²
mat | matt



DARSE725
PEI 4 \odot 78 / m²
mat | matt
černá / black / czarna / черный / fekete / negro



výrobek / product



dlaždice / floor tile 60x60 598x598x10 EN 14411:2016, annex G Bla GL
dlaždice / floor tile 30x60 298x598x10 EN 14411:2016, annex G Bla GL

3 2,8 1,08 32 34,56 24,9 23,0 820
6 5,6 1,08 40 43,20 23,2 21,5 954

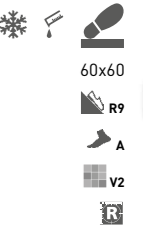

news



news



news



news



news
30x30
10x10
20x20
30x30
45x45



DDM06722 (SET) PEI 5 \odot 72 / set mat | matt | R10 | B | > | A | A
 DAR12722 PEI 5 \odot 90 / m² mat | matt | R10 | B | > | A | A
 DAR26722 PEI 5 \odot 86 / m² mat | matt | R9 | A | A | A
 DAR34722 PEI 5 \odot 72 / m² mat | matt | R9 | A | A
 DAR44722 PEI 5 \odot 74 / m² mat | matt | R9 | A | A

bílá / white / biala / белый / fehér / blanco



DDM06720 (SET) PEI 5 \odot 72 / set mat | matt | R10 | B | > | A | A
 DAR12720 PEI 5 \odot 90 / m² mat | matt | R10 | B | > | A | A
 DAR26720 PEI 5 \odot 86 / m² mat | matt | R9 | A | A | A
 DAR34720 PEI 5 \odot 72 / m² mat | matt | R9 | A | A
 DAR44720 PEI 5 \odot 74 / m² mat | matt | R9 | A | A

slonová kost / ivory / kość stoniowa / слоновая кость
 elefántcsont / marfil



DDM06721 (SET) PEI 4 \odot 72 / set mat | matt | R10 | B | > | A | A
 DAR12721 PEI 4 \odot 90 / m² mat | matt | R10 | B | > | A | A
 DAR26721 PEI 4 \odot 86 / m² mat | matt | R9 | A | A | A
 DAR34721 PEI 4 \odot 72 / m² mat | matt | R9 | A | A
 DAR44721 PEI 4 \odot 74 / m² mat | matt | R9 | A | A

hnědo-šedá / brown-grey / brązowoszara / коричневый-серый
 szürke-barna / gris-marrón



DDM06723 (SET) PEI 4 \odot 72 / set mat | matt | R10 | B | > | A | A
 DAR12723 PEI 4 \odot 90 / m² mat | matt | R10 | B | > | A | A
 DAR26723 PEI 4 \odot 86 / m² mat | matt | R9 | A | A | A
 DAR34723 PEI 4 \odot 72 / m² mat | matt | R9 | A | A
 DAR44723 PEI 4 \odot 74 / m² mat | matt | R9 | A | A

světle šedá / light grey / jasnoszara
 светло-серый / világosszürke / gris claro

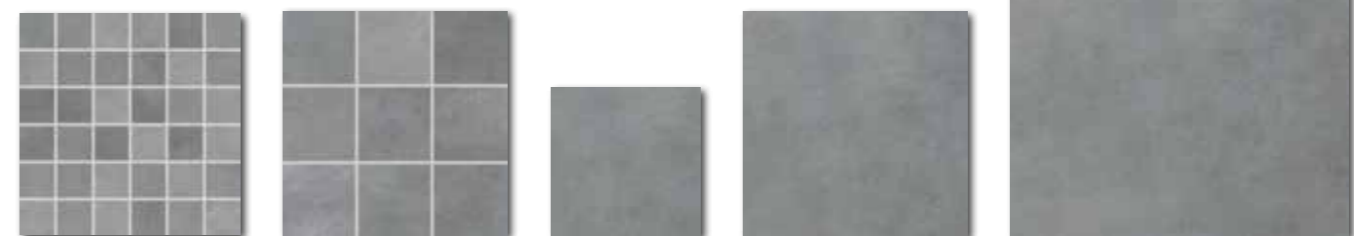

DDM06724 (SET) PEI 4 \odot 72 / set mat | matt | R10 | B | > | A | A
 DAR12724 PEI 4 \odot 90 / m² mat | matt | R10 | B | > | A | A
 DAR26724 PEI 4 \odot 86 / m² mat | matt | R9 | A | A | A
 DAR34724 PEI 4 \odot 72 / m² mat | matt | R9 | A | A
 DAR44724 PEI 4 \odot 74 / m² mat | matt | R9 | A | A

tmavě šedá / dark grey / ciemnoszara
 темно-серый / sötétszürke / gris oscuro

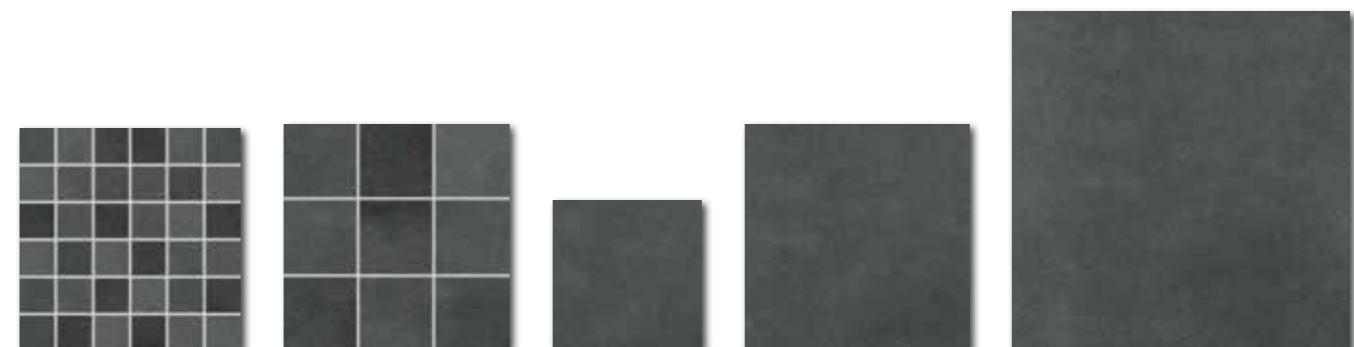

DDM06725 (SET) PEI 4 \odot 72 / set mat | matt | R10 | B | > | A | A
 DAR12725 PEI 4 \odot 90 / m² mat | matt | R10 | B | > | A | A
 DAR26725 PEI 4 \odot 86 / m² mat | matt | R9 | A | A | A
 DAR34725 PEI 4 \odot 72 / m² mat | matt | R9 | A | A
 DAR44725 PEI 4 \odot 74 / m² mat | matt | R9 | A | A

černá / black / czarna / черный / fekete / negro



news
30x30
10x10
20x20
30x30
45x45



výrobek / product



výrobek / product	cm	mm	EN	ks/m ²	m ²	kg/m ²	kg	kg/m ²	brutto kg
mozaika set 30x30 cm / mosaic sheet 30x30 cm	5x5	48x48x10	STO ě. 030 - 049913	3	11	0,27	-	-	5,9
dlaždice / floor tile	10x10	98x98x10	EN 14411:2016, annex G B1a GL	10	11	0,91	56	50,96	19,6
dlaždice / floor tile	20x20	198x198x10	EN 14411:2016, annex G B1a GL	23	25	0,92	57	52,44	21,2
dlaždice / floor tile	30x30	298x298x8	EN 14411:2016, annex G B1a GL	13	11	1,18	48	56,64	21,0
dlaždice / floor tile	45x45	445x445x10	EN 14411:2016, annex G B1a GL	6	5	1,21	26	31,46	25,0

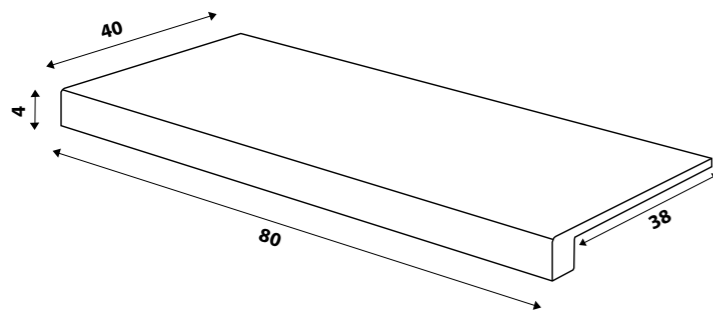
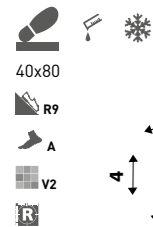

DCF84720* slonová kost / ivory / kość słoniowa / слоно́вая ко́сть / elefántcsont / marfil
 DCF84721* hnědo-šedá / brown-grey / brązowoszara / коричневый-серый / szürke-barna / gris-marrón
 DCF84722* bílá / white / biata / белый / fehér / blanco
 DCF84723* světle šedá / light grey / jasnoszara / светло-серый / világosszürke / gris claro
 DCF84724* tmavě šedá / dark grey / ciemnoszara / темно-серый / sötétszürke / gris oscuro
 DCF84725* černá / black / czarna / черный / fekete / negro
 PEI 4-5 ○ 108 / ks
 mat | matt

45x8,5

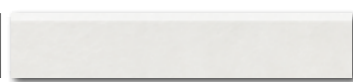

DSAPM722
 ○ 56 / ks
 mat | matt
 bílá / white / biata / белый / fehér / blanco



DSAPM721
 ○ 56 / ks
 mat | matt
 béžová / beige / beżowa / бежевый / bézs / beige



DSAPM724
 ○ 56 / ks
 mat | matt
 tmavě šedá / dark grey / ciemnoszara / темно-серый / sötétszürke / gris oscuro



DSAPM720
 ○ 56 / ks
 mat | matt
 slonová kost / ivory / kość słoniowa / слоно́вая ко́сть / elefántcsont / marfil



DSAPM723
 ○ 56 / ks
 mat | matt
 světle šedá / light grey / jasnoszara / светло-серый / világosszürke / gris claro



DSAPM725
 ○ 56 / ks
 mat | matt
 černá / black / czarna / черный / fekete / negro

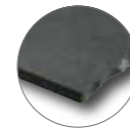

news



DCPSE722
 PEI 5 ○ 72 / ks
 mat | matt
 bílá / white / biata / белый / fehér / blanco

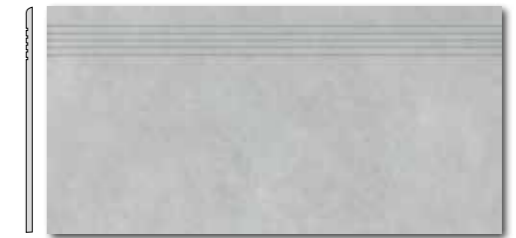

DCPSE723
 PEI 4 ○ 72 / ks
 mat | matt
 světle šedá / light grey / jasnoszara / светло-серый / világosszürke / gris claro



DCPSE720
 PEI 5 ○ 72 / ks
 mat | matt
 slonová kost / ivory / kość słoniowa / слоно́вая ко́сть / elefántcsont / marfil



DCPSE724
 PEI 4 ○ 72 / ks
 mat | matt
 tmavě šedá / dark grey / ciemnoszara / темно-серый / sötétszürke / gris oscuro



DCPSE721
 PEI 4 ○ 72 / ks
 mat | matt
 hnědo-šedá / brown-grey / brązowoszara / коричневый-серый / szürke-barna / gris-marrón



DCPSE725
 PEI 4 ○ 72 / ks
 mat | matt
 černá / black / czarna / черный / fekete / negro

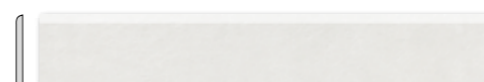

DSAS4722
 ○ 58 / ks
 mat | matt
 bílá / white / biata / белый / fehér / blanco



DSAS4723
 ○ 58 / ks
 mat | matt
 světle šedá / light grey / jasnoszara / светло-серый / világosszürke / gris claro



DSAS4720
 ○ 58 / ks
 mat | matt
 slonová kost / ivory / kość słoniowa / слоно́вая ко́сть / elefántcsont / marfil



DSAS4724
 ○ 58 / ks
 mat | matt
 tmavě šedá / dark grey / ciemnoszara / темно-серый / sötétszürke / gris oscuro



DSAS4721
 ○ 58 / ks
 mat | matt
 hnědo-šedá / brown-grey / brązowoszara / коричневый-серый / szürke-barna / gris-marrón



DSAS4725
 ○ 58 / ks
 mat | matt
 černá / black / czarna / черный / fekete / negro

výrobek / product



výrobek / product	cm	mm	EN	ks/m ²	m ²	m ³	kg	kg/m ²	brutto kg
schodová tvarovka / special step tile	40x80	398x798x10	STO č. 030 - 049916	2	-	-	-	-	-
sokl / skirting plinth	45x8,5	445x85x10	STO č. 030 - 049916	20	26,1	0,77	-	15,9	20,7
schodovka / step tile	30x60	298x598x10	STO č. 030 - 049916	6	5,6	1,08	40	23,2	21,5
sokl / skirting plinth	60x9,5	598x95x10	STO č. 030 - 049916	13	17,5	0,74	-	15,9	21,5

* Výroba na objednávku | Production by order | Produkcja na zamówienie | Производство под заказ | Gyártás rendelésre | Producción bajo demanda



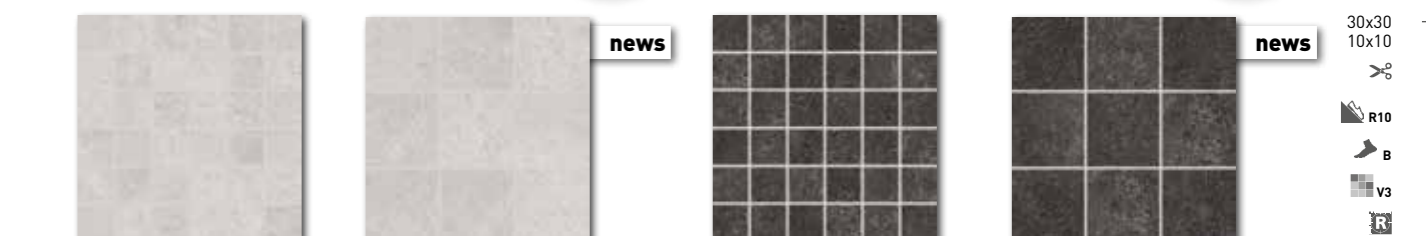
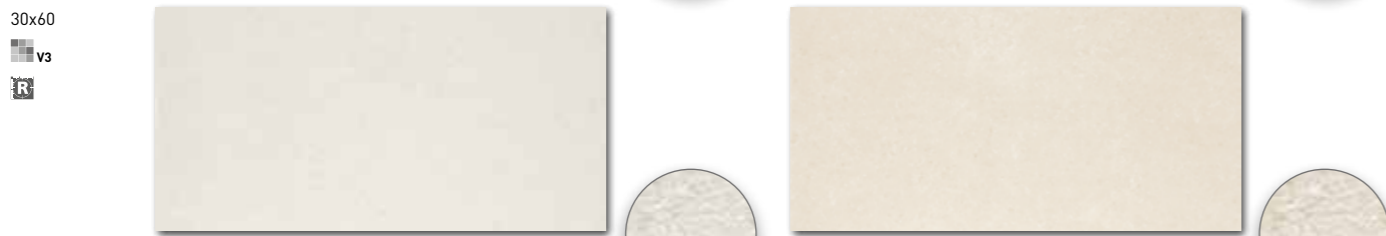
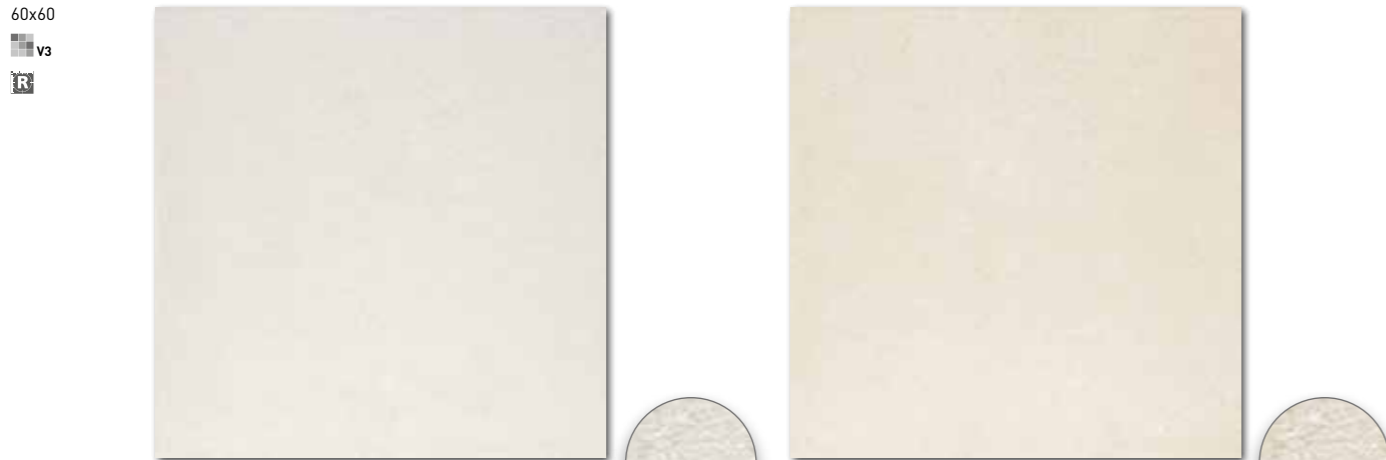

DAK63430 PEI 5 \odot 86 / m² mat | matt | R9 | A

DAR63430 PEI 5 \odot 88 / m² mat | matt | R10 | B

DAK63431 PEI 5 \odot 86 / m² mat | matt | R9 | A

DAR63431 PEI 5 \odot 88 / m² mat | matt | R10 | B

DAK63432 PEI 5 \odot 86 / m² mat | matt | R9 | A

DAR63432 PEI 5 \odot 88 / m² mat | matt | R10 | B

DAK63433 PEI 4 \odot 86 / m² mat | matt | R9 | A

DAR63433 PEI 4 \odot 88 / m² mat | matt | R10 | B

DAKSE430 PEI 5 \odot 82 / m² mat | matt | R9 | A

DARSE430 PEI 5 \odot 84 / m² mat | matt | R10 | B

DAKSE431 PEI 5 \odot 82 / m² mat | matt | R9 | A

DARSE431 PEI 5 \odot 84 / m² mat | matt | R10 | B

DAKSE432 PEI 5 \odot 82 / m² mat | matt | R9 | A

DARSE432 PEI 5 \odot 84 / m² mat | matt | R10 | B

DAKSE433 PEI 4 \odot 82 / m² mat | matt | R9 | A

DARSE433 PEI 4 \odot 84 / m² mat | matt | R10 | B

DDM06430 (SET) PEI 5 \odot 72 / set mat | matt

DAR12430 PEI 5 \odot 90 / m² mat | matt

DDM06431 (SET) PEI 5 \odot 72 / set mat | matt

DAR12431 PEI 5 \odot 90 / m² mat | matt

DDM06432 (SET) PEI 5 \odot 72 / set mat | matt

DAR12432 PEI 5 \odot 90 / m² mat | matt

DDM06433 (SET) PEI 4 \odot 72 / set mat | matt

DAR12433 PEI 4 \odot 90 / m² mat | matt

DCPSE430 PEI 5 \odot 72 / ks mat | matt

DCPSE431 PEI 5 \odot 72 / ks mat | matt

DCPSE432 PEI 5 \odot 72 / ks mat | matt

DCPSE433 PEI 4 \odot 72 / ks mat | matt

DSAS4430 \odot 58 / ks mat | matt
slonová kost / ivory / kość sloniowa
слоновая кость / elefántcsont / marfil

DSAS4431 \odot 58 / ks mat | matt
světle béžová / light beige / jasno-beżowa
светло-бежевый / világosbézs / beige claro

DSAS4432 \odot 58 / ks mat | matt
světle šedá / light grey / jasnoszara
светло-серый / világosszürke / gris claro

DSAS4433 \odot 58 / ks mat | matt
černá / black / czarna / черный / fekete / negro

výrobek / product	mm	mm	EN	ks/m ²	m ²	kg	kg/m ²	brutto kg
dlaždice / floor tile	60x60	598x598x10	EN 14411:2016, annex G Bla GL	3	2,8	1,08	32	34,56
dlaždice / floor tile	30x60	298x598x10	EN 14411:2016, annex G Bla GL	6	5,6	1,08	40	43,20
mozaika set 30x30 cm / mosaic sheet 30x30 cm	5x5	46x46x10	STO č. 030 - 049913	3	11	0,27	-	5,8
dlaždice / floor tile	10x10	98x98x10	EN 14411:2016, annex G Bla GL	10	11	0,91	56	50,96
schodovka / step tile	30x60	298x598x10	STO č. 030 - 049916	6	5,6	1,08	40	23,2
sokl / skirting plinth	60x9,5	598x95x10	STO č. 030 - 049916	13	17,5	0,74	-	15,9

Všechny výrobky celé série vykazují velké odchylky odstínové difference V3. / All products of the entire batch show big deviations in shade difference V3.
 Doporučené skladby formátů viz str. 325. | Recommended combinations of modular sizes see page 325. | Zalecane utożenie modułowych formatów na stronie 325.
 Рекомендуемый состав модульных форматов, см. стр. 325. | Composiciones de formatos recomendadas - vea la página n° 325.





Doporučené skladby formátů viz str. 324. | Recommended combinations of modular sizes see page 324. | Zalecane użożenie modułowych formatów na stronie 324. | Рекомендуемый состав модульных форматов, см. стр. 324. | Composiciones de formatos recomendadas - vea la página nº 324.

Všechny výrobky celé série vykazují velké odchylky odstínové difference V4. / All products of the entire batch show big deviations in shade difference V4.

Před pokládkou doporučujeme jednotlivé obkladové prvky vybírat z několika kartonů a výslednou plochu komponovat podle inspirativní fotodokumentace z katalogů RAKO případně z webových stránek www.rako.cz

Žádoucí je kombinace všech jednotlivých designů obkladových prvků včetně jejich natáčení o 90° či 180°, aby se dosáhlo optimálního vyváženého vzhledu podlahy nebo stěny.

Before laying the tiles, we suggest you select from several cartons and arrange them as illustrated in the inspiration photo documentation in RAKO catalogues or website www.rako.eu, and mix the tiles to achieve the required result including turning them by 90° or 180°.

Przed wyklejeniem zaleca się wyciągnąć płytki z kilku kartonów i rozłożyć na jednej powierzchni. Przy układaniu można się inspirować zdjęciami w katalogu lub na stronach internetowych www.rako.eu. Wskazane jest przekładanie poszczególnych płytek, włącznie z ich obracaniem o 90° czy 180° aż do osiągnięcia optymalnego wyglądu ściany, czy podłogi.

A burkolólápolak lerakása előtt javasoljuk, hogy több kartondobozból rakja ki a burkolólap elemeket és a végleges felületet a RAKO katalógusban található inspiratív fotódokumentáció vagy a www.rako.eu weblapon található képek alapján állítsa össze. Szükséges kombinálni az egyes burkolólap elemeket, illetve azokat 90° vagy 180°-kal is elforgatni az optimális és egyenletes padló- vagy falfelület kialakításához.

Перед укладкой рекомендуется вынуть отдельные элементы плитки из нескольких картонных коробок и составить желаемый рисунок, исходя из разных примеров, указанных на фото в каталогах RAKO или на сайте www.rako.eu. Для достижения оптимального гармоничного вида облицовки стен или плиточного покрытия пола желательно комбинировать отдельные элементы, поворачивая их на 90° - 180°.

Antes de la colocación siempre recomendamos desembalar varias cajas y probar a colocar el material en la composición elegida en los catálogos de RAKO en las páginas de internet web www.rako.eu

Se recomienda la colocación de todos los posibles elementos de la decoración incluso girar los individualmente entre sí 90° o 180°, para conseguir la composición deseada y equilibrada del pavimento o revestimiento.

výrobek / product	15x60	148x598x10	EN	10	11,1	0,90	48	43,2	19,4	21,5	954
dlaždice / floor tile	15x60	148x598x10	EN 14411:2016, annex G B1a GL	10	11,1	0,90	48	43,2	19,4	21,5	954
mozaika set 30x30 cm / mosaic sheet 30x30 cm	5x5	48x48x10	STO č. 030 - 049913	3	11	0,27	-	-	5,8	21,5	-
sokl / skirting plinth	60x7,2	598x72x10	STO č. 030 - 049916	13	23,2	0,56	-	-	12,6	21,5	-



DARSU719
PEI 5 ○ 84 / m²
mat | matt
šedo-bílá / grey-white / szaro-biała
серый и белый / szürke és fehér / blanco-gris



DARSU715
PEI 5 ○ 84 / m²
mat | matt
běžovo-šedá / beige-grey / beżowo-szary
бежевый-серый / bézs-szürke / beige-gris



DARSU716
PEI 4 ○ 84 / m²
mat | matt
běžová / beige / beżowa / бежевый / bézs / beige

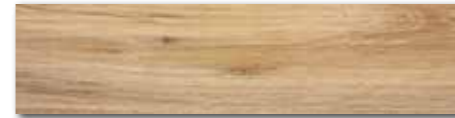

DARSU717
PEI 4 ○ 84 / m²
mat | matt
světle hnědá / light brown / jasnobrazowa
светло-коричневый / világosbarna / marrón claro



DARSU718
PEI 4 ○ 84 / m²
mat | matt
hnědá / brown / brązowa / коричневый / barna / marrón



DDM06719 (SET)
PEI 5 ○ 72 / set
mat | matt



DDM06715 (SET)
PEI 5 ○ 72 / set
mat | matt



DDM06716 (SET)
PEI 4 ○ 72 / set
mat | matt



DDM06717 (SET)
PEI 4 ○ 72 / set
mat | matt



DDM06718 (SET)
PEI 4 ○ 72 / set
mat | matt



DSASP719
○ 58 / ks
mat | matt



DSASP715
○ 58 / ks
mat | matt



DSASP716
○ 58 / ks
mat | matt



DSASP717
○ 58 / ks
mat | matt



DSASP718
○ 58 / ks
mat | matt





Všechny výrobky celé série vykazují velké odchylky odstínové difference V4. / All products of the entire batch show big deviations in shade difference V4.

Před pokládkou doporučujeme jednotlivé obkladové prvky vybírat z několika kartonů a výslednou plochu komponovat podle inspirativní fotodokumentace z katalogů RAKO případně z webových stránek www.rako.cz

Žádoucí je kombinace všech jednotlivých designů obkladových prvků včetně jejich natáčení o 90° či 180°, aby se dosáhlo optimálního vyváženého vzhledu podlahy nebo stěny.

Before laying the tiles, we suggest you select from several cartons and arrange them as illustrated in the inspiration photo documentation in RAKO catalogues or website www.rako.eu, and mix the tiles to achieve the required result including turning them by 90° or 180°.

Przed wyklejeniem zaleca się wyciągnąć płytki z kilku kartonów i rozłożyć na jednej powierzchni. Przy układaniu można się inspirować zdjęciami w katalogu lub na stronach internetowych www.rako.eu. Wskazane jest przekładanie poszczególnych płytek, włącznie z ich obracaniem o 90° czy 180° aż do osiągnięcia optymalnego wyglądu ściany, czy podłogi.

A burkolólapok lerakása előtt javasoljuk, hogy több kartondobozból rakja ki a burkolólap elemeket és a végleges felületet a RAKO katalógusban található inspiratív fotódokumentáció vagy a www.rako.eu weblapon található képek alapján állítsa össze. Szükséges kombinálni az egyes burkolólap elemeket, illetve azokat 90° vagy 180°-kal is elforgatni az optimális és egyenletes padló- vagy falfelület kialakításához.

Перед укладкой рекомендуется вынуть отдельные элементы плитки из нескольких картонных коробок и составить желаемый рисунок, исходя из разных примеров, указанных на фото в каталогах RAKO или на сайте www.rako.eu. Для достижения оптимального гармоничного вида облицовки стен или плиточного покрытия пола желательно комбинировать отдельные элементы, поворачивая их на 90 - 180°.

Antes de la colocación siempre recomendamos desembalar varias cajas y probar a colocar el material en la composición elegida en los catálogos de RAKO en las páginas de internet web www.rako.eu

Se recomienda la colocación de todos los posibles elementos de la decoración incluso girar los individualmente entre sí 90° o 180°, para conseguir la composición deseada y equilibrada del pavimento o revestimiento.

výrobek / product	cm	mm	EN	ks/m ²	m ²	kg	kg/m ²	brutto kg
dlaždice / floor tile	60x60	598x598x10	EN 14411:2016, annex G Bla GL	3	2,8	1,08	32	34,56
dlaždice / floor tile	20x20	198x198x10	EN 14411:2016, annex G Bla GL	23	25	0,92	57	52,44
mozaika set 30x30 cm / mosaic sheet 30x30 cm	5x5	48x48x10	STO č. 030 - 049913	3	11	0,27	-	-



DAK63676
PEI 5 ○ 86 / m²
mat | matt



DAK63677
PEI 5 ○ 86 / m²
mat | matt



DAK26676
PEI 5 ○ 86 / m²
mat | matt | R9 | A



DDM06676 (SET)
PEI 5 ○ 72 / set
mat | matt | R10 | A

světle béžová / light beige / jasnobežová / светло-бежевый
világosbézs / beige claro



DAK26677
PEI 5 ○ 86 / m²
mat | matt | R9 | A



DDM06677 (SET)
PEI 5 ○ 72 / set
mat | matt | R10 | A

hnědá / brown / brązowa / коричневый / barna / marrón



DAK63678
PEI 5 ○ 86 / m²
mat | matt



DAK63679
PEI 5 ○ 86 / m²
mat | matt



DAK26678
PEI 5 ○ 86 / m²
mat | matt | R9 | A

světle šedá / light grey
jasnoszara / светло-серый / világosszürke / gris claro



DDM06678 (SET)
PEI 5 ○ 72 / set
mat | matt | R10 | A



DAK26679
PEI 5 ○ 86 / m²
mat | matt | R9 | A

tmavě šedá / dark grey
ciemnoszara / темно-серый / sötétszürke / gris oscuro



60x60

R9

A

V4

R

20x20

30x30

V4

R

60x60

R9

A

V4

R

20x20

30x30

V4

R



60x60
R9
A
V4
R



DCP63676
PEI 5 ○ 76 / ks
mat | matt



DCP63677
PEI 5 ○ 76 / ks
mat | matt

60x9,5
R



DSAS4676
○ 58 / ks
mat | matt



DSAS4677
○ 58 / ks
mat | matt

60x53
R9
A
V4
R



DCF65676*
PEI 5 ○ 94 / ks
mat | matt
světle béžová / light beige / jasnobežová / светло-бежевый
világosbézs / beige claro



DCF65677*
PEI 5 ○ 94 / ks
mat | matt
hnědá / brown / brązowa / коричневый
barna / marrón



60x60
R9
A
V4
R



DCP63678
PEI 5 ○ 76 / ks
mat | matt

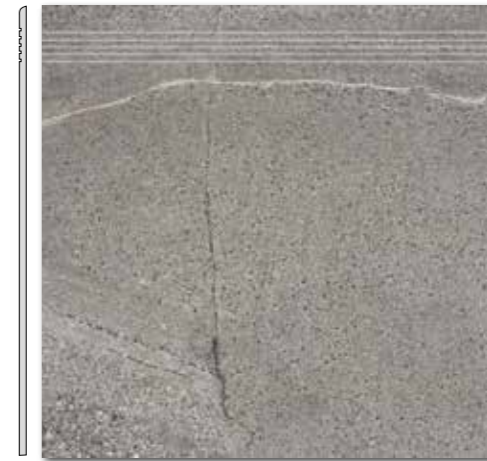

DCP63679
PEI 5 ○ 76 / ks
mat | matt

60x9,5
R



DSAS4678
○ 58 / ks
mat | matt



DSAS4679
○ 58 / ks
mat | matt

60x53
R9
A
V4
R



DCF65678*
PEI 5 ○ 94 / ks
mat | matt
světle šedá / light grey / jasnoszara / светло-серый
világosszürke / gris claro



DCF65679*
PEI 5 ○ 94 / ks
mat | matt
tmavě šedá / dark grey / ciemnoszara / темно-серый
sötétszürke / gris oscuro

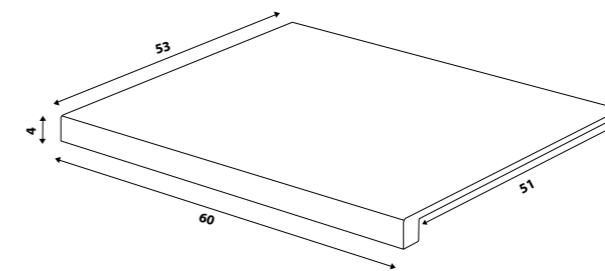

výrobek / product	cm	mm	EN	ks/m ²	m ²	kg	kg/m ²	brutto kg
schodovka / step tile	60x60	598x597x10	STO č. 030 - 049916	3	-	-	-	-
schodová tvarovka / special step tile	60x53	598x530x10	STO č. 030 - 049916	2	-	-	-	-
sokl / skirting plinth	60x9,5	598x95x10	STO č. 030 - 049916	13	17,5	0,74	15,9	21,5

* Výroba na objednávku | Production by order | Produkcja na zamówienie | Производство под заказ | Gyártás rendelésre | Producción bajo demanda

Instalaci schodovky DC***** doporučujeme dvěma způsoby. Samostatně v plném formátu, nebo v dělené podobě tzn. řezáním v místě pokládky na přesný rozměr schodu a navazující podstupnici. Tím je zaručena vzájemná designová návaznost nášlapné plochy a čela schodu.

We recommend two methods of installing install the DC***** stair tiles. Either in full format, or cut to the exact size of the step and the adjacent riser board. This ensures the mutual design continuity of the walking surface and the end of the step.

Montaż płytek schodowych DC***** zalecamy na dwa sposoby. Niezależnie, w pełnym formacie lub docinane, tzn. cięte na miejscu na dokładny wymiar stopnia z uwzględnieniem ułożenia podstopnic. W ten sposób zapewniona będzie zgodność wzoru stopnia i podstopnicy.

A DC***** lépcsőburkolatot kétféle módon javasoljuk lefektetni. Egészben, a teljes formátum felhasználásával, vagy részekre osztva, azaz a lépcső pontos méretére vágva, figyelembe véve a kapcsolódó homloklapot is. Ezáltal dizájn szempontjából biztosított a járófelület és a lépcső homlokfelülete közötti kölcsönös folyamatoság.

Установка лестничной плитки DC***** рекомендуется двумя способами: с использованием полного формата плитки, или путем разрезки на месте укладки по точному размеру ступеньки и подступенка. Это обеспечивает взаимную сочетаемость дизайна покрытия ступеньки и торца ступеньки.

Instalación de peldaños DC***** se recomienda hacer de dos maneras. Por separado en el formato completo o en forma dividida, es decir que el corte se efectúe en el lugar de la instalación a la medida exacta del escalón y de la base. De esta forma se garantiza la continuidad del diseño de la plataforma y la parte frontal del escalón.



30x120
R9
A
V4
R



DAKVF141
PEI 5 ○ 98 / m²
mat | matt



DAKVG141
PEI 5 ○ 98 / m²
mat | matt
světle béžová / light beige / jasno-bežowa / светло-бежевый / világosbézs / beige claro

20x120
R9
A
V4
R



DAKVF142
PEI 4 ○ 98 / m²
mat | matt



DAKVG142
PEI 4 ○ 98 / m²
mat | matt
béžová / beige / bežowa / бежевый / bézs / beige

20x120
R9
A
V4
R



DAKVF143
PEI 4 ○ 98 / m²
mat | matt



DAKVG143
PEI 4 ○ 98 / m²
mat | matt
hnědá / brown / brązowa / коричневый / barna / marrón

30x120
R9
A
V4
R

20x120
R9
A
V4
R



výrobek / product

	mm	mm	EN	ks/m ²	m ²	m ²	kg	kg/m ²	brutto kg	
dlaždice / floor tile	30x120	298x1198x10	EN 14411:2016, annex G Bla GL	3	2,8	1,08	28	30,24	24,0	697
dlaždice / floor tile	20x120	197x1198x10	EN 14411:2016, annex G Bla GL	4	4,2	0,96	33	31,68	21,3	729

Doporučené skladby formátů viz str. 324. | Recommended combinations of modular sizes see page 324. | Zalecane ułożenie modułowych formatów na stronie 324. | Рекомендуемый состав модульных форматов, см. стр. 324. | Composiciones de formatos recomendadas - vea la página n° 324.



30x120
R9
A
V4
R



DAKVF144
PEI 4 ○ 98 / m²
mat | matt

20x120

R9
A
V4
R



DAKVG144
PEI 4 ○ 98 / m²
mat | matt

tmavě hnědá / dark brown / ciemnobrązowa / темно-коричневый / sötétbarna / de color marrón oscuro

30x120

R9
A
V4
R



DAKVF140
PEI 5 ○ 98 / m²
mat | matt

20x120

R9
A
V4
R



DAKVG140
PEI 5 ○ 98 / m²
mat | matt

světle šedá / light grey / jasnoszara / светло-серый / világosszürke / gris claro



20x120
R9
A
V4
R

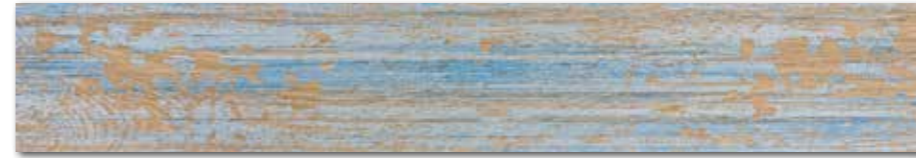

DDTV6467
PEI 4 ○ 102 / ks
mat | matt

běžová-tyrkysová / beige-turquoise / beżowa-turkusowa / бежевый-цвет морской волны / bézs-türkiz / beige-turquesa



DDTV6023
PEI 4 ○ 102 / ks
mat | matt

světle béžová-bílá / light beige-white / jasnobezowa-biała / светло-бежевый-белый / világosbézs-fehér / color beige claro y blanco

30x30

R10
A
V4
R



DDM06141 (SET)
PEI 5 ○ 72 / set
mat | matt

světle béžová / light beige / jasnobezowa / светло-бежевый / világosbézs / beige claro



DDM06142 (SET)
PEI 4 ○ 72 / set
mat | matt

běžová / beige / beżowa / бежевый / bézs / beige

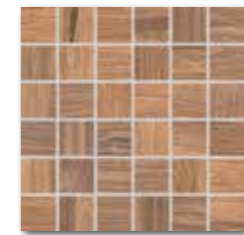

DDM06143 (SET)
PEI 4 ○ 72 / set
mat | matt

hnědá / brown / brązowa / коричневый / barna / marrón



DDM06144 (SET)
PEI 4 ○ 72 / set
mat | matt

tmavě hnědá / dark brown / ciemnobrązowa / темно-коричневый / sötétbarna / de color marrón oscuro



DDM06140 (SET)
PEI 5 ○ 72 / set
mat | matt

světle šedá / light grey / jasnoszara / светло-серый / világosszürke / gris claro



DDM06145 (SET)
PEI 4 ○ 72 / set
mat | matt

vícebarevná / multicoloured / kolorowa / многоцветный / többszínű / multicolor

30x60

R10
A
V4
R



DDPSE023
PEI 4 ○ 90 / ks
mat | matt

vícebarevná / multicoloured / kolorowa / многоцветный / többszínű / multicolor



DDPSE467
PEI 4 ○ 90 / ks
mat | matt

výrobek / product	cm	mm	EN	ks/m ²	m ²	m ³	kg	kg/m ²	brutto kg	
dlaždice / floor tile	30x120	298x119x10	EN 14411:2016, annex G Bla GL	3	2,8	1,08	28	30,24	24,0	697
dlaždice / floor tile	20x120	197x119x10	EN 14411:2016, annex G Bla GL	4	4,2	0,96	33	31,68	21,3	729
mozaika set 30x30 cm / mosaic sheet 30x30 cm	5x5	48x48x10	STO E. 030 - 049913	3	11	0,27	-	-	6,0	-
dekar / decor	20x120	197x119x10	EN 14411:2016, annex G Bla GL	4	4,2	0,96	-	-	21,3	22,2
dekar / decor	30x60	298x598x10	EN 14411:2016, annex G Bla GL	4	5,6	0,72	-	-	16,0	22,2



DSAS4140
 ○ 68 / ks
 mat | matt
 světle šedá / light grey
 jasnoszara / светло-серый / világosszürke / gris claro



DSAS4141
 ○ 68 / ks
 mat | matt
 světle béžová / light beige
 jasno-bežová / светло-бежевый / világosbézs / beige claro



DSAS4142
 ○ 68 / ks
 mat | matt
 béžová / beige / bežová / бежевый / bézs / beige



DSAS4143
 ○ 68 / ks
 mat | matt
 hnědá / brown / brązowa / коричневый / barna / marrón



DSAS4144
 ○ 68 / ks
 mat | matt
 tmavě hnědá / dark brown / ciemnobrązowa / темно-коричневый
 sötétbarna / de color marrón oscuro

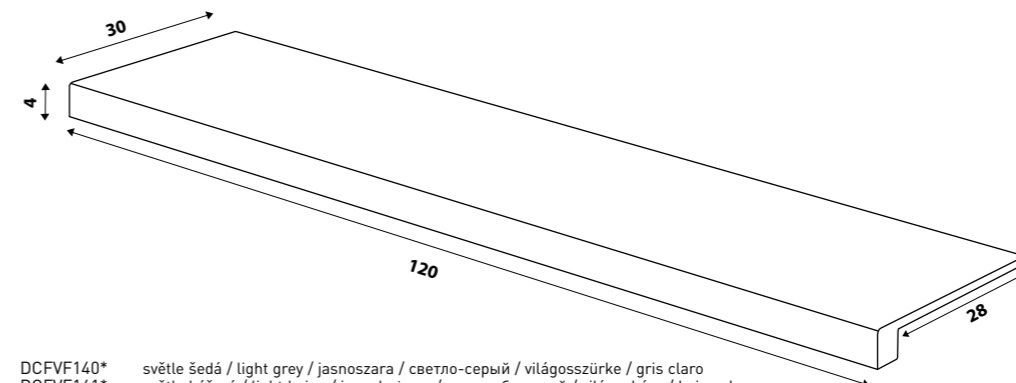

DCFVF140* světle šedá / light grey / jasnoszara / светло-серый / világosszürke / gris claro
DCFVF141* světle béžová / light beige / jasno-bežová / светло-бежевый / világosbézs / beige claro
DCFVF142* béžová / beige / bežová / бежевый / bézs / beige
DCFVF143* hnědá / brown / brązowa / коричневый / barna / marrón
DCFVF144* tmavě hnědá / dark brown / ciemnobrązowa / темно-коричневый / sötétbarna / de color marrón oscuro
 PEI 4-5 ○ 114 / ks
 mat | matt



Všechny výrobky celé série vykazují velké odchylky odstínové difference V4. / All products of the entire batch show big deviations in shade difference V4.

Před pokládkou doporučujeme jednotlivé obkladové prvky vybírat z několika kartonů a výslednou plochu komponovat podle inspirativní fotodokumentace z katalogů RAKO případně z webových stránek www.rako.cz
 Žadoucí je kombinace všech jednotlivých designů obkladových prvků včetně jejich natáčení o 90° či 180°, aby se dosáhlo optimálního vyváženého vzhledu podlahy nebo stěny.

Before laying the tiles, we suggest you select from several cartons and arrange them as illustrated in the inspiration photo documentation in RAKO catalogues or website www.rako.eu, and mix the tiles to achieve the required result including turning them by 90° or 180°.

Przed wyklejeniem zaleca się wyciągnąć płytki z kilku kartonów i rozłożyć na jednej powierzchni. Przy układaniu można się inspirować zdjęciami w katalogu lub na stronach internetowych www.rako.eu. Wskazane jest przekładanie poszczególnych płytek, włącznie z ich obracaniem o 90° czy 180° aż do osiągnięcia optymalnego wyglądu ściany, czy podłogi.

A burkolólápolak lerakása előtt javasoljuk, hogy több kartondobozból rakja ki a burkolólap elemeket és a végleges felületet a RAKO katalógusban található inspiratív fotódokumentáció vagy a www.rako.eu weblapon található képek alapján állítsa össze. Szükséges kombinálni az egyes burkolólap elemeket, illetve azokat 90° vagy 180°-kal is elforgatni az optimális és egyenletes padló- vagy fal felület kialakításához.

Перед укладкой рекомендуется вынуть отдельные элементы плитки из нескольких картонных коробок и составить желаемый рисунок, исходя из разных примеров, указанных на фото в каталогах RAKO или на сайте www.rako.eu. Для достижения оптимального гармоничного вида облицовки стен или плиточного покрытия пола желательно комбинировать отдельные элементы, поворачивая их на 90 - 180°.

Antes de la colocación siempre recomendamos desembalar varias cajas y probar a colocar el material en la composición elegida en los catálogos de RAKO en las páginas de internet www.rako.eu

Se recomienda la colocación de todos los posibles elementos de la decoración incluso girar los individualmente entre sí 90° o 180°, para conseguir la composición deseada y equilibrada del pavimento o revestimiento.

výrobek / product	cm	mm	EN	ks/m ²	m ²	m ²	kg	kg/m ²	brutto kg
schodová tvarovka / special step tile	30x120	298x1198x10	STO č. 030 - 049916	2	-	-	-	-	-
sokl / skirting plinth	60x9,5	598x95x10	STO č. 030 - 049916	13	17,5	0,74	-	15,9	21,5

* Výroba na objednávku | Production by order | Produkcja na zamówienie | Производство под заказ | Gyártás rendelésre | Producción bajo demanda





60x60
R9
A
V2
R

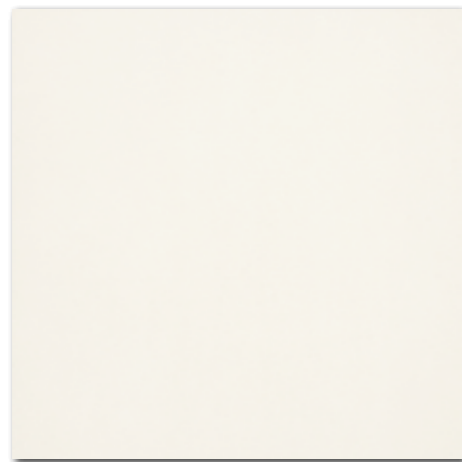

DAK63652
PEI 5 ○ 82 / m²
mat | matt

30x60

R9
A
V2
R

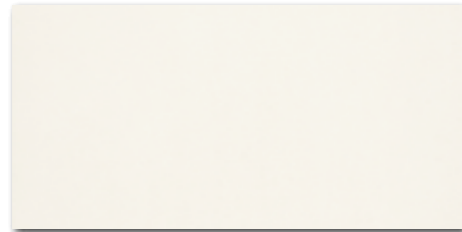

DAKSE652
PEI 5 ○ 78 / m²
mat | matt

slonová kosť / ivory / kość słoniowa
слоновая кость / elefántcsont / marfil

60x60

R9
A
V2
R



DAK63658
PEI 5 ○ 82 / m²
mat | matt

30x60

R9
A
V2
R

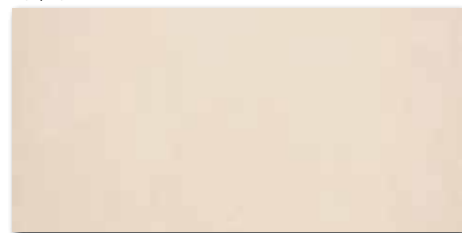

DAKSE658
PEI 5 ○ 78 / m²
mat | matt

světle béžová / light beige / jasnobezowa
светло-бежевый / világosbézs / beige claro



DAK63653
PEI 5 ○ 82 / m²
mat | matt

DAKSE653
PEI 5 ○ 78 / m²
mat | matt

světle šedá / light grey / jasnoszara
светло-серый / világosszürke / gris claro



DAK63654
PEI 5 ○ 82 / m²
mat | matt

DAKSE654
PEI 5 ○ 78 / m²
mat | matt

šedá / grey / szara / серый / szürke / gris



60x60
R9
A
V2
R



DAK63655
PEI 4 ○ 82 / m²
mat | matt

30x60

R9
A
V2
R

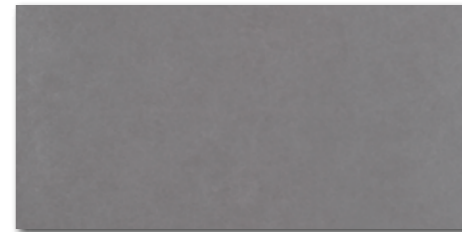

DAKSE655
PEI 4 ○ 78 / m²
mat | matt

tmavě šedá / dark grey / ciemnoszara
темно-серый / sötétszürke / gris oscuro

60x60

R9
A
V2
R



DAK63685
PEI 4 ○ 82 / m²
mat | matt

30x60

R9
A
V2
R

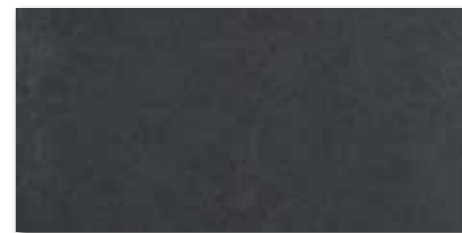

DAKSE685
PEI 4 ○ 78 / m²
mat | matt

černá / black / czarna / черный / fekete / negro

výrobek / product



dlaždice / floor tile	60x60	598x598x10	EN 14411:2016, annex G Bla GL	3	2,8	1,08	32	34,56	24,9	23,0	820
dlaždice / floor tile	30x60	298x598x10	EN 14411:2016, annex G Bla GL	6	5,6	1,08	40	43,20	23,2	21,5	954

Doporučené skladby formátů viz str. 325. | Recommended combinations of modular sizes see page 325. | Zalecane ułożenie modułowych formatów na stronie 325. | Рекомендуемый состав модульных форматов, см. стр. 325. | Composiciones de formatos recomendadas - vea la página n° 325.

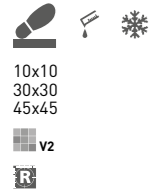

10x10
30x30
45x45



DDM06652 (SET)
PEI 5 \odot 72 / set
mat | matt | **R10** | **B**

slonová kost / ivory / kość słoniowa
слоновая кость / elefántcsont / marfil

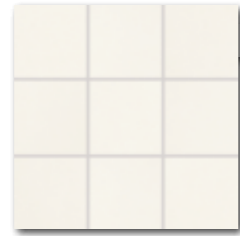

DAK12652 (news)
PEI 5 \odot 90 / m²
mat | matt | **R10** | **B**

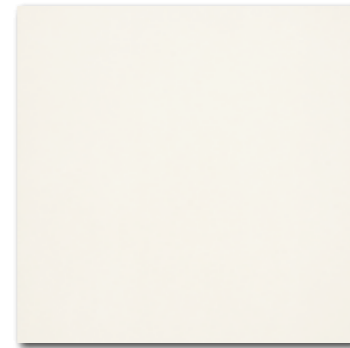

DAK44652
PEI 5 \odot 74 / m²
mat | matt | **R9** | **A**



45x45
R9
A
v2
R



DDM06658 (SET)
PEI 5 \odot 72 / set
mat | matt | **R10** | **B**

světle béžová / light beige / jasnobéžová
светло-бежевый / világosbézs / beige claro



DAK12658 (news)
PEI 5 \odot 90 / m²
mat | matt | **R10** | **B**

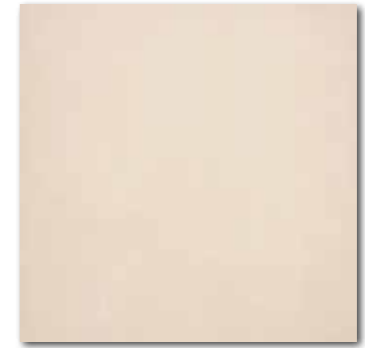

DAK44658
PEI 5 \odot 74 / m²
mat | matt | **R9** | **A**



DDM06653 (SET)
PEI 5 \odot 72 / set
mat | matt | **R10** | **B**

světle šedá / light grey / jasnoszara
светло-серый / világosszürke / gris claro



DAK12653 (news)
PEI 5 \odot 90 / m²
mat | matt | **R10** | **B**

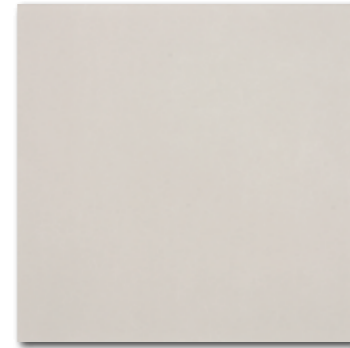

DAK44653
PEI 5 \odot 74 / m²
mat | matt | **R9** | **A**

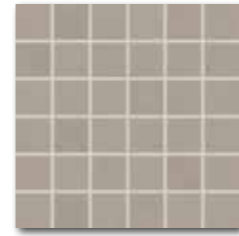

DDM06656 (SET)
PEI 4 \odot 72 / set
mat | matt | **R10** | **B**

béžovo-šedá / beige-grey / beżowo-szary
бежевый-серый / bézs-szürke / beige-gris



DAK12656 (news)
PEI 4 \odot 90 / m²
mat | matt | **R10** | **B**



DAK44656
PEI 4 \odot 74 / m²
mat | matt | **R9** | **A**

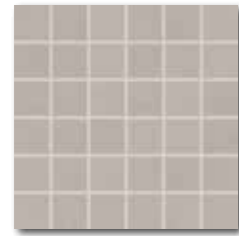

DDM06654 (SET)
PEI 5 \odot 72 / set
mat | matt | **R10** | **B**

šedá / grey / szara / серый / szürke / gris



DAK12654 (news)
PEI 5 \odot 90 / m²
mat | matt | **R10** | **B**



DAK44654
PEI 5 \odot 74 / m²
mat | matt | **R9** | **A**

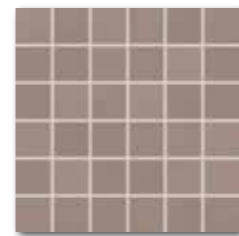

DDM06657 (SET)
PEI 4 \odot 72 / set
mat | matt | **R10** | **B**

hnědo-šedá / brown-grey / brązowoszara
коричневый-серый / szürke-barna
gris-marrón

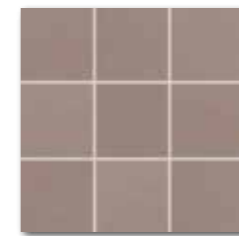

DAK12657 (news)
PEI 4 \odot 90 / m²
mat | matt | **R10** | **B**



DAK44657
PEI 4 \odot 74 / m²
mat | matt | **R9** | **A**

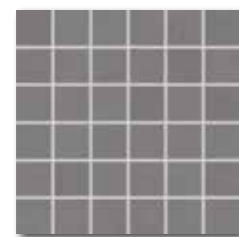

DDM06655 (SET)
PEI 4 \odot 72 / set
mat | matt | **R10** | **B**

tmavě šedá / dark grey / ciemnoszara
темно-серый / sötétszürke / gris oscuro

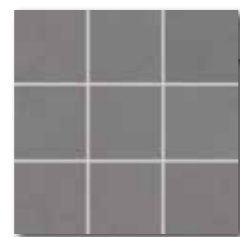

DAK12655 (news)
PEI 4 \odot 90 / m²
mat | matt | **R10** | **B**



DAK44655
PEI 4 \odot 74 / m²
mat | matt | **R9** | **A**



DDM06685 (SET)
PEI 4 \odot 72 / set
mat | matt | **R10** | **B**

černá / black / czarna / черный
fekete / negro



DAK12685 (news)
PEI 4 \odot 90 / m²
mat | matt | **R10** | **B**



DAK44685
PEI 4 \odot 74 / m²
mat | matt | **R9** | **A**

výrobek / product



výrobek / product	L	W	EN	mm	kg/m ²	m ²	m ²	kg	kg/m ²	brutto kg
mozaika set 30x30 cm / mosaic sheet 30x30 cm	5x5	48x48x10	STO E. 030 - 049913	3	11	0,27	-	5,8	21,5	-
dlaždice / floor tile	10x10	98x98x10	EN 14411:2016, annex G B1a GL	10	11	0,91	56	50,96	19,6	1 121
dlaždice / floor tile	45x45	445x445x10	EN 14411:2016, annex G B1a GL	6	5	1,21	26	31,46	25,0	677



30x60

R9

A

V2

R

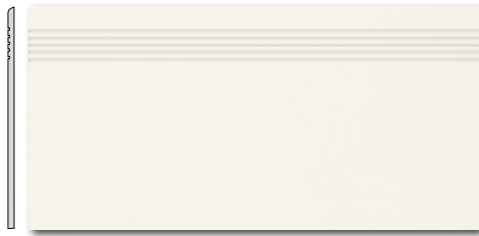

DCPSE652
PEI 5 ○ 72 / ks
mat | matt

60x9,5

R

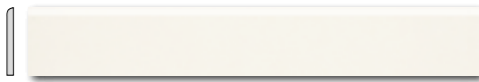

DSAS4652
○ 58 / ks
mat | matt

45x8,5

R

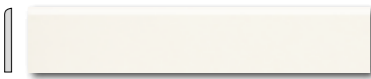

DSAPM652
○ 56 / ks
mat | matt

slonová kost / ivory / kość stoniowa
слоновая кость / elefántcsont / marfil



30x60

R9

A

V2

R



DCPSE654
PEI 5 ○ 72 / ks
mat | matt



DSAS4654
○ 58 / ks
mat | matt



DSAPM654
○ 56 / ks
mat | matt

šedá / grey / szara / серый / szürke / gris



DCPSE657
PEI 4 ○ 72 / ks
mat | matt



DSAS4657
○ 58 / ks
mat | matt



DSAPM657
○ 56 / ks
mat | matt

hnědo-šedá / brown-grey / brązowoszara / коричневый-серый
szürke-barna / gris-marrón

30x60

R9

A

V2

R



DCPSE653
PEI 5 ○ 72 / ks
mat | matt

60x9,5

R

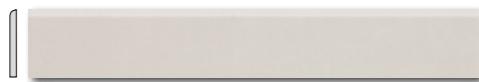

DSAS4653
○ 58 / ks
mat | matt

45x8,5

R



DSAPM653
○ 56 / ks
mat | matt

světle šedá / light grey / jasnoszara
светло-серый / világosszürke / gris claro



DCPSE656
PEI 4 ○ 72 / ks
mat | matt

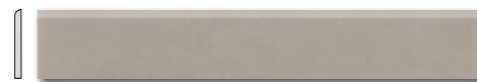

DSAS4656
○ 58 / ks
mat | matt



DSAPM656
○ 56 / ks
mat | matt

běžovo-šedá / beige-grey / beżowo-szary
бежевый-серый / bézs-szürke / beige-gris



DCPSE655
PEI 4 ○ 72 / ks
mat | matt



DSAS4655
○ 58 / ks
mat | matt



DSAPM655
○ 56 / ks
mat | matt

tmavě šedá / dark grey / ciemnoszara
темно-серый / sötétszürke / gris oscuro



DCPSE685
PEI 4 ○ 72 / ks
mat | matt



DSAS4685
○ 58 / ks
mat | matt



DSAPM685
○ 56 / ks
mat | matt

černá / black / czarna / черный / fekete / negro

výrobek / product



EN



ks/m²

m²



kg/m²

brutto kg

výrobek / product	cm	mm	EN	mm	ks/m ²	m ²	kg	kg/m ²	brutto kg	
schodovka / step tile	30x60	298x598x10	STO ě. 030 - 049916	6	5,6	1,08	40	-	23,2	21,5
sokl / skirting plinth	60x9,5	598x95x10	STO ě. 030 - 049916	13	17,5	0,74	-	-	15,9	21,5
sokl / skirting plinth	45x8,5	445x85x10	STO ě. 030 - 049916	20	26,1	0,77	-	-	15,9	20,7
mozaika set 30x30 cm / mosaic sheet 30x30 cm	2,5x2,5	23x23x10	STO ě. 030 - 049913	3	11	0,27	-	-	5,8	21,5
dekar / decar	30x60	298x598x10	EN 14411:2016, annex G B1a GL	4	5,6	0,72	-	-	15,5	21,5



DDM0U001 (SET)

PEI 4 ○ 82 / set
mat | matt | R10 | B

vícebarevná / multicoloured / kolorowa
многочетный / többszínű / multicolor



DDPSE001 (SET)

PEI 4 ○ 78 / set
mat | matt | R10 | A

30x30

30x60

V4

R

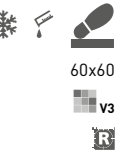

DAK63668
PEI 5 \odot 86 / m²
mat | matt | **R10** | **A**



DAP63668
PEI 5 \odot 88 / m²
lappato | lappato | **R9**



DAK63669
PEI 5 \odot 86 / m²
mat | matt | **R10** | **A**

DAP63669
PEI 5 \odot 88 / m²
lappato | lappato | **R9**



DAKSE668
PEI 5 \odot 80 / m²
mat | matt | **R10** | **A**



DAPSE668
PEI 5 \odot 84 / m²
lappato | lappato | **R9**



DAKSE669
PEI 5 \odot 86 / m²
mat | matt | **R10** | **A**

DAPSE669
PEI 5 \odot 84 / m²
lappato | lappato | **R9**



DAR63668
PEI 5 \odot 88 / m²
mat | matt



DAP63669
PEI 5 \odot 88 / m²
mat | matt



DARSE668
PEI 5 \odot 84 / m²
mat | matt | **R10** | **B**

běžová / beige / beżowa / бежевый / bézs / beige



DAGSE668*
PEI 5 \odot 86 / m²
mat | matt | **R11** | **C**



DARSE669
PEI 5 \odot 86 / m²
mat | matt | **R10** | **B**

hnědá / brown / brązowa / коричневый / barna / marrón



Doporučené skladby formátů viz str. 325. | Recommended combinations of modular sizes see page 325. | Zalecane ułożenie modułowych formatów na stronie 325. | Рекомендуемый состав модульных форматов, см. стр. 325. | Composiciones de formatos recomendadas - vea la página nº 325.

* Výroba na objednávku | Production by order | Produkcja na zamówienie | Производство под заказ | Gyartás rendelésre | Producción bajo demanda



Všetchny výrobky celé série vykazují velké odchylky odstínové difference V3. / All products of the entire batch show big deviations in shade difference V3.

Před pokládkou doporučujeme jednotlivé obkladové prvky vybírat z několika kartonů a výslednou plochu komponovat podle inspirativní fotodokumentace z katalogů RAKO případně z webových stránek www.rako.cz

Žadoucí je kombinace všech jednotlivých designů obkladových prvků včetně jejich natáčení o 90° či 180°, aby se dosáhlo optimálního vyváženého vzhledu podlahy nebo stěny.

Before laying the tiles, we suggest you select from several cartons and arrange them as illustrated in the inspiration photo documentation in RAKO catalogues or website www.rako.eu, and mix the tiles to achieve the required result including turning them by 90° or 180°.

Przed wyklejeniem zaleca się wyciągnąć płytki z kilku kartonów i rozłożyć na jednej powierzchni. Przy układaniu można się inspirować zdjęciami w katalogu lub na stronach internetowych www.rako.eu. Wskazane jest przekładanie poszczególnych płytek, włącznie z ich obracaniem o 90° czy 180° aż do osiągnięcia optymalnego wyglądu ściany, czy podłogi.

A burkolólapok lerakása előtt javasoljuk, hogy több kartondobozból rakja ki a burkolólap elemeket és a végleges felületet a RAKO katalógusban található inspiratív fotódokumentáció vagy a www.rako.eu weblapon található képek alapján állítsa össze. Szükséges kombinálni az egyes burkolólap elemeket, illetve azokat 90° vagy 180°-kal is elforgatni az optimális és egyenletes padló- vagy falfelület kialakításához.

Перед укладкой рекомендуется вынуть отдельные элементы плитки из нескольких картонных коробок и составить желаемый рисунок, исходя из разных примеров, указанных на фото в каталогах RAKO или на сайте www.rako.eu. Для достижения оптимального гармоничного вида облицовки стен или плиточного покрытия пола желательно комбинировать отдельные элементы, поворачивая их на 90 - 180°.

Antes de la colocación siempre recomendamos desembalar varias cajas y probar a colocar el material en la composición elegida en los catálogos de RAKO en las páginas de internet web www.rako.eu

Se recomienda la colocación de todos los posibles elementos de la decoración incluso girar los individualmente entre sí 90° o 180°, para conseguir la composición deseada y equilibrada del pavimento o revestimiento.



DAK63666
PEI 5 \odot 86 / m²
mat | matt | **R10** | **A**

DAP63666
PEI 5 \odot 88 / m²
lappato | lappato | **R9**



DAK63667
PEI 5 \odot 86 / m²
mat | matt | **R10** | **A**

DAP63667
PEI 5 \odot 88 / m²
lappato | lappato | **R9**



DAKSE666
PEI 5 \odot 80 / m²
mat | matt | **R10** | **A**

DAPSE666
PEI 5 \odot 84 / m²
lappato | lappato | **R9**

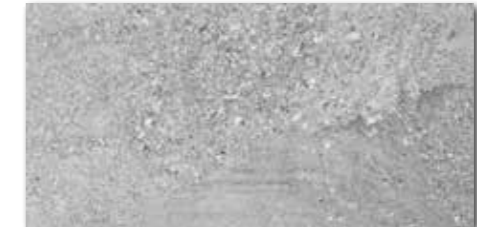

DAKSE667
PEI 5 \odot 86 / m²
mat | matt | **R10** | **A**

DAPSE667
PEI 5 \odot 84 / m²
lappato | lappato | **R9**



DAR63666
PEI 5 \odot 88 / m²
mat | matt

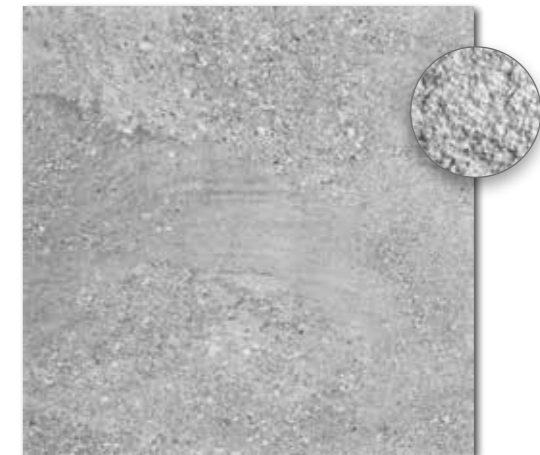

DAR63667
PEI 5 \odot 88 / m²
mat | matt



DARSE666
PEI 5 \odot 84 / m²
mat | matt | **R10** | **B**

světle šedá / light grey / jasnoszara
светло-серый / világosszürke / gris claro

DAGSE666*
PEI 5 \odot 86 / m²
mat | matt | **R11** | **C**



DARSE667
PEI 5 \odot 86 / m²
mat | matt | **R10** | **B**

šedá / grey / szara / серый / szürke / gris

DAGSE667*
PEI 5 \odot 86 / m²
mat | matt | **R11** | **C**

výrobek / product



	L	W	EN	T	kg/m ²	kg/m ²	kg/m ²	kg/m ²	kg/m ²	kg/m ²	kg/m ²
dlaždice / floor tile	60x60	598x598x10	EN 14411:2016, annex G B1a GL	3	2,8	1,08	32	34,56	24,9	23,0	820
dlaždice / floor tile	30x60	298x598x10	EN 14411:2016, annex G B1a GL	6	5,6	1,08	40	43,20	23,2	21,5	954

* Výroba na objednávku | Production by order | Produkcja na zamówienie | Производство под заказ | Gyártás rendelésre | Producción bajo demanda



60x60
v3
R

30x60
v3
R

60x60
R10
B
v3
R

30x60
v3
R



30x60
R10
B
V3
R



DDPSE666 (SET)
PEI 5 ○ 78 / set
mat/lappato | matt/lappato



DDPSE667 (SET)
PEI 5 ○ 78 / set
mat/lappato | matt/lappato



30x60
R10
B
V3
R



DDPSE668 (SET)
PEI 5 ○ 78 / set
mat/lappato | matt/lappato



DDPSE669 (SET)
PEI 5 ○ 78 / set
mat/lappato | matt/lappato

30x30
R10
B
V3
R



DDM0666 (SET)
PEI 5 ○ 72 / set
mat/lappato | matt/lappato

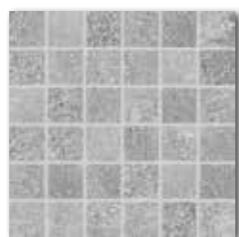

DDM0667 (SET)
PEI 5 ○ 72 / set
mat/lappato | matt/lappato

30x30
R10
B
V3
R



DDM0668 (SET)
PEI 5 ○ 72 / set
mat/lappato | matt/lappato



DDM0669 (SET)
PEI 5 ○ 72 / set
mat/lappato | matt/lappato

30x60
R10
A
V3
R



DCPSE666
PEI 5 ○ 72 / ks
mat | matt



DCPSE667
PEI 5 ○ 72 / ks
mat | matt



DCPSE668
PEI 5 ○ 72 / ks
mat | matt



DCPSE669
PEI 5 ○ 72 / ks
mat | matt

60x9,5
R



DSAS4666
○ 58 / ks
mat | matt



DSKS4666
○ 58 / ks
lappato | lappato



DSAS4667
○ 58 / ks
mat | matt



DSKS4667
○ 58 / ks
lappato | lappato



DSAS4668
○ 58 / ks
mat | matt



DSKS4668
○ 58 / ks
lappato | lappato



DSAS4669
○ 58 / ks
mat | matt



DSKS4669
○ 58 / ks
lappato | lappato

30x60
V3
R



DCFSE666*
PEI 5 ○ 92 / ks
mat | matt | R10 | A

světle šedá / light grey / jasnoszara
светло-серый / világosszürke / gris claro



DCFSE667*
PEI 5 ○ 92 / ks
mat | matt | R10 | A

šedá / grey / szara / серый / szürke / gris



DCFSE668*
PEI 5 ○ 92 / ks
mat | matt | R10 | A

béžová / beige / beżowa / бежевый / bézs / beige



DCFSE669*
PEI 5 ○ 92 / ks
mat | matt | R10 | A

hnědá / brown / brązowa / коричневый / barna / marrón

výrobek / product



dekor / decor	cm	mm	EN	ks/m ²	m ²	kg	brutto kg
dekor / decor	30x60	298x598x10	EN 14411:2016, annex G B1a GL	4	5,6	0,72	15,5
mozaika set 30x30 cm / mosaic sheet 30x30 cm	5x5	48x48x10	STO č. 030 - 049913	3	11	0,27	5,8
schodovka / step tile	30x60	298x598x10	STO č. 030 - 049916	6	5,6	1,08	23,2
sokl / skirting plinth	60x9,5	598x95x10	STO č. 030 - 049916	13	17,5	0,74	15,9
schodová tvarovka / special step tile	30x60	298x598x10	STO č. 030 - 049916	2	-	-	-

* Výroba na objednávku | Production by order | Produkcja na zamówienie | Производство под заказ | Gyártás rendelésre | Producción bajo demanda

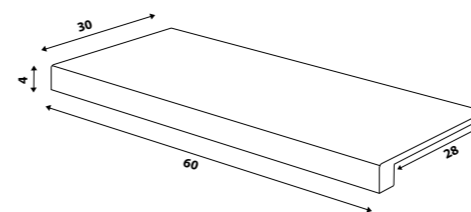

30x60
R10
B
V3
R

30x30
R10
B
V3
R

30x60
R10
A
V3
R

60x9,5
R

30x60
V3
R





60x60
R9
V2
R

30x60
R9
V2
R

60x60
R10
B
V2
R

30x60
V2
R



DAK63660
PEI 5 \odot 82 / m²
mat | matt



DAKSE660
PEI 5 \odot 78 / m²
mat | matt

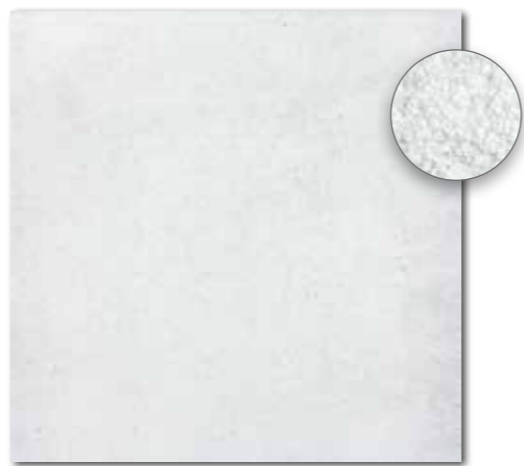

DAR63660
PEI 5 \odot 86 / m²
mat | matt



DARSE660
PEI 5 \odot 82 / m²
mat | matt | R10 | B

DAGSE660*
PEI 5 \odot 86 / m²
mat | matt | R11 | C

světle šedá / light grey / jasnoszara / светло-серый
világosszürke / gris claro

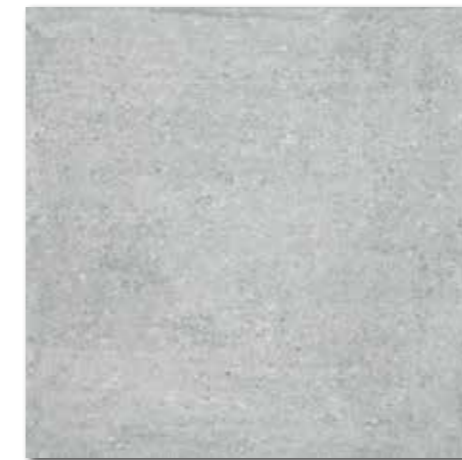

DAK63661
PEI 5 \odot 82 / m²
mat | matt



DAKSE661
PEI 5 \odot 78 / m²
mat | matt

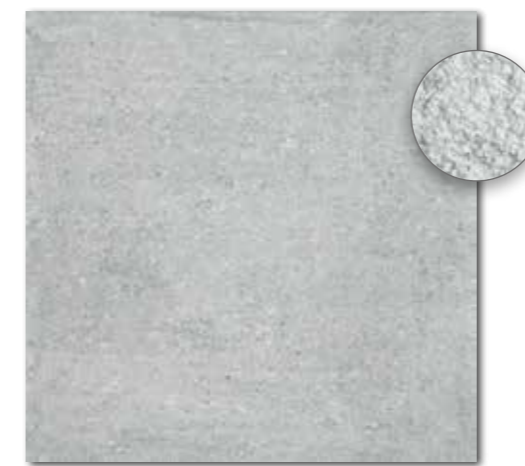

DAR63661
PEI 5 \odot 86 / m²
mat | matt



DARSE661
PEI 5 \odot 82 / m²
mat | matt | R10 | B

DAGSE661*
PEI 5 \odot 86 / m²
mat | matt | R11 | C

šedá / grey / szara / серый / szürke / gris



DAK63662
PEI 5 \odot 82 / m²
mat | matt



DAKSE662
PEI 5 \odot 78 / m²
mat | matt



DAR63662
PEI 5 \odot 86 / m²
mat | matt



DARSE662
PEI 5 \odot 82 / m²
mat | matt | R10 | B

DAGSE662*
PEI 5 \odot 86 / m²
mat | matt | R11 | C

šedo-běžová / grey-beige / szara-beżowa
серый-бежевый / szürke-bézs / beige-gris

výrobek / product



dlaždice / floor tile	60x60	598x598x10	EN 14411:2016, annex G B1a GL	3	2,8	1,08	32	34,56	24,9	23,0	820
dlaždice / floor tile	30x60	298x598x10	EN 14411:2016, annex G B1a GL	6	5,6	1,08	40	43,20	23,2	21,5	954

* Výroba na objednávku | Production by order | Produkcja na zamówienie | Производство под заказ | Gyártás rendelésre | Producción bajo demanda

Doporučené skladby formátů viz str. 325. | Recommended combinations of modular sizes see page 325. | Zalecane ułożenie modułowych formatów na stronie 325. | Рекомендуемый состав модульных форматов, см. стр. 325. | Composiciones de formatos recomendadas - vea la página n° 325.



DDPSE660
PEI 5 ○ 68 / ks
mat | matt



DDPSE661
PEI 5 ○ 68 / ks
mat | matt



DDPSE662
PEI 5 ○ 68 / ks
mat | matt



DDM06660 (SET)
PEI 5 ○ 72 / set
mat | matt



DDM06661 (SET)
PEI 5 ○ 72 / set
mat | matt



DDM06662 (SET)
PEI 5 ○ 72 / set
mat | matt



DCPSE660
PEI 5 ○ 72 / ks
mat | matt



DCPSE661
PEI 5 ○ 72 / ks
mat | matt



DCPSE662
PEI 5 ○ 72 / ks
mat | matt



DSAS4660
○ 58 / ks
mat | matt
světle šedá / light grey / jasnoszara / светло-серый
világosszürke / gris claro



DSAS4661
○ 58 / ks
mat | matt
šedá / grey / szara / серый / szürke / gris



DSAS4662
○ 58 / ks
mat | matt
šedo-běžová / grey-beige / szara-bežowa
серый-бежевый / szürke-bézs / beige-gris



30x60



R10



V2



R

30x30



R10



V2



R

30x60



R9



V2



R

60x9,5



výrobek / product	cm	mm	EN	ks/m ²	m ²	m ³	kg	kg/m ²	brutto kg
dekor / decor	30x60	298x598x10	EN 14411:2016, annex G B1a GL	4	5,6	0,72	-	15,5	21,5
mozaika set 30x30 cm / mosaic sheet 30x30 cm	5x5	48x48x10	STO č. 030 - 049913	3	11	0,27	-	5,8	21,5
schodovka / step tile	30x60	298x598x10	STO č. 030 - 049916	6	5,6	1,08	40	23,2	21,5
sokl / skirting plinth	60x9,5	598x95x10	STO č. 030 - 049916	13	17,5	0,74	-	15,9	21,5



DAK63659
PEI 4 ○ 78 / ks
mat | matt



DDPSU659
PEI 4 ○ 64 / ks
mat | matt



DAK44659
PEI 4 ○ 74 / ks
mat | matt



DDPD659
PEI 4 ○ 58 / ks
mat | matt
vícebarevná / multicoloured
kolorowa / многоцветный / többszínű / multicolor



60x60
R9
V4
R

15x60
R9
V4
R

45x45
R9
V4
R

15x45
R9
V4
R

výrobek / product



EN



ks/m²



kg/m²



brutto kg

výrobek / product	cm	mm	EN	mm	ks/m ²	m ²	kg	kg/m ²	brutto kg
dlaždice / floor tile	60x60	598x598x10	EN 14411:2016, annex G Bla GL	3	2,8	1,08	-	24,9	23,0
dlaždice / floor tile	15x60	148x598x10	EN 14411:2016, annex G Bla GL	10	11,1	0,90	-	19,4	21,5
dlaždice / floor tile	45x45	445x445x10	EN 14411:2016, annex G Bla GL	6	5	1,21	-	25,0	20,7
dlaždice / floor tile	15x45	147x445x10	EN 14411:2016, annex G Bla GL	15	15,1	0,99	-	20,5	20,7

Pro balení výrobků série Deco je typický nahodilý mix designů. DAK++659 zobrazené designy, DDP++659 až 24 možných designů. | The products of Deco serie are deliberately mixed in packing to include a random selection of designs. DAK++659 has 3 designs as shown, and DDP++659 has up to 24 possibilities.



DARSE687

PEI 4 78 / m²
mat | matt

světlo šedá / light grey / jasnoszara
светло-серый / világosszürke / gris claro

Doporučená spárovací hmota RAKO SYSTEM GF DRY 121 (manhattan)
Recommended grout RAKO SYSTEM GF DRY 121 (manhattan)



DARSE688

PEI 4 78 / m²
mat | matt

světlo béžová / light beige / jasnobežová
светло-бежевый / világosbézs / beige claro

Doporučená spárovací hmota RAKO SYSTEM GF DRY 121 (manhattan)
Recommended grout RAKO SYSTEM GF DRY 121 (manhattan)



DARSE689

PEI 4 78 / m²
mat | matt

červeno-hnědá / red-brown / czerwono-brązowy
красно-коричневый / vörösesbarna / de color marrón rojizo

Doporučená spárovací hmota RAKO SYSTEM GF DRY 134 (karamel)
Recommended grout RAKO SYSTEM GF DRY 134 (karamel)



DARSE690

PEI 4 78 / m²
mat | matt

šedohnědá / grey-brown / szarobrazowa
sero-korичневый / barna-szürke / gris-marrón

Doporučená spárovací hmota RAKO SYSTEM GF DRY 121 (manhattan)
Recommended grout RAKO SYSTEM GF DRY 121 (manhattan)



DARSE691

PEI 4 78 / m²
mat | matt

hnědá / brown / brązowa / коричневый / barna / marrón

Doporučená spárovací hmota RAKO SYSTEM GF DRY 121 (manhattan)
Recommended grout RAKO SYSTEM GF DRY 121 (manhattan)



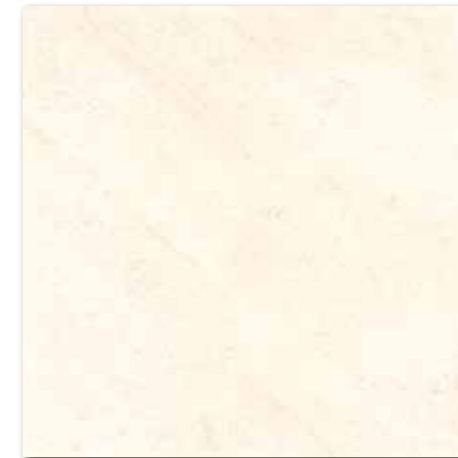

DAK63670
PEI 5 \odot 82 / m²
mat | matt



DAK63671
PEI 5 \odot 82 / m²
mat | matt

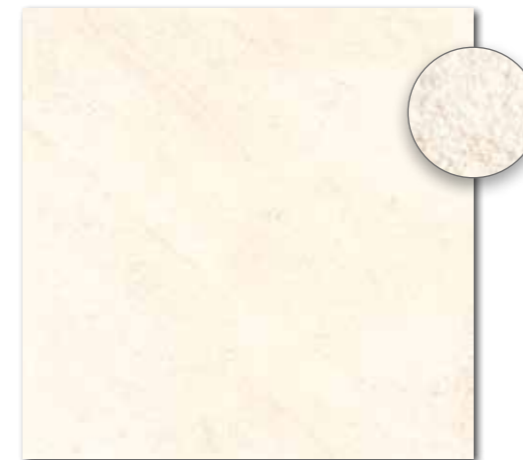

DAR63670
PEI 5 \odot 86 / m²
mat | matt



DAR63671
PEI 5 \odot 86 / m²
mat | matt



DDPSE670
PEI 5 \odot 78 / set
mat | matt

(SET)



DCPSE670
PEI 5 \odot 72 / ks
mat | matt



DCPSE671
PEI 5 \odot 72 / ks
mat | matt



DSAS4670
 \odot 58 / ks
mat | matt



DSAS4671
 \odot 58 / ks
mat | matt

světle béžová / light beige / jasnoběžová
светло-бежевый / világosbézs / beige claro

běžová / beige / bežowa / бежевый / bézs / beige

Všechny výrobky celé série vykazují velké odchylky odstínové difference V3. / All products of the entire batch show big deviations in shade difference V3. Wszystkie produkty w tej serii wykazują znaczne różnice odcieni V3. / Для всей плитки данной серии характерно значительное отличие оттенков V3. A termékszalát elemei jeletős színárnyalatobeli eltérést mutathatnak. / Todos los productos de la serie muestran grandes desviaciones en la diferencia de la tonalidad V3.

výrobek / product	cm	mm	EN	ks/m ²	m ²	m ²	kg	kg/m ²	brutto kg		
dlaždice / floor tile	60x60	598x598x10	EN 14411:2016, annex G Bla GL	3	2,8	1,08	32	34,56	24,9	23,0	820
dekor / decor	30x51	298x510x10	EN 14411:2016, annex G Bla GL	4	6,5	0,61	-	-	14,0	23,0	-
schodovka / step tile	30x60	298x598x10	STO č. 030 - 049916	6	5,6	1,08	40	-	23,2	21,5	-
sokl / skirting plinth	60x9,5	598x95x10	STO č. 030 - 049916	13	17,5	0,74	-	-	15,9	21,5	-







Všechny výrobky celé série vykazují velké odchylky odstínové difference V3. | All products of the entire batch show big deviations in shade difference V3. | Wszystkie produkty w tej serii wykazują znaczne różnice odcieni V3. | Для всей плитки данной серии характерно значительное отличие оттенков V3. | A termékeskálát elemei jeletős színárnyalatobeli eltérést mutathatnak. | Todos los productos de la serie muestran grandes desviaciones en la diferencia de la tonalidad V3.

Doporučené skladby formátů viz str. 325. | Recommended combinations of modular sizes see page 325. | Zalecane ułożenie modułowych formatów na stronie 325. | Рекомендуемый состав модульных форматов, см. стр. 325. | Composiciones de formatos recomendadas - vea la página n° 325.

Před pokládkou doporučujeme jednotlivé obkladové prvky vybírat z několika kartonů a výslednou plochu komponovat podle inspirativní fotodokumentace z katalogů RAKO případně z webových stránek www.rako.cz. | Žádoucí je kombinace všech jednotlivých designů obkladových prvků včetně jejich natáčení o 90° či 180°, aby se dosáhlo optimálního vyváženého vzhledu podlahy nebo stěny.

Before laying the tiles, we suggest you select from several cartons and arrange them as illustrated in the inspiration photo documentation in RAKO catalogues or website www.rako.eu, and mix the tiles to achieve the required result including turning them by 90° or 180°.

Przed wyklejeniem zaleca się wyciągnąć płytki z kilku kartonów i rozłożyć na jednej powierzchni. Przy układaniu można się inspirować zdjęciami w katalogu lub na stronach internetowych www.rako.eu. Wskazane jest przekładanie poszczególnych płytek, włącznie z ich obracaniem o 90° czy 180° aż do osiągnięcia optymalnego wyglądu ściany, czy podłogi.

A burkolólapok lerakása előtt javasoljuk, hogy több kartondobozból rakja ki a burkolólap elemeket és a végleges felületet a RAKO katalógusban található inspiratív fotódokumentáció vagy a www.rako.eu weblapon található képek alapján állítsa össze. Szükséges kombinálni az egyes burkolólap elemeket, illetve azokat 90° vagy 180°-kal is elforgatni az optimális és egyenletes padló- vagy falfelület kialakításához.

Перед укладкой рекомендуется вынуть отдельные элементы плитки из нескольких картонных коробок и составить желаемый рисунок, исходя из разных примеров, указанных на фото в каталогах RAKO или на сайте www.rako.eu. Для достижения оптимального гармоничного вида облицовки стен или плиточного покрытия пола желательно комбинировать отдельные элементы, поворачивая их на 90 - 180°.

Antes de la colocación siempre recomendamos desembalar varias cajas y probar a colocar el material en la composición elegida en los catálogos de RAKO en las páginas de internet web www.rako.eu. Se recomienda la colocación de todos los posibles elementos de la decoración incluso girar los individualmente entre sí 90° o 180°, para conseguir la composición deseada y equilibrada del pavimento o revestimiento.



DAR44663
PEI 5 ○ 78 / m²
mat | matt



DAR44664
PEI 4 ○ 78 / m²
mat | matt



DAR44665
PEI 4 ○ 78 / m²
mat | matt

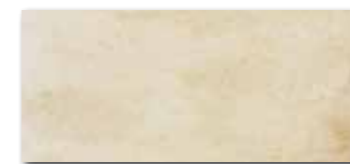

DARPP663
PEI 5 ○ 82 / m²
mat | matt



DARPP664
PEI 4 ○ 82 / m²
mat | matt



DARPP665
PEI 4 ○ 82 / m²
mat | matt



DAR2W663
PEI 5 ○ 82 / m²
mat | matt



DAR2W664
PEI 4 ○ 82 / m²
mat | matt



DAR2W665
PEI 4 ○ 82 / m²
mat | matt

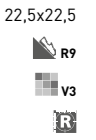

DDP44663 (SET)
PEI 5 ○ 72 / set
mat | matt



DDP44664 (SET)
PEI 4 ○ 72 / set
mat | matt



DDP44665 (SET)
PEI 4 ○ 72 / set
mat | matt



DSAPM663
○ 56 / ks
mat | matt

světle béžová / light beige / jasnobežowa
светло-бежевый / világosbézs / beige claro



DSAPM664
○ 56 / ks
mat | matt

hnědá / brown / brązowa
коричневый / barna / marrón



DSAPM665
○ 56 / ks
mat | matt

červeno-hnědá / red-brown / czerwono-brązowa
красно-коричневый / vörösesbarna
de color marrón rojizo



výrobek / product	cm	mm	EN	ks/m ²	m ²	m ²	kg	kg/m ²	brutto kg	
dlaždice / floor tile	45x45	445x445x10	EN 14411:2016, annex G B1a GL	6	5	1,21	26	31,46	25,0	677
dlaždice / floor tile	22,5x45	221x445x10	EN 14411:2016, annex G B1a GL	11	9,1	1,11	48	53,28	22,9	1 103
dlaždice / floor tile	22,5x22,5	221x221x10	EN 14411:2016, annex G B1a GL	24	19,8	1,22	45	54,90	25,2	658
dekor / decor	45x45	445x445x10	EN 14411:2016, annex G B1a GL	4	5	0,81	-	-	16,8	-
sokl / skirting plinth	45x8,5	445x85x10	STO č. 030 - 049916	20	26,1	0,77	-	-	15,9	-

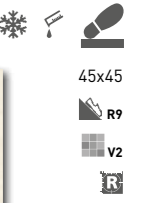

DAK44648
PEI 5 \odot 74 / m²
mat | matt



DAK44649
PEI 5 \odot 74 / m²
mat | matt



DAK44647
PEI 5 \odot 74 / m²
mat | matt



DAK44650
PEI 4 \odot 74 / m²
mat | matt



DAK44651
PEI 4 \odot 74 / m²
mat | matt



DDPPP648 (SET)
PEI 5 \odot 68 / set
mat | matt



DDPPP649 (SET)
PEI 5 \odot 68 / set
mat | matt



DDPPP647 (SET)
PEI 5 \odot 68 / set
mat | matt



DDPPP650 (SET)
PEI 4 \odot 68 / set
mat | matt



DDPPP651 (SET)
PEI 4 \odot 68 / set
mat | matt

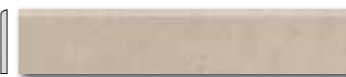

DSAPM648
 \odot 56 / ks
mat | matt
šedá / grey / szara / серый / szürke / gris

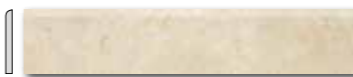

DSAPM649
 \odot 56 / ks
mat | matt
béžová / beige / bežowa / бежевый / bézs / beige

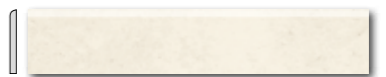

DSAPM647
 \odot 56 / ks
mat | matt
slonová kost / ivory / kość słoniowa / слоновья кость / elefántcsont / marfil



DSAPM650
 \odot 56 / ks
mat | matt
cihlová / brick / ceglata / кирпичный / téгла / ladrillo



DSAPM651
 \odot 56 / ks
mat | matt
hnědá / brown / brązowa / коричневый / barna / marrón



výrobek / product	mm	mm	EN	ks/m ²	m ²	kg	kg/m ²	brutto kg
dlaždice / floor tile	45x45	445x445x10	EN 14411:2016, annex G B1a GL	6	5	1,21	26	31,46
dekor 45x20 cm / decor 45x20 cm	7,5x5	72x48x10	STO č. 030 - 049913	6	11	0,55	-	11,5
sokl / skirting plinth	45x8,5	445x85x10	STO č. 030 - 049916	20	26,1	0,77	-	15,9

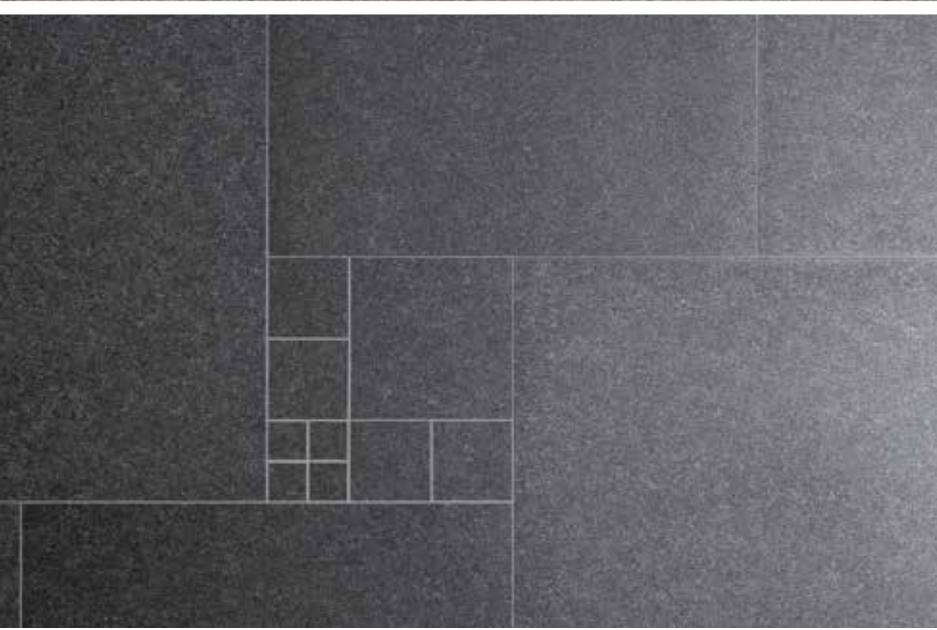



DAK63633
PEI 5 \odot 82 / m²
mat | matt | **R10** | **A**

DAP63633
PEI 5 \odot 88 / m²
lappato | lappato | **R9**



DAK63632
PEI 5 \odot 82 / m²
mat | matt | **R10** | **A**

DAP63632
PEI 5 \odot 88 / m²
lappato | lappato | **R9**



DAK63637
PEI 5 \odot 82 / m²
mat | matt | **R10** | **A**

DAP63637
PEI 5 \odot 88 / m²
lappato | lappato | **R9**



DAKSE633
PEI 5 \odot 78 / m²
mat | matt | **R10** | **A**

DAPSE633
PEI 5 \odot 82 / m²
lappato | lappato | **R9**

slonová kost / ivory / kość słoniowa / слоно́вая кость
elefántcsont / marfil



DAKSE632
PEI 5 \odot 78 / m²
mat | matt | **R10** | **A**

DAPSE632
PEI 5 \odot 82 / m²
lappato | lappato | **R9**

bílá / white / biata / белый / fehér / blanco

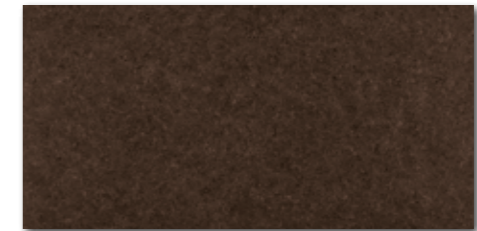

DAKSE637
PEI 5 \odot 78 / m²
mat | matt | **R10** | **A**

DAPSE637
PEI 5 \odot 82 / m²
lappato | lappato | **R9**

hnědá / brown / brązowa / коричневый / barna / marrón

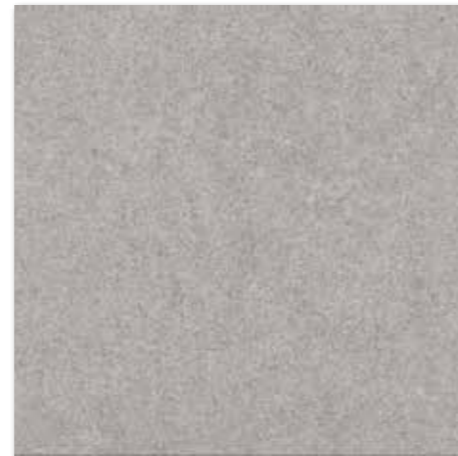

DAK63634
PEI 5 \odot 82 / m²
mat | matt | **R10** | **A**

DAP63634
PEI 5 \odot 88 / m²
lappato | lappato | **R9**



DAKSE634
PEI 5 \odot 78 / m²
mat | matt | **R10** | **A**

DAPSE634
PEI 5 \odot 82 / m²
lappato | lappato | **R9**

světle šedá / light grey / jasnoszara
светло-серый / világosszürke / gris claro

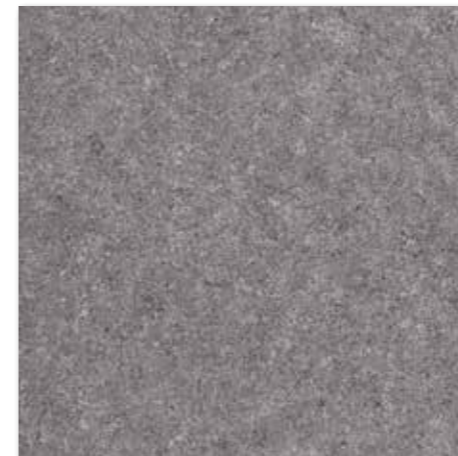

DAK63636
PEI 5 \odot 82 / m²
mat | matt | **R10** | **A**

DAP63636
PEI 5 \odot 88 / m²
lappato | lappato | **R9**

DAKSE636
PEI 5 \odot 78 / m²
mat | matt | **R10** | **A**

DAPSE636
PEI 5 \odot 82 / m²
lappato | lappato | **R9**

tmavě šedá / dark grey / ciemnoszara
темно-серый / sötétszürke / gris oscuro



DAK63635
PEI 5 \odot 82 / m²
mat | matt | **R10** | **A**

DAP63635
PEI 5 \odot 88 / m²
lappato | lappato | **R9**

DAKSE635
PEI 5 \odot 78 / m²
mat | matt | **R10** | **A**

DAPSE635
PEI 5 \odot 82 / m²
lappato | lappato | **R9**

černá / black / czarna / черный / fekete / negro

výrobek / product



dlaždice / floor tile	60x60	598x598x10	EN 14411:2016, annex G Bla GL	3	2,8	1,08	32	34,56	24,9	23,0	820
dlaždice / floor tile	30x60	298x598x10	EN 14411:2016, annex G Bla GL	6	5,6	1,08	40	43,20	23,2	21,5	954

Doporučené skladby formátů viz str. 325. | Recommended combinations of modular sizes see page 325. | Zalecane ułożenie modułowych formatów na stronie 325.
Рекомендуемый состав модульных форматов, см. стр. 325. | Composiciones de formatos recomendadas - vea la página n° 325.



60x60
R10
A
V2
R



DAK63644
PEI 5 ○ 88 / m²
mat | matt

30x60
R10
A
V2
R



DAKSE644
PEI 5 ○ 82 / m²
mat | matt
žltá / yellow / zółta / желтый / sárga / ámbar

60x60
R10
A
V2
R



DAK63646
PEI 5 ○ 88 / m²
mat | matt

30x60
R10
A
V2
R



DAKSE646
PEI 5 ○ 82 / m²
mat | matt
modrá / blue / niebieska / голубой / kék / azul

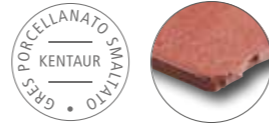

DAK63645
PEI 5 ○ 88 / m²
mat | matt



DAKSE645
PEI 5 ○ 82 / m²
mat | matt
červená / red / czerwony / красный / piros / gojo

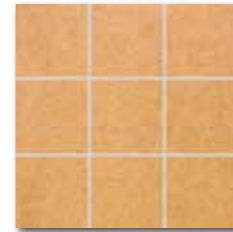

DAK12644
PEI 5 ○ 92 / m²
mat | matt | R10 | B | >6
žltá / yellow / zółta / желтый / sárga / ámbar

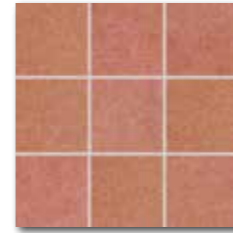

DAK12645
PEI 5 ○ 92 / m²
mat | matt | R10 | B | >6
červená / red / czerwony / красный / piros / gojo



DAK12646
PEI 5 ○ 92 / m²
mat | matt | R10 | B | >6
modrá / blue / niebieska / голубой / kék / azul



DAK1D644
PEI 5 ○ 88 / m²
mat | matt | R10 | B



DAK1D645
PEI 5 ○ 88 / m²
mat | matt | R10 | B



DAK1D646
PEI 5 ○ 88 / m²
mat | matt | R10 | B



DAK26644
PEI 5 ○ 88 / m²
mat | matt | R10 | A



DAK26645
PEI 5 ○ 88 / m²
mat | matt | R10 | A



DAK26646
PEI 5 ○ 88 / m²
mat | matt | R10 | A



10x10
15x15
20x20
V2
R

60x9,5
R



DSAS4644
○ 58 / ks
mat | matt
žltá / yellow / zółta / желтый / sárga / ámbar

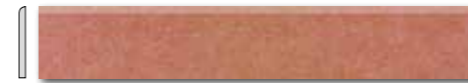

DSAS4645
○ 58 / ks
mat | matt
červená / red / czerwony / красный / piros / gojo



DSAS4646
○ 58 / ks
mat | matt
modrá / blue / niebieska / голубой / kék / azul

výrobek / product	cm	mm	EN	ks/m ²	m ²	m ³	kg	kg/m ²	brutto kg		
dlaždice / floor tile	60x60	598x598x10	EN 14411:2016, annex G Bla GL	3	2,8	1,08	32	34,56	24,9	23,0	820
dlaždice / floor tile	30x60	298x598x10	EN 14411:2016, annex G Bla GL	6	5,6	1,08	40	43,20	23,2	21,5	954

výrobek / product	cm	mm	EN	ks/m ²	m ²	m ³	kg	kg/m ²	brutto kg		
dlaždice / floor tile	10x10	98x98x10	EN 14411:2016, annex G Bla GL	10	11	0,91	56	50,96	19,6	21,5	1 121
dlaždice / floor tile	15x15	148x148x10	EN 14411:2016, annex G Bla GL	25	44	0,56	86	48,16	12,0	21,5	1 061
dlaždice / floor tile	20x20	198x198x10	EN 14411:2016, annex G Bla GL	23	25	0,92	57	52,44	21,2	23,0	1 232
sokl / skirting plinth	60x9,5	598x95x10	STO ě. 030 - 049916	13	17,5	0,74	-	-	15,9	21,5	-



10x10
15x15
20x20
30x30
v2



DAK12632
PEI 5 \circ 90 / m²
mat | matt | R10 | B | > |
biłá / white / biata / белый / fehér / blanco



DAK1D632
PEI 5 \circ 86 / m²
mat | matt | R10 | B |



DAK26632
PEI 5 \circ 86 / m²
mat | matt | R10 | A |



DAA34632
PEI 5 \circ 72 / m²
mat | matt | R10 | A |



DAK12634
PEI 5 \circ 90 / m²
mat | matt | R10 | B | > |
světle šedá / light grey / jasnoszara
светло-серый / világosszürke / gris claro



DAK1D634
PEI 5 \circ 86 / m²
mat | matt | R10 | B |



DAK26634
PEI 5 \circ 86 / m²
mat | matt | R10 | A |



DAA34634
PEI 5 \circ 72 / m²
mat | matt | R10 | A |



10x10
15x15
20x20
30x30
v2



DAK12633
PEI 5 \circ 90 / m²
mat | matt | R10 | B | > |
slonová kost / ivory / kość słoniowa
слоновая кость / elefántcsont / marfil



DAK1D633
PEI 5 \circ 86 / m²
mat | matt | R10 | B |



DAK26633
PEI 5 \circ 86 / m²
mat | matt | R10 | A |



DAA34633
PEI 5 \circ 72 / m²
mat | matt | R10 | A |

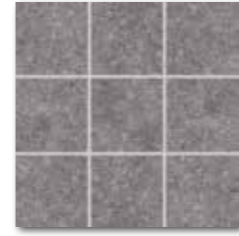

DAK12636
PEI 5 \circ 90 / m²
mat | matt | R10 | B | > |
tmavě šedá / dark grey / ciemnoszara
темно-серый / sötétszürke / gris oscuro



DAK1D636
PEI 5 \circ 86 / m²
mat | matt | R10 | B |



DAK26636
PEI 5 \circ 86 / m²
mat | matt | R10 | A |



DAA34636
PEI 5 \circ 72 / m²
mat | matt | R10 | A |



DAK12637
PEI 5 \circ 90 / m²
mat | matt | R10 | B | > |
hnědá / brown / brązowa
коричневый / barna / marrón



DAK1D637
PEI 5 \circ 86 / m²
mat | matt | R10 | B |



DAK26637
PEI 5 \circ 86 / m²
mat | matt | R10 | A |



DAA34637
PEI 5 \circ 72 / m²
mat | matt | R10 | A |

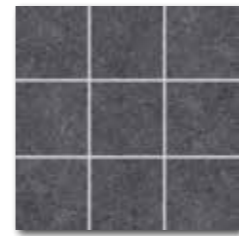

DAK12635
PEI 5 \circ 90 / m²
mat | matt | R10 | B | > |
černá / black / czarna / черный / fekete / negro



DAK1D635
PEI 5 \circ 86 / m²
mat | matt | R10 | B |



DAK26635
PEI 5 \circ 86 / m²
mat | matt | R10 | A |



DAA34635
PEI 5 \circ 72 / m²
mat | matt | R10 | A |





30x60
30x30
v2
R



DDVSE632
PEI 5 \odot 76 / ks
mat | matt | **R10** | **A**
bílá / white / biata / белый / fehér / blanco



DDM06632 (SET)
PEI 5 \odot 72 / set
mat | matt | **R10** | **B**



DDP34632 (SET)
PEI 5 \odot 72 / set
mat | matt | **R10** | **B**

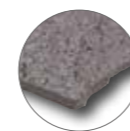

DDVSE634
PEI 5 \odot 76 / ks
mat | matt | **R10** | **A**
světle šedá / light grey / jasnoszara
светло-серый / világosszürke / gris claro

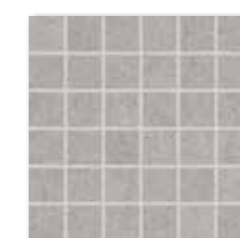

DDM06634 (SET)
PEI 5 \odot 72 / set
mat | matt | **R10** | **B**



DDP34634 (SET)
PEI 5 \odot 72 / set
mat | matt | **R10** | **B**



30x60
30x30
v2
R



DDVSE633
PEI 5 \odot 76 / ks
mat | matt | **R10** | **A**
slonová kost / ivory / kość stoniowa
слоновая кость / elefántcsont / marfil



DDM06633 (SET)
PEI 5 \odot 72 / set
mat | matt | **R10** | **B**

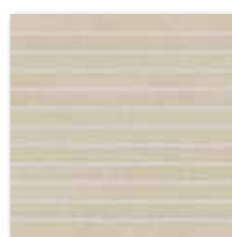

DDP34633 (SET)
PEI 5 \odot 72 / set
mat | matt | **R10** | **B**

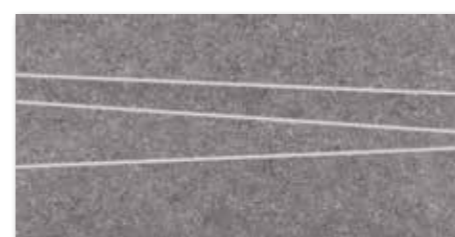

DDVSE636
PEI 5 \odot 76 / ks
mat | matt | **R10** | **A**
tmavě šedá / dark grey / ciemnoszara
темно-серый / sötétszürke / gris oscuro

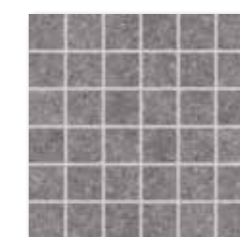

DDM06636 (SET)
PEI 5 \odot 72 / set
mat | matt | **R10** | **B**

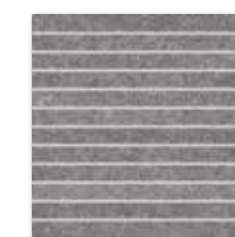

DDP34636 (SET)
PEI 5 \odot 72 / set
mat | matt | **R10** | **B**

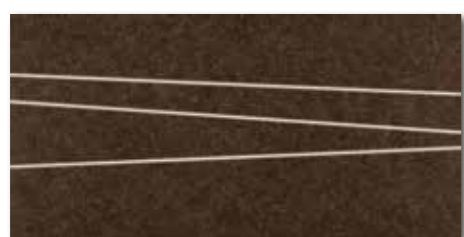

DDVSE637
PEI 5 \odot 76 / ks
mat | matt | **R10** | **A**
hnědá / brown / brązowa / коричневый / barna / marrón

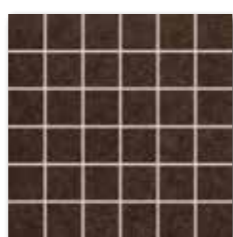

DDM06637 (SET)
PEI 5 \odot 72 / set
mat | matt | **R10** | **B**



DDP34637 (SET)
PEI 5 \odot 72 / set
mat | matt | **R10** | **B**

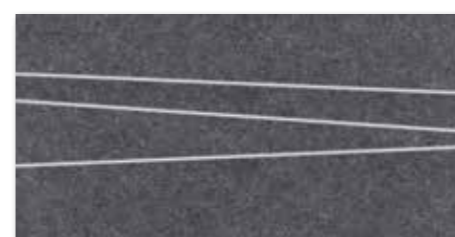

DDVSE635
PEI 5 \odot 76 / ks
mat | matt | **R10** | **A**
černá / black / czarna / черный / fekete / negro

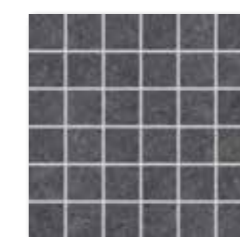

DDM06635 (SET)
PEI 5 \odot 72 / set
mat | matt | **R10** | **B**

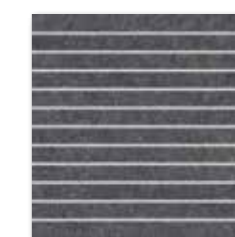

DDP34635 (SET)
PEI 5 \odot 72 / set
mat | matt | **R10** | **B**

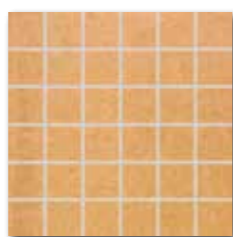

DDM06644 (SET)
PEI 5 \odot 72 / set
mat | matt | **R10** | **B**
žlutá / yellow / zółta / желтый / sárga / árbar



DDP34644 (SET)
PEI 5 \odot 72 / set
mat | matt | **R10** | **B**



DDM06645 (SET)
PEI 5 \odot 72 / set
mat | matt | **R10** | **B**
červená / red / czerwony / красный / piros / gojo

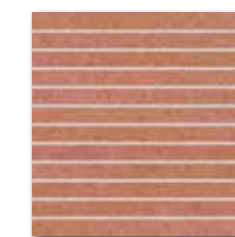

DDP34645 (SET)
PEI 5 \odot 72 / set
mat | matt | **R10** | **B**

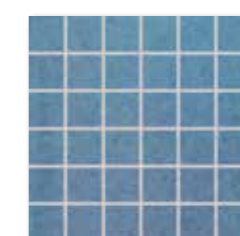

DDM06646 (SET)
PEI 5 \odot 72 / set
mat | matt | **R10** | **B**
modrá / blue / niebieska / голубой / kék / azul

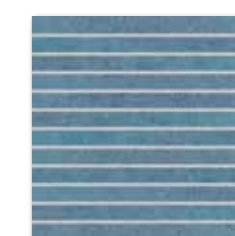

DDP34646 (SET)
PEI 5 \odot 72 / set
mat | matt | **R10** | **B**

výrobek / product	cm	mm	EN	ks/m ²	m ²	m ²	m ²	kg	kg/m ²	brutto kg	
dlaždice / floor tile	10x10	98x98x10	EN 14411:2016, annex G B1a GL	10	11	0,91	56	50,96	19,6	21,5	1 121
dlaždice / floor tile	15x15	148x148x10	EN 14411:2016, annex G B1a GL	25	44	0,56	86	48,16	12,0	21,5	1 061
dlaždice / floor tile	20x20	198x198x10	EN 14411:2016, annex G B1a GL	23	25	0,92	57	52,44	21,2	23,0	1 232
dlaždice / floor tile	30x30	298x298x8	EN 14411:2016, annex G B1a GL	13	11	1,18	48	56,64	21,0	17,8	1 034
dekor / decor	30x60	298x598x10	EN 14411:2016, annex G B1a GL	4	5,6	0,72	-	-	15,5	21,5	-
mozaika set 30x30 cm / mosaic sheet 30x30 cm	5x5	48x48x10	STO ě. 030 - 049913	3	11	0,27	-	-	5,8	21,5	-
dekor / decor	30x30	298x298x10	EN 14411:2016, annex G B1a GL	3	11	0,27	-	-	5,8	21,5	-



DCFSE632*
PEI 5 \odot 92 / ks
mat | matt | **R10** | **A**

bílá / white / biata / белый / fehér / blanco

DCGSE632*
PEI 5 \odot 96 / ks
lappato | lappato | **R9**



DCFSE634*
PEI 5 \odot 92 / ks
mat | matt | **R10** | **A**

světle šedá / light grey / jasnoszara / светло-серый / világosszürke / gris claro



DCPSE632
PEI 5 \odot 72 / ks
mat | matt

bílá / white / biata / белый / fehér / blanco



DCPSE634
PEI 5 \odot 72 / ks
mat | matt

světle šedá / light grey / jasnoszara / светло-серый / világosszürke / gris claro

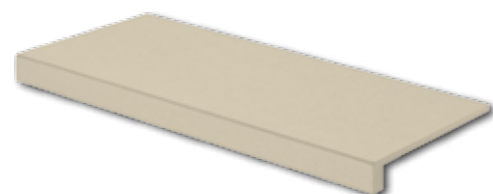

DCFSE633*
PEI 5 \odot 92 / ks
mat | matt | **R10** | **A**

slonová kost / ivory / kość stoniowa / слонобая кость / elefántcsont / marfil

DCGSE633*
PEI 5 \odot 96 / ks
lappato | lappato | **R9**



DCFSE636*
PEI 5 \odot 92 / ks
mat | matt | **R10** | **A**

tmavě šedá / dark grey / ciemnoszara / темно-серый / sötétszürke / gris oscuro

DCGSE636*
PEI 5 \odot 96 / ks
lappato | lappato | **R9**



DCPSE633
PEI 5 \odot 72 / ks
mat | matt

slonová kost / ivory / kość stoniowa / слонобая кость / elefántcsont / marfil



DCPSE636
PEI 5 \odot 72 / ks
mat | matt

tmavě šedá / dark grey / ciemnoszara / темно-серый / sötétszürke / gris oscuro



DCFSE637*
PEI 5 \odot 92 / ks
mat | matt | **R10** | **A**

hnědá / brown / brązowa / коричневый / barna / marrón

DCGSE637*
PEI 5 \odot 96 / ks
lappato | lappato | **R9**



DCFSE635*
PEI 5 \odot 92 / ks
mat | matt | **R10** | **A**

černá / black / czarna / черный / fekete / negro

DCGSE635*
PEI 5 \odot 96 / ks
lappato | lappato | **R9**

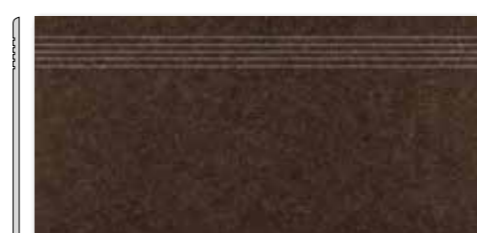

DCPSE637
PEI 5 \odot 72 / ks
mat | matt

hnědá / brown / brązowa / коричневый / barna / marrón



DCPSE635
PEI 5 \odot 72 / ks
mat | matt

černá / black / czarna / черный / fekete / negro

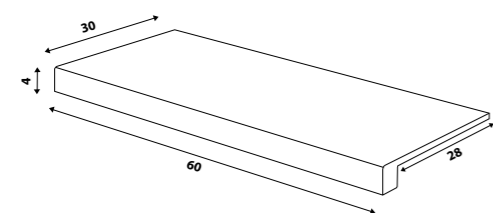

30x8,5
8,5x3



DSPJB632
DSPJB633
DSPJB634
DSPJB635
DSPJB636
DSPJB637
 \odot 56 / ks
mat | matt

DSIRB632
DSIRB633
DSIRB634
DSIRB635
DSIRB636
DSIRB637
 \odot 58 / ks
mat | matt

DSERB632
DSERB633
DSERB634
DSERB635
DSERB636
DSERB637
 \odot 58 / ks
mat | matt

bílá / white / biata / белый / fehér / blanco
slonová kost / ivory / kość stoniowa / слонобая кость / elefántcsont / marfil
světle šedá / light grey / jasnoszara / светло-серый / világosszürke / gris claro
černá / black / czarna / черный / fekete / negro
tmavě šedá / dark grey / ciemnoszara / темно-серый / sötétszürke / gris oscuro
hnědá / brown / brązowa / коричневый / barna / marrón



DSAS4632
 \odot 58 / ks
mat | matt

bílá / white / biata / белый / fehér / blanco

DSKS4632
 \odot 58 / ks
lappato | lappato



DSAS4634
 \odot 58 / ks
mat | matt

světle šedá / light grey / jasnoszara / светло-серый / világosszürke / gris claro

DSKS4634
 \odot 58 / ks
lappato | lappato



DSAS4633
 \odot 58 / ks
mat | matt

slonová kost / ivory / kość stoniowa / слонобая кость / elefántcsont / marfil

DSKS4633
 \odot 58 / ks
lappato | lappato



DSAS4636
 \odot 58 / ks
mat | matt

tmavě šedá / dark grey / ciemnoszara / темно-серый / sötétszürke / gris oscuro

DSKS4636
 \odot 58 / ks
lappato | lappato



DSAS4637
 \odot 58 / ks
mat | matt

hnědá / brown / brązowa / коричневый / barna / marrón

DSKS4637
 \odot 58 / ks
lappato | lappato



DSAS4635
 \odot 58 / ks
mat | matt

černá / black / czarna / черный / fekete / negro

DSKS4635
 \odot 58 / ks
lappato | lappato

výrobek / product	mm	mm	EN	ks/m ²	m ²	m ²	m ²	kg	kg/m ²	brutto kg
schodová tvarovka / special step tile	30x60	298x598x10	STO č. 030 - 049916	2	-	-	-	-	-	-
sokl s požábekem / cave skirting	30x8,5	298x85x8,5	STO č. 030 - 049916	40	-	-	-	-	-	-
sokl vnitřní roh / cave skirting inside corner	8,5x3	85x25	STO č. 030 - 049916	10	-	-	-	-	-	-
sokl vnější roh / cave skirting outside corner	8,5x3	85x27	STO č. 030 - 049916	10	-	-	-	-	-	-
schodovka / step tile	30x60	298x598x10	STO č. 030 - 049916	6	5,6	1,08	40	23,2	21,5	-
sokl / skirting plinth	60x9,5	598x95x10	STO č. 030 - 049916	13	17,5	0,74	-	15,9	21,5	-

* Výroba na objednávku | Production by order | Produkcja na zamówienie | Производство под заказ | Gyártás rendelésre | Producción bajo demanda

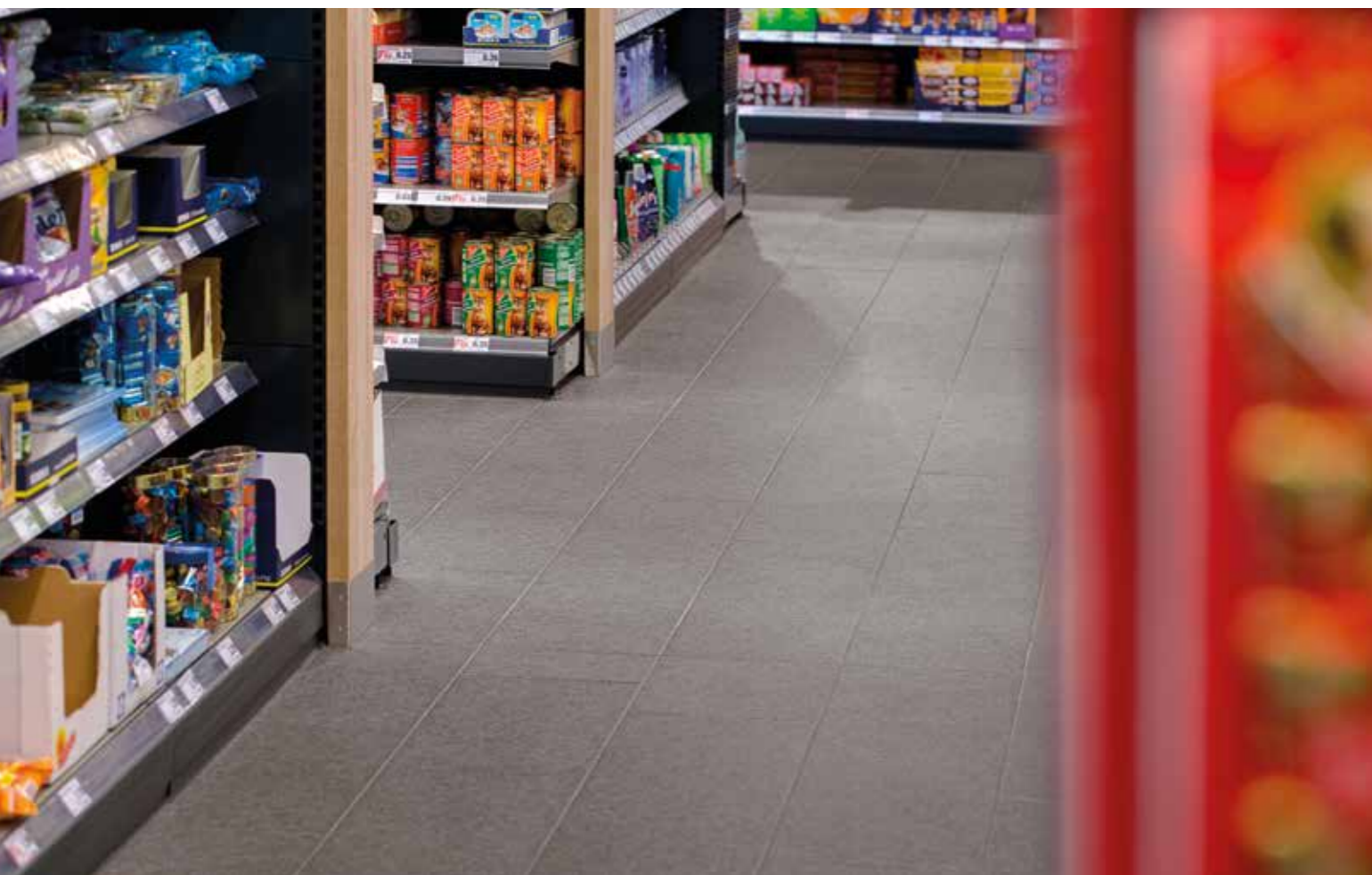

DAASG632
PEI 5 \bigcirc 90 / m²
mat | matt

bílá / white / biata / белый / fehér / blanco



DAASG634
PEI 5 \bigcirc 90 / m²
mat | matt

světle šedá / light grey / jasnoszara / светло-серый
világosszürke / gris claro



DAASG633
PEI 5 \bigcirc 90 / m²
mat | matt

stonová kost / ivory / kość stoniowa / слоновая кость
elefántcsont / marfil



DAASG636
PEI 5 \bigcirc 90 / m²
mat | matt

tmavě šedá / dark grey / ciemnoszara / темно-серый
sötétszürke / gris oscuro



DAASG637
PEI 5 \bigcirc 90 / m²
mat | matt

hnědá / brown / brązowa / коричневый / barna / marrón



DAASG635
PEI 5 \bigcirc 90 / m²
mat | matt

černá / black / czarna / черный / fekete / negro



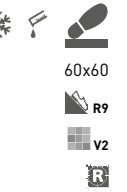
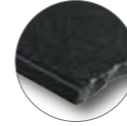
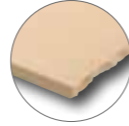

DAR63639
PEI 5 \odot 86 / m²
mat | matt



DARSE639
PEI 5 \odot 82 / m²
mat | matt

světle béžová / light beige / jasno-beżowa
светло-бежевый / világosbézs / beige claro

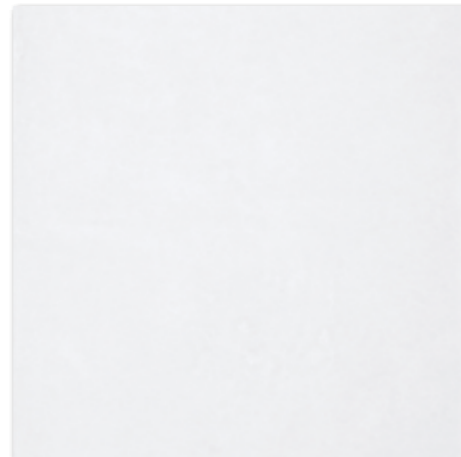

DAR63638
PEI 5 \odot 86 / m²
mat | matt

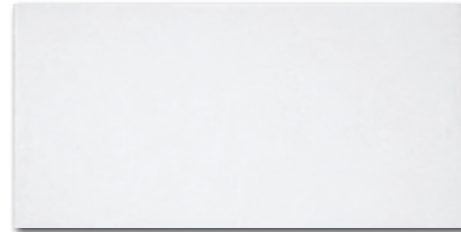

DARSE638
PEI 5 \odot 82 / m²
mat | matt

bílá / white / biata / белый / fehér / blanco



DAR63640
PEI 4 \odot 86 / m²
mat | matt



DARSE640
PEI 4 \odot 82 / m²
mat | matt

béžovo-šedá / beige-grey / beżowo-szary
бежевый-серый / bézs-szürke / beige-gris



DAR63642
PEI 4 \odot 86 / m²
mat | matt



DARSE642
PEI 4 \odot 82 / m²
mat | matt

tmavě šedá / dark grey / ciemnoszara
темно-серый / sötétszürke / gris oscuro



DAR63641
PEI 4 \odot 86 / m²
mat | matt



DARSE641
PEI 4 \odot 82 / m²
mat | matt

hnědá / brown / brązowa / коричневый / barna / marrón



DAR63643
PEI 4 \odot 86 / m²
mat | matt



DARSE643
PEI 4 \odot 82 / m²
mat | matt

černá / black / czarna / черный / fekete / negro



výrobek / product



EN



cm	mm	EN	ks/m ²	m ²	kg	kg/m ²	brutto kg			
60x60	598x598x10	EN 14411:2016, annex G B1a GL	3	2,8	1,08	32	34,56	24,9	23,0	820
30x60	298x598x10	EN 14411:2016, annex G B1a GL	6	5,6	1,08	40	43,20	23,2	21,5	954

Doporučené skladby formátů viz str. 325. | Recommended combinations of modular sizes see page 325. | Zalecane ułożenie modułowych formatów na stronie 325.
Рекомендуемый состав модульных форматов, см. стр. 325. | Composiciones de formatos recomendadas - vea la página n° 325.



30x60
R9
V2
R

30x30
R10
A
V2
R

30x60
R9
V2
R

60x9,5
R



DDVSE639
PEI 5 ○ 74 / ks
mat | matt

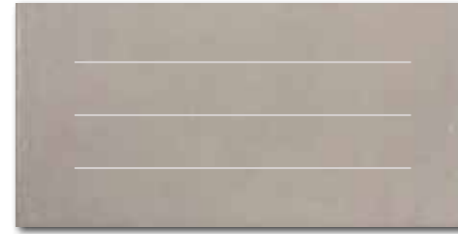

DDVSE640
PEI 4 ○ 74 / ks
mat | matt



DDVSE641
PEI 4 ○ 74 / ks
mat | matt

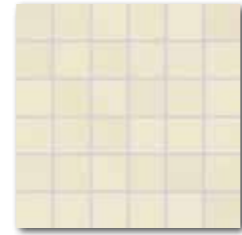

DDM06639 [SET]
PEI 5 ○ 72 / set
mat | matt

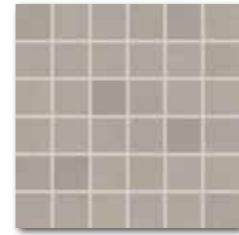

DDM06640 [SET]
PEI 4 ○ 72 / set
mat | matt

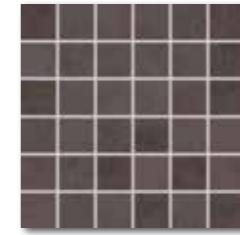

DDM06641 [SET]
PEI 4 ○ 72 / set
mat | matt



DCPSE639
PEI 5 ○ 72 / ks
mat | matt



DCPSE640
PEI 4 ○ 72 / ks
mat | matt



DCPSE641
PEI 4 ○ 72 / ks
mat | matt

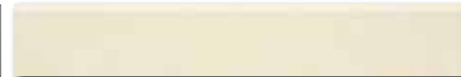

DSAS4639
○ 58 / ks
mat | matt

světle béžová / light beige / jasnobežowa
светло-бежевый / világosbézs / beige claro



DSAS4640
○ 58 / ks
mat | matt

běžovo-šedá / beige-grey / beżowo-szary
бежевый-серый / bézs-szürke / beige-gris



DSAS4641
○ 58 / ks
mat | matt

hnědá / brown / brązowa / коричневый / barna / marrón

výrobek / product



dekor / decor	30x60	298x598x10	EN 14411:2016, annex G B1a GL	4	5,6	0,72	-	-	15,5	21,5	-
mozaika set 30x30 cm / mosaic sheet 30x30 cm	5x5	48x48x10	STO č. 030 - 049913	3	11	0,27	-	-	5,8	21,5	-
schodovka / step tile	30x60	298x598x10	STO č. 030 - 049916	6	5,6	1,08	40	-	23,2	21,5	-
sokl / skirting plinth	60x9,5	598x95x10	STO č. 030 - 049916	13	17,5	0,74	-	-	15,9	21,5	-



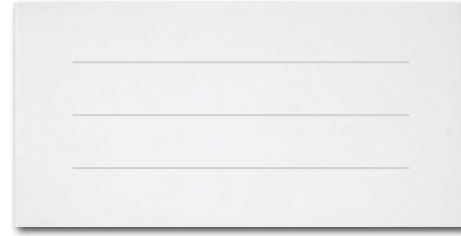

DDVSE638
PEI 5 \varnothing 74 / ks
mat | matt

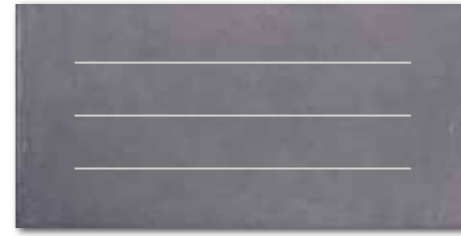

DDVSE642
PEI 4 \varnothing 74 / ks
mat | matt



DDVSE643
PEI 4 \varnothing 74 / ks
mat | matt



DDM06638 (SET)
PEI 5 \varnothing 72 / set
mat | matt

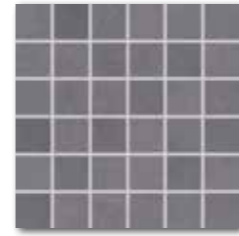

DDM06642 (SET)
PEI 4 \varnothing 72 / set
mat | matt

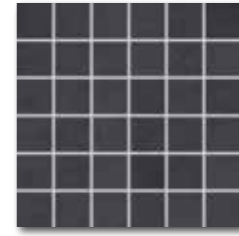

DDM06643 (SET)
PEI 4 \varnothing 72 / set
mat | matt



DCPSE638
PEI 5 \varnothing 72 / ks
mat | matt



DCPSE642
PEI 4 \varnothing 72 / ks
mat | matt



DCPSE643
PEI 4 \varnothing 72 / ks
mat | matt

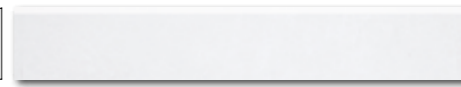

DSAS4638
 \varnothing 58 / ks
mat | matt
bilá / white / biata / белый / fehér / blanco



DSAS4642
 \varnothing 58 / ks
mat | matt
tmavě šedá / dark grey / ciemnoszara
темно-серый / sötétszürke / gris oscuro



DSAS4643
 \varnothing 58 / ks
mat | matt
černá / black / czarna / черный / fekete / negro



30x60
R9
V2
R



30x30
R10
A
V2
R



30x60
R9
V2
R



60x9,5
R

výrobek / product	cm	mm	EN	ks/m ²	kg/m ²	brutto kg
dekor / decor	30x60	298x598x10	EN 14411:2016, annex G B1a GL	4	5,6	0,72
mozaika set 30x30 cm / mosaic sheet 30x30 cm	5x5	48x48x10	STO č. 030 - 049913	3	11	0,27
schodovka / step tile	30x60	298x598x10	STO č. 030 - 049916	6	5,6	1,08
sokl. / skirting plinth	60x9,5	598x95x10	STO č. 030 - 049916	13	17,5	0,74

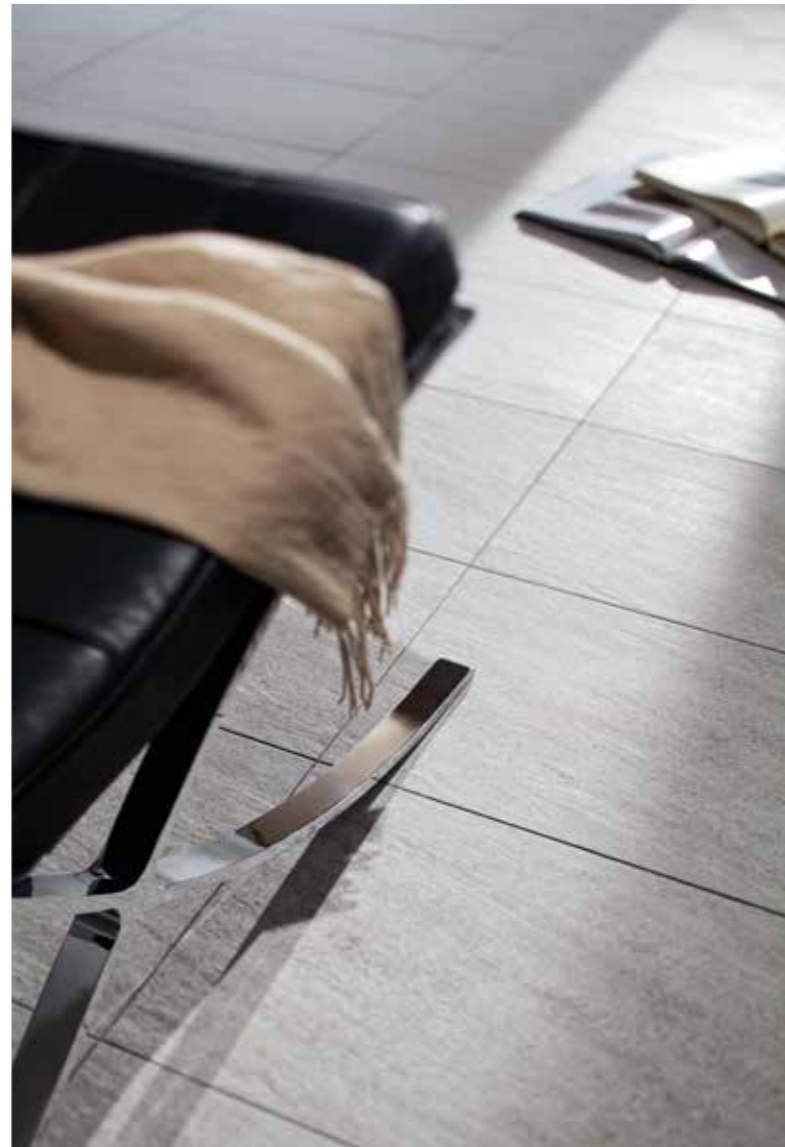



60x60
R10
A
V3
R



DAR63630
PEI 5 \odot 86 / m²
mat | matt



DAR63631
PEI 5 \odot 86 / m²
mat | matt



DAR63628
PEI 5 \odot 86 / m²
mat | matt



DAR63629
PEI 5 \odot 86 / m²
mat | matt

30x60
R10
A
V3
R



DARSE630
PEI 5 \odot 80 / m²
mat | matt



DARSE631
PEI 5 \odot 80 / m²
mat | matt



DARSE628
PEI 5 \odot 80 / m²
mat | matt



DARSE629
PEI 5 \odot 80 / m²
mat | matt

30x51
R10
B
V3
R



DDPSE630
PEI 5 \odot 78 / set
mat | matt



DDPSE631
PEI 5 \odot 78 / set
mat | matt



DDPSE628
PEI 5 \odot 78 / set
mat | matt



DDPSE629
PEI 5 \odot 78 / set
mat | matt

30x60
R10
A
V3
R



DCPSE630
PEI 5 \odot 72 / ks
mat | matt



DCPSE631
PEI 5 \odot 72 / ks
mat | matt



DCPSE628
PEI 5 \odot 72 / ks
mat | matt



DCPSE629
PEI 5 \odot 72 / ks
mat | matt

60x9,5
R



DSAS4630
 \odot 58 / ks
mat | matt

světle šedá / light grey / jasnoszara
светло-серый / világosszürke / gris claro



DSAS4631
 \odot 58 / ks
mat | matt

šedá / grey / szara / серый / szürke / gris



DSAS4628
 \odot 58 / ks
mat | matt

světle béžová / light beige / jasnobezowa
светло-бежевый / világosbézs / beige claro



DSAS4629
 \odot 58 / ks
mat | matt

béžová / beige / bežowa / бежевый / bézs / beige

výrobek / product

	cm	mm	EN		ks/m ²	m ²	m ²	kg	kg/m ²	brutto kg	
dlaždice / floor tile	60x60	598x598x10	EN 14411:2016, annex G B1a GL	3	2,8	1,08	32	34,56	24,9	23,0	820
dlaždice / floor tile	30x60	298x598x10	EN 14411:2016, annex G B1a GL	6	5,6	1,08	40	43,20	23,2	21,5	954
dekor / decor	30x51	298x510x10	EN 14411:2016, annex G B1a GL	4	6,5	0,61	-	-	13,1	21,5	-
schodovka / step tile	30x60	298x598x10	STO č. 030 - 049916	6	5,6	1,08	40	-	23,2	21,5	-
sokl / skirting plinth	60x9,5	598x95x10	STO č. 030 - 049916	13	17,5	0,74	-	-	15,9	21,5	-

Všetchny výrobky celé série vykazují velké odchylky odstínové diference V3. / All products of the entire batch show big deviations in shade difference V3.
Wszystkie produkty w tej serii wykazują znaczne różnice odcieni V3. / Для всей плитки данной серии характерно значительное отличие оттенков V3.
A termékszállát elemel jeletős színárnyalatobeli eltérést mutathatnak. / Todos los productos de la serie muestran grandes desviaciones en la diferencia de la tonalidad V3.

Doporučené skladyby formátů viz str. 325. | Recommended combinations of modular sizes see page 325. | Zalecane ułożenie modułowych formatów na stronie 325. | Рекомендуются состав модульных форматов, см. стр. 325. | Composiciones de formatos recomendadas - vea la página nº 325.



60x60
R10
A
V3
R

30x60
R10
A
V3
R

30x51
R10
B
V3
R

30x60
R10
A
V3
R

60x9,5
R





DAK63609
PEI 5 \odot 82 / m²
mat | matt | **R9**

DAR63609
PEI 5 \odot 86 / m²
mat | matt | **R10** | **A**



DAKSE609
PEI 5 \odot 76 / m²
mat | matt | **R9**

DARSE609
PEI 5 \odot 82 / m²
mat | matt | **R10** | **A**

bílá / white / biata / белый / fehér / blanco



DAK63610
PEI 5 \odot 82 / m²
mat | matt | **R9**

DAR63610
PEI 5 \odot 86 / m²
mat | matt | **R10** | **A**



DAKSE610
PEI 5 \odot 76 / m²
mat | matt | **R9**

DARSE610
PEI 5 \odot 82 / m²
mat | matt | **R10** | **A**

běžová / beige / beżowa / бежевый / bézs / beige



DAK63612
PEI 5 \odot 82 / m²
mat | matt | **R9**

DAR63612
PEI 5 \odot 86 / m²
mat | matt | **R10** | **A**



DAKSE612
PEI 5 \odot 76 / m²
mat | matt | **R9**

DARSE612
PEI 5 \odot 82 / m²
mat | matt | **R10** | **A**

šedohnědá / grey-brown / szarobrazowa
seryo-kopuqny / barna-szürke / gris-marrón



DAK63611
PEI 5 \odot 82 / m²
mat | matt | **R9**

DAR63611
PEI 5 \odot 86 / m²
mat | matt | **R10** | **A**



DAKSE611
PEI 5 \odot 76 / m²
mat | matt | **R9**

DARSE611
PEI 5 \odot 82 / m²
mat | matt | **R10** | **A**

šedá / grey / szara / серый / szürke / gris



DAK63613
PEI 5 \odot 82 / m²
mat | matt | **R9**

DAR63613
PEI 5 \odot 86 / m²
mat | matt | **R10** | **A**



DAKSE613
PEI 5 \odot 76 / m²
mat | matt | **R9**

DARSE613
PEI 5 \odot 82 / m²
mat | matt | **R10** | **A**

černá / black / czarna / черный / fekete / negro

výrobek / product



EN



brutto kg

dlaždice / floor tile	60x60	598x598x10	EN 14411:2016, annex G Bla GL	3	2,8	1,08	32	34,56	24,9	23,0	820
dlaždice / floor tile	30x60	298x598x10	EN 14411:2016, annex G Bla GL	6	5,6	1,08	40	43,20	23,2	21,5	954

Doporučené skladby formátů viz str. 325. | Recommended combinations of modular sizes see page 325. | Zalecane użożenie modułowych formatów na stronie 325. | Рекомендуемый состав модульных форматов, см. стр. 325. | Composiciones de formatos recomendadas - vea la página n° 325.



10x10
15x15
20x20
33x33
v2



30x30
30x60
v2
R



DAR12609
PEI 5 $\text{O } 90 / \text{m}^2$
mat | matt | R10 | B | A
biłá / white / biata / белый / fehér / blanco



DAR1D609
PEI 5 $\text{O } 86 / \text{m}^2$
mat | matt | R10 | B | A



DAR26609
PEI 5 $\text{O } 86 / \text{m}^2$
mat | matt | R10 | A | B



DAA3B609
PEI 5 $\text{O } 70 / \text{m}^2$
mat | matt | R9

DAR3B609
PEI 5 $\text{O } 78 / \text{m}^2$
mat | matt | R10 | A



DDM0U609 (SET)
PEI 5 $\text{O } 82 / \text{set}$
mat | matt | R10 | B
biłá / white / biata / белый / fehér / blanco



DDM06609 (SET)
PEI 5 $\text{O } 72 / \text{set}$
mat | matt | R10 | B



DDPSE609 (SET)
PEI 5 $\text{O } 68 / \text{set}$
mat | matt | R10 | A



DAR12610
PEI 5 $\text{O } 90 / \text{m}^2$
mat | matt | R10 | B | A
béžová / beige / bežowa / бежевый / bézs / beige



DAR1D610
PEI 5 $\text{O } 86 / \text{m}^2$
mat | matt | R10 | B | A



DAR26610
PEI 5 $\text{O } 86 / \text{m}^2$
mat | matt | R10 | A | B



DAA3B610
PEI 5 $\text{O } 70 / \text{m}^2$
mat | matt | R9

DAR3B610
PEI 5 $\text{O } 78 / \text{m}^2$
mat | matt | R10 | A



DDM0U610 (SET)
PEI 5 $\text{O } 82 / \text{set}$
mat | matt | R10 | B
béžová / beige / bežowa / бежевый / bézs / beige



DDM06610 (SET)
PEI 5 $\text{O } 72 / \text{set}$
mat | matt | R10 | B



DDPSE610 (SET)
PEI 5 $\text{O } 68 / \text{set}$
mat | matt | R10 | A



DAR12612
PEI 5 $\text{O } 90 / \text{m}^2$
mat | matt | R10 | B | A
šedohnědá / grey-brown / szarobrazowa / серо-коричневый / barna-szürke / gris-marrón



DAR1D612
PEI 5 $\text{O } 86 / \text{m}^2$
mat | matt | R10 | B | A



DAR26612
PEI 5 $\text{O } 86 / \text{m}^2$
mat | matt | R10 | A | B



DAA3B612
PEI 5 $\text{O } 70 / \text{m}^2$
mat | matt | R9

DAR3B612
PEI 5 $\text{O } 78 / \text{m}^2$
mat | matt | R10 | A

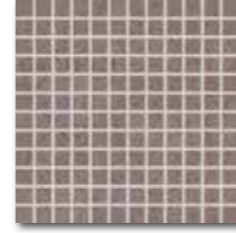
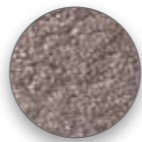

DDM0U612 (SET)
PEI 5 $\text{O } 82 / \text{set}$
mat | matt | R10 | B
šedohnědá / grey-brown / szarobrazowa / серо-коричневый / barna-szürke / gris-marrón

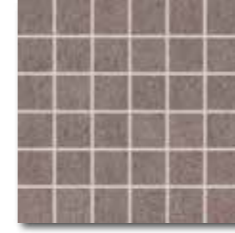

DDM06612 (SET)
PEI 5 $\text{O } 72 / \text{set}$
mat | matt | R10 | B



DDPSE612 (SET)
PEI 5 $\text{O } 68 / \text{set}$
mat | matt | R10 | A



DAR12611
PEI 5 $\text{O } 90 / \text{m}^2$
mat | matt | R10 | B | A
šedá / grey / szara / серый / szürke / gris



DAR1D611
PEI 5 $\text{O } 86 / \text{m}^2$
mat | matt | R10 | B | A



DAR26611
PEI 5 $\text{O } 86 / \text{m}^2$
mat | matt | R10 | A | B



DAA3B611
PEI 5 $\text{O } 70 / \text{m}^2$
mat | matt | R9

DAR3B611
PEI 5 $\text{O } 78 / \text{m}^2$
mat | matt | R10 | A

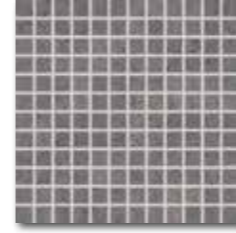
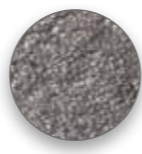

DDM0U611 (SET)
PEI 5 $\text{O } 82 / \text{set}$
mat | matt | R10 | B
šedá / grey / szara / серый / szürke / gris

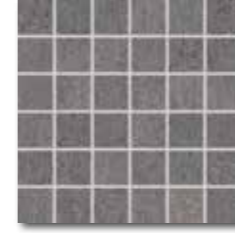

DDM06611 (SET)
PEI 5 $\text{O } 72 / \text{set}$
mat | matt | R10 | B



DDPSE611 (SET)
PEI 5 $\text{O } 68 / \text{set}$
mat | matt | R10 | A



DAR12613
PEI 5 $\text{O } 90 / \text{m}^2$
mat | matt | R10 | B | A
černá / black / czarna / черный / fekete / negro



DAR1D613
PEI 5 $\text{O } 86 / \text{m}^2$
mat | matt | R10 | B | A



DAR26613
PEI 5 $\text{O } 86 / \text{m}^2$
mat | matt | R10 | A | B



DAA3B613
PEI 5 $\text{O } 70 / \text{m}^2$
mat | matt | R9

DAR3B613
PEI 5 $\text{O } 78 / \text{m}^2$
mat | matt | R10 | A

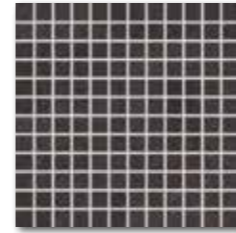

DDM0U613 (SET)
PEI 5 $\text{O } 82 / \text{set}$
mat | matt | R10 | B
černá / black / czarna / черный / fekete / negro

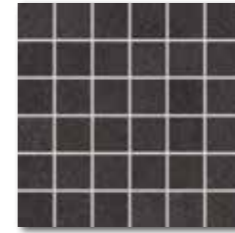

DDM06613 (SET)
PEI 5 $\text{O } 72 / \text{set}$
mat | matt | R10 | B



DDPSE613 (SET)
PEI 5 $\text{O } 68 / \text{set}$
mat | matt | R10 | A

výrobek / product	cm	mm	EN	mm	ks/m ²	m ²	kg	kg/m ²	brutto kg		
dlaždice / floor tile	10x10	98x98x10	EN 14411:2016, annex G Bla GL	10	11	0,91	56	50,96	19,6	21,5	1 121
dlaždice / floor tile	15x15	148x148x10	EN 14411:2016, annex G Bla GL	25	44	0,56	86	48,16	12,0	21,5	1 061
dlaždice / floor tile	20x20	198x198x10	EN 14411:2016, annex G Bla GL	23	25	0,92	57	52,44	21,2	23,0	1 232
dlaždice / floor tile	33x33	333x333x8	EN 14411:2016, annex G Bla GL	12	9	1,33	44	58,52	23,6	17,7	1 061

výrobek / product	cm	mm	EN	mm	ks/m ²	m ²	kg	kg/m ²	brutto kg		
mozaika set 30x30 cm / mosaic sheet 30x30 cm	2,5x2,5	23x23x10	STO E. 030 - 049913	3	11	0,27	-	-	5,8	21,5	-
mozaika set 30x30 cm / mosaic sheet 30x30 cm	5x5	48x48x10	STO E. 030 - 049913	3	11	0,27	-	-	5,8	21,5	-
dekor / decor	30x60	298x598x10	EN 14411:2016, annex G Bla GL	4	5,6	0,72	-	-	15,5	21,5	-



30x8,5
8,5x3

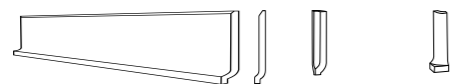

DSPJB609
DSPJB610
DSPJB611
DSPJB612
DSPJB613
○ 56 / ks
mat | matt

DSIRB609
DSIRB610
DSIRB611
DSIRB612
DSIRB613
○ 58 / ks
mat | matt

DSERB609
DSERB610
DSERB611
DSERB612
DSERB613
○ 58 / ks
mat | matt

bílá / white / biata / белый / fehér / blanco
béžová / beige / bežowa / бежевый / bézs / beige
šedá / grey / szara / серый / szürke / gris
šedohnědá / grey-brown / szarobrazowa / серо-коричневый / barna-szürke / gris-marrón
černá / black / czarna / черный / fekete / negro

výrobek / product



výrobek / product	cm	mm	EN	ks/m ²	m ²	m ³	kg	kg/m ²	brutto kg
sokl s pažábkem / cove skirting	30x8,5	298x85x8,5	STO č. 030 - 049916	40	-	-	-	-	-
sokl vnitřní roh / cove skirting inside corner	8,5x3	85x25	STO č. 030 - 049916	10	-	-	-	-	-
sokl vnější roh / cove skirting outside corner	8,5x3	85x27	STO č. 030 - 049916	10	-	-	-	-	-
schodovka / step tile	30x60	298x598x10	STO č. 030 - 049916	6	5,6	1,08	40	23,2	21,5
sokl / skirting plinth	60x9,5	598x95x10	STO č. 030 - 049916	13	17,5	0,74	-	15,9	21,5



DCPSE609
PEI 5 ○ 72 / ks
mat | matt
bílá / white / biata / белый / fehér / blanco



DCPSE610
PEI 5 ○ 72 / ks
mat | matt
béžová / beige / bežowa / бежевый / bézs / beige



DCPSE611
PEI 5 ○ 72 / ks
mat | matt
šedá / grey / szara / серый / szürke / gris



DCPSE612
PEI 5 ○ 72 / ks
mat | matt
šedohnědá / grey-brown / szarobrazowa / серо-коричневый / barna-szürke / gris-marrón



DCPSE613
PEI 5 ○ 72 / ks
mat | matt
černá / black / czarna / черный / fekete / negro

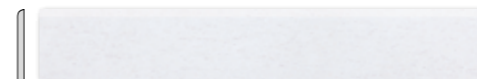

DSAS4609
○ 58 / ks
mat | matt
bílá / white / biata / белый / fehér / blanco



DSAS4610
○ 58 / ks
mat | matt
béžová / beige / bežowa / бежевый / bézs / beige



DSAS4611
○ 58 / ks
mat | matt
šedá / grey / szara / серый / szürke / gris



DSAS4612
○ 58 / ks
mat | matt
šedohnědá / grey-brown / szarobrazowa / серо-коричневый / barna-szürke / gris-marrón



DSAS4613
○ 58 / ks
mat | matt
černá / black / czarna / черный / fekete / negro

60x9,5
R



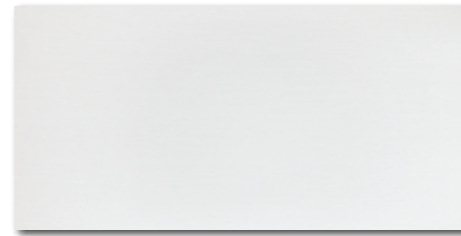

DAKSE622
PEI 5 ○ 82 / m²
mat | matt



DAKSE623
PEI 5 ○ 82 / m²
mat | matt



DAKSE624
PEI 4 ○ 82 / m²
mat | matt

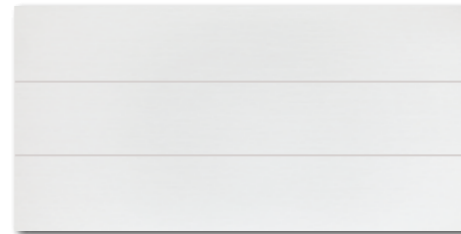

DDFSE622
PEI 5 ○ 58 / ks
mat | matt

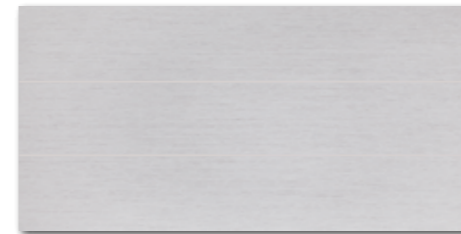

DDFSE623
PEI 5 ○ 58 / ks
mat | matt



DDFSE624
PEI 4 ○ 58 / ks
mat | matt

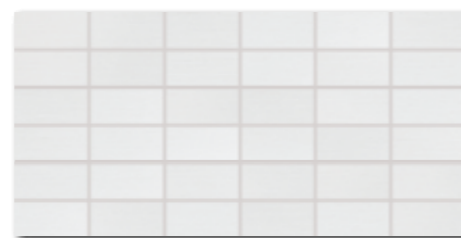

DDMBG622 (SET)
PEI 5 ○ 76 / set
mat | matt



DDMBG623 (SET)
PEI 5 ○ 76 / set
mat | matt



DDMBG624 (SET)
PEI 4 ○ 76 / set
mat | matt



DDRSN970
○ 78 / ks
lesk | glossy
oranžová / orange / pomarańczowa
оранжевый / narancs / naranja



DDRSN971
○ 78 / ks
lesk | glossy
červená / red / czerwona / красный / piros / rojo

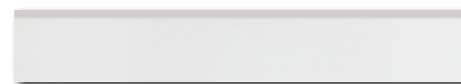

DSAS4622
○ 58 / ks
mat | matt
bílá / white / biata / белый / fehér / blanco

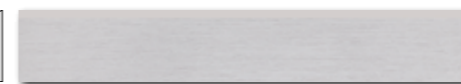

DSAS4623
○ 58 / ks
mat | matt
šedá / grey / szara / серый / szürke / gris



DSAS4624
○ 58 / ks
mat | matt
černá / black / czarna / черный / fekete / negro

výrobek / product	cm	mm	EN	ks/m ²	m ²	kg	kg/m ²	brutto kg			
dlaždice / floor tile	30x60	298x598x10	EN 14411:2016, annex G B1a GL	6	5,6	1,08	40	43,20	23,2	21,5	954
dekor / decor	30x60	298x598x10	EN 14411:2016, annex G B1a GL	4	5,6	0,72	-	-	15,5	21,5	-
mozaika set 30x60 cm / mosaic sheet 30x60 cm	5x10	48x98x10	STO č. 030 - 049913	4	5,6	0,72	-	-	15,5	21,5	-
listela / listel	60x2	598x20x10	EN 14411:2016, annex G B1a GL	6	83,3	0,07	-	-	1,6	22,7	-
sokl / skirting plinth	60x9,5	598x95x10	STO č. 030 - 049916	13	17,5	0,74	-	-	15,9	21,5	-

serie sandstone plus

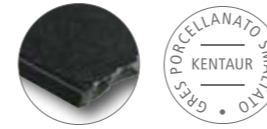

serie sandstone plus



DAK63272 PEI 5 \odot 86 / m² mat | matt | **R9** | **A**
 DAP63272 PEI 5 \odot 88 / m² lappato | lappato | **R9**

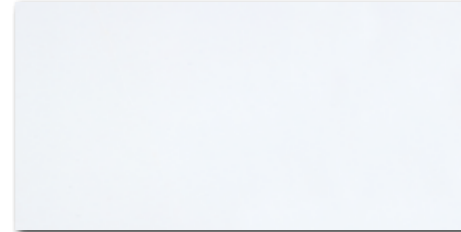

DAKSE272 PEI 5 \odot 78 / m² mat | matt | **R9** | **A**
 DAPSE272 PEI 5 \odot 82 / m² lappato | lappato | **R9**
 slonová kost / ivory / kość słoniowa / слоно́вая ко́сть / elefántcsont / marfil



DAK63271 PEI 5 \odot 86 / m² mat | matt | **R9** | **A**
 DAP63271 PEI 5 \odot 88 / m² lappato | lappato | **R9**

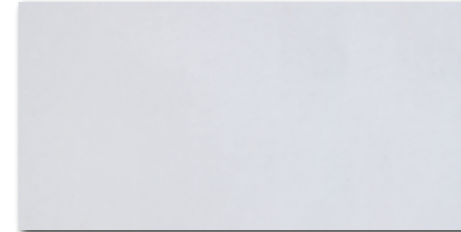

DAKSE271 PEI 5 \odot 78 / m² mat | matt | **R9** | **A**
 DAPSE271 PEI 5 \odot 82 / m² lappato | lappato | **R9**
 šedá / grey / szara / серый / szürke / gris



DAK63273 PEI 5 \odot 86 / m² mat | matt | **R9** | **A**
 DAP63273 PEI 5 \odot 88 / m² lappato | lappato | **R9**



DAKSE273 PEI 5 \odot 78 / m² mat | matt | **R9** | **A**
 DAPSE273 PEI 5 \odot 82 / m² lappato | lappato | **R9**
 černá / black / czarna / черный / fekete / negro



DAK63270 PEI 5 \odot 86 / m² mat | matt | **R9** | **A**
 DAP63270 PEI 5 \odot 88 / m² lappato | lappato | **R9**



DAKSE270 PEI 5 \odot 78 / m² mat | matt | **R9** | **A**
 DAPSE270 PEI 5 \odot 82 / m² lappato | lappato | **R9**
 okrová / ochre / ochrowa / oxpa / okker / ocre



DAK63274 PEI 5 \odot 86 / m² mat | matt | **R9** | **A**
 DAP63274 PEI 5 \odot 88 / m² lappato | lappato | **R9**



DAKSE274 PEI 5 \odot 78 / m² mat | matt | **R9** | **A**
 DAPSE274 PEI 5 \odot 82 / m² lappato | lappato | **R9**
 hnědá / brown / brązowa / коричневый / barna / marrón

výrobek / product



EN



ks/m²



m²



kg



brutto kg

dlaždice / floor tile	60x60	598x598x10	EN 14411:2016, annex G Bla GL	3	2,8	1,08	32	34,56	24,9	23,0	820
dlaždice / floor tile	30x60	298x598x10	EN 14411:2016, annex G Bla GL	6	5,6	1,08	40	43,20	23,2	21,5	954

Doporučené skladby formátů viz str. 325. | Recommended combinations of modular sizes see page 325. | Zalecane utożenie modułowych formatów na stronie 325. | Рекомендуемый состав модульных форматов, см. стр. 325. | Composiciones de formatos recomendadas - vea la página n° 325.

serie sandstone plus



serie sandstone plus



45x45
v3
R



DAK44272
PEI 5 \odot 78 / m²
mat | matt | R9 | A



DAP44271
PEI 5 \odot 78 / m²
mat | matt | R9 | A



DAK44273
PEI 5 \odot 78 / m²
mat | matt | R9 | A

DAP44273
PEI 5 \odot 82 / m²
lappato | lappato | R9



45x45
v3
R



DAK44270
PEI 5 \odot 78 / m²
mat | matt | R9 | A



DAP44274
PEI 5 \odot 82 / m²
lappato | lappato | R9

45x8,5
R

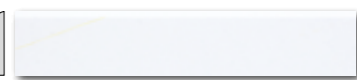

DSAPM272
 \odot 56 / ks
mat | matt



DSKPM272
 \odot 58 / ks
lappato | lappato



DSAPM273
 \odot 56 / ks
mat | matt

DSKPM273
 \odot 58 / ks
lappato | lappato

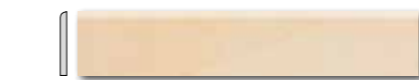

DSAPM270
 \odot 56 / ks
mat | matt



DSAPM274
 \odot 56 / ks
mat | matt

DSKPM274
 \odot 58 / ks
lappato | lappato

45x8,5
R

30x30
R10
B
v3
R

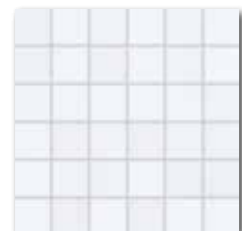

DDM06272 (SET)
PEI 5 \odot 72 / set
mat | matt
slonová kost / ivory / kość stoniowa
слоновая кость / elefántcsont / marfil

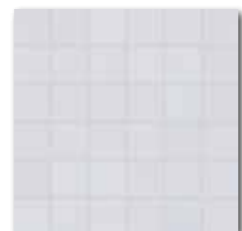

DDM06271 (SET)
PEI 5 \odot 72 / set
mat | matt
šedá / grey / szara
серый / szürke / gris



DDM06273 (SET)
PEI 5 \odot 72 / set
mat | matt
černá / black / czarna
черный / fekete / negro



DDM06270 (SET)
PEI 5 \odot 72 / set
mat | matt | v3
okrová / ochre / ochrowa
охра / okker / ocre

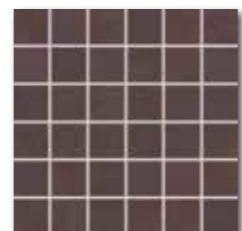

DDM06274 (SET)
PEI 5 \odot 72 / set
mat | matt | v3
hnědá / brown / brązowa
коричневый / barna / marrón



DDM06275 (SET)
PEI 5 \odot 72 / set
mat | matt | v4
vícebarevná / multicoloured / kolorowa
многоцветный / többszínű / multicolor

30x30
R10
B
R

30x30
>



VDM05032 (SET)
 \odot 74 / set
mat sklo | matt glass
bílá / white / biata
белый / fehér / blanco

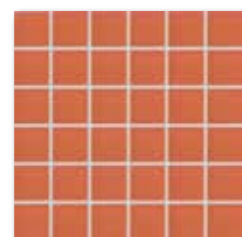

VDM05048 (SET)
 \odot 74 / set
mat sklo | matt glass
oranžová / orange / pomarańczowa
оранжевый / narancs / naranja

výrobek / product	cm	mm	EN	ks/m ²	m ²	kg	brutto kg
diaždice / floor tile	45x45	445x445x10	EN 14411:2016, annex G B1a GL	6	5	1,21	26
sokl / skirting plinth	45x8,5	445x85x10	STO č. 030 - 049916	20	26,1	0,77	-
mozaika set 30x30 cm / mosaic sheet 30x30 cm	5x5	48x48x10	STO č. 030 - 049913	3	11	0,27	-
mozaika set 30x30 cm sklo / sheet 30x30 cm glass	5x5	48x48x10	STO č. 030 - 049913	4	11	0,36	108
							46,20
							7,5
							20,9
							677
							-
							-
							991

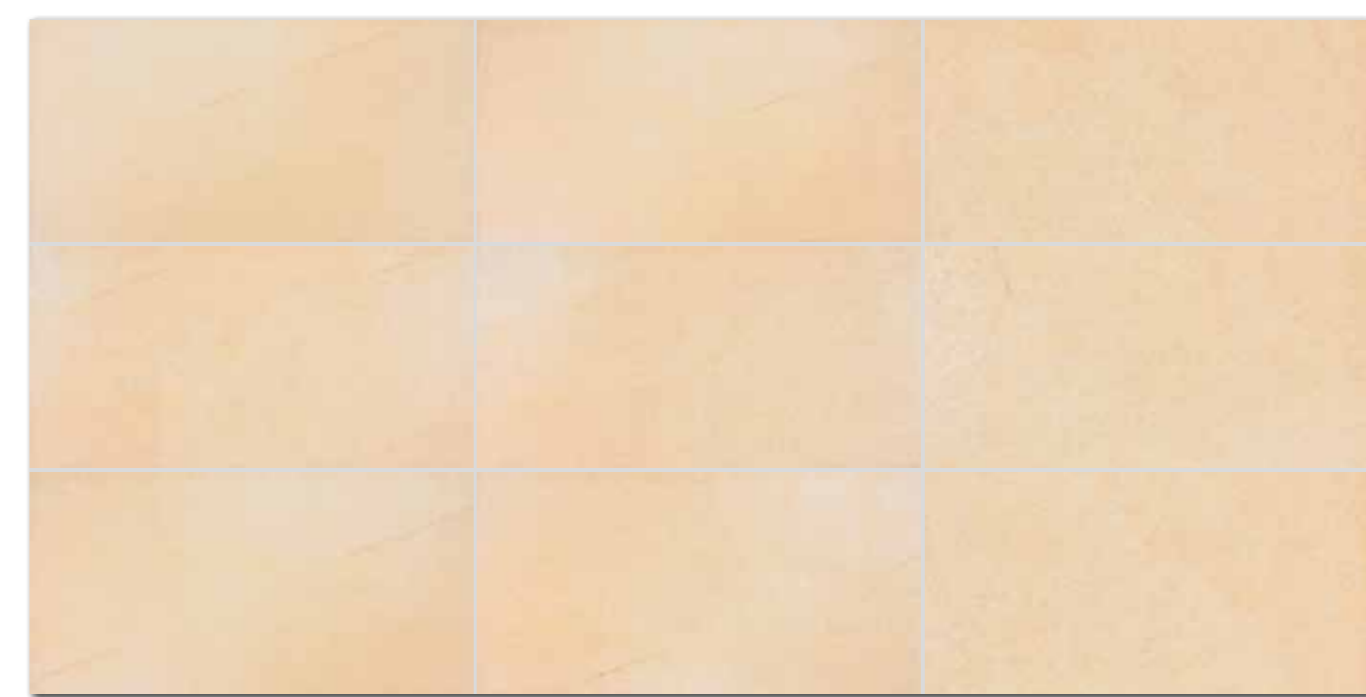

Všechny výrobky celé série vykazují velké odchylky odstínové diference V3. / All products of the entire batch show big deviations in shade difference V3. / Wszystkie produkty w tej serii wykazują znaczne różnice odcieni V3. / Для всей плитки данной серии характерно значительное отличие оттенков V3. / A termékszalát elemei jeletős színárnyalatobeli eltérést mutatnak. / Todos los productos de la serie muestran grandes desviaciones en la diferencia de la tonalidad V3.

serie sandstone plus



serie sandstone plus



DCPSE272
PEI 5 ○ 72 / ks
mat | matt
slonová kost / ivory / kość słoniowa / слоно́вая ко́сть / elefántcsont / marfil



DCPSE271
PEI 5 ○ 72 / ks
mat | matt
šedá / grey / szara / серый / szürke / gris



DCPSE270
PEI 5 ○ 72 / ks
mat | matt
okrová / ochre / ochrowa / oxpa / okker / ocre



DCPSE273
PEI 5 ○ 72 / ks
mat | matt
černá / black / czarna / черный / fekete / negro



DCPSE274
PEI 5 ○ 72 / ks
mat | matt
hnědá / brown / brązowa / коричневый / barna / marrón

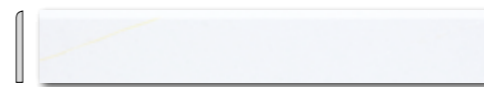

DSAS4272
○ 58 / ks
mat | matt
slonová kost / ivory / kość słoniowa / слоно́вая ко́сть / elefántcsont / marfil

DSKS4272
○ 58 / ks
lappato | lappato



DSAS4271
○ 58 / ks
mat | matt
šedá / grey / szara / серый / szürke / gris

DSKS4271
○ 58 / ks
lappato | lappato

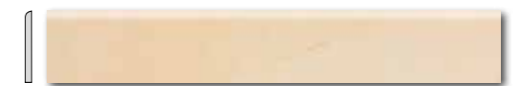

DSAS4270
○ 58 / ks
mat | matt
okrová / ochre / ochrowa / oxpa / okker / ocre

DSKS4270
○ 58 / ks
lappato | lappato



DSAS4273
○ 58 / ks
mat | matt
černá / black / czarna / черный / fekete / negro

DSKS4273
○ 58 / ks
lappato | lappato



DSAS4274
○ 58 / ks
mat | matt
hnědá / brown / brązowa / коричневый / barna / marrón

DSKS4274
○ 58 / ks
lappato | lappato

výrobek / product



EN



schodovka / step tile
sokl / skirting plinth

30x60
60x9,5

298x598x10
598x95x10

STO č. 030 - 049916
STO č. 030 - 049916

6
13

5,6
17,5

1,08
0,74

40
-

-
-

23,2
15,9

21,5
21,5

-
-



DAASE360
PEI 5 \odot 80 / m²
mat | matt



DAASE363
PEI 5 \odot 80 / m²
mat | matt



DAASE362
PEI 4 \odot 86 / m²
mat | matt



DAASE361
PEI 4 \odot 86 / m²
mat | matt



DDRSE360
PEI 4 \odot 82 / ks
mat | matt



DDRSE363
PEI 4 \odot 82 / ks
mat | matt



DDRSE362
PEI 4 \odot 82 / ks
mat | matt



DDRSE361
PEI 4 \odot 82 / ks
mat | matt



DDRST360
PEI 4 \odot 68 / ks
mat | matt
bílá / white / biata
белый / fehér / blanco



DDRST363
PEI 4 \odot 68 / ks
mat | matt
světle béžová / light beige
jasnobéžová / светло-бежевый
világosbézs / beige claro



DDRST362
PEI 4 \odot 68 / ks
mat | matt
béžová / beige / bežowa
бежевый / bézs / beige



DDRST361
PEI 4 \odot 68 / ks
mat | matt
hnědá / brown / brązowa
коричневый / barna / marrón



výrobek / product	mm	mm	EN	ks/m ²	m ²	m ²	kg	kg/m ²	brutto kg		
dlaždice / floor tile	30x60	298x598x10	EN 14411:2016, annex G Bla GL	6	5,6	1,08	40	43,20	23,2	21,5	954
rozeta / rosette	30x60	298x598x10	EN 14411:2016, annex G Bla GL	4	5,6	0,72	-	-	15,5	21,5	-
dlaždice bordura / floor tile listel	60x9,3	598x93x10	EN 14411:2016, annex G Bla GL	6	17,9	0,33	-	-	7,1	21,5	-



45x45



V2



DAA44362
PEI 4 ○ 86 / m²
mat | matt



DAA44361
PEI 4 ○ 86 / m²
mat | matt



DAA44360
PEI 5 ○ 80 / m²
mat | matt



DAA44363
PEI 5 ○ 80 / m²
mat | matt



45x45



V2



30x30



R10



V2



DDM06362 (SET)
PEI 4 ○ 72 / set
mat | matt

běžová / beige / bežowa
бежевый / bézs / beige

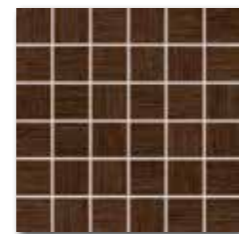

DDM06361 (SET)
PEI 4 ○ 72 / set
mat | matt

hnědá / brown / brązowa
коричневый / barna / marrón

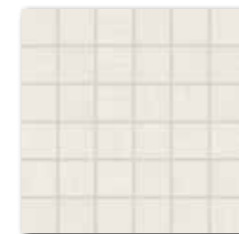

DDM06360 (SET)
PEI 5 ○ 72 / set
mat | matt



DDM06363 (SET)
PEI 5 ○ 72 / set
mat | matt

30x30



R10



V2



DSAPM360
○ 56 / ks
mat | matt

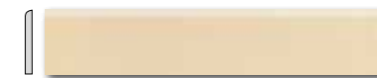

DSAPM363
○ 56 / ks
mat | matt

45x8,5



DCBPK360*
PEI 5 ○ 98 / ks
mat | matt
bílá / white / biata / белый
fehér / blanco

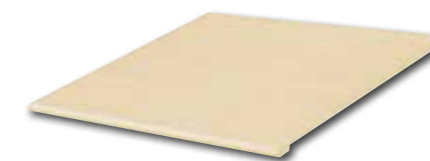

DCBPK363*
PEI 5 ○ 98 / ks
mat | matt
světle béžová / light beige / jasnobežowa
светло-бежевый / világosbézs / beige claro

45x42



V2

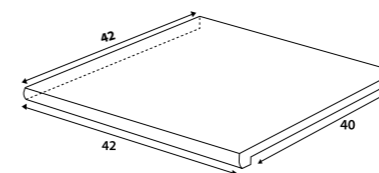

Florentinská schodovka roh levý*
Florentine step tile left corner*
DCC4J360 bílá / white
DCC4J363 světle béžová / light beige
PEI 5 ○ 100 / ks
mat | matt

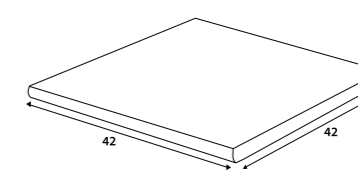

Florentinská schodovka roh pravý*
Florentine step tile right corner*
DCD4J360 bílá / white
DCD4J363 světle béžová / light beige
PEI 5 ○ 100 / ks
mat | matt

42x42



V2



výrobek / product	cm	mm	EN	ks/m ²	m ²	m ²	kg	kg/m ²	brutto kg	
dlaždice / floor tile	45x45	445x445x10	EN 14411:2016, annex G B1a GL	6	5	1,21	26	31,46	25,0	677
mozaika set 30x30 cm / mosaic sheet 30x30 cm	5x5	48x48x10	STO č. 030 - 049913	3	11	0,27	-	-	5,8	21,5
sokl / skirting plinth	45x8,5	445x85x10	STO č. 030 - 049916	20	26,1	0,77	-	-	15,9	20,7
florentinská schodovka* / florentine step tile*	45x42	445x420x10	STO č. 030 - 049916	4	5,3	0,75	-	-	16,8	21,6
florentinská schodovka roh* / florentine step tile corner*	42x42	420x420x10	STO č. 030 - 049916	4	5,7	0,71	-	-	16,8	21,6

* Výroba na objednávku | Production by order | Produkcja na zamówienie | Производство под заказ | Gyártás rendelésre | Producción bajo demanda

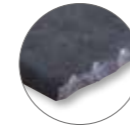

DAR44314
PEI 5 ○ 80 / m²
mat | matt



DDP44314 (SET)
PEI 5 ○ 72 / set
mat | matt | R10 | B | A

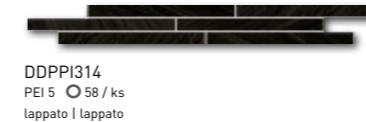

DDPPI314
PEI 5 ○ 58 / ks
lappato | lappato



DSAPM314
○ 56 / ks
mat | matt
černá / black / czarna / черный / fekete / negro

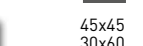

DARSE314
PEI 5 ○ 80 / m²
mat | matt

45x45
30x60

R10

A

V3

45x45
30x60

V3



DCPSE314
PEI 5 ○ 72 / ks
mat | matt | R10 | A

40x5

V3

V3

V3

45x8,5

výrobek / product	cm	mm	EN	ks/m ²	m ²	m ²	kg	kg/m ²	brutto kg		
dlaždice / floor tile	45x45	448x448x10	EN 14411:2016, annex G Bla GL	6	5	1,21	26	31,46	25,0	20,7	677
dlaždice / floor tile	30x60	303x602x10	EN 14411:2016, annex G Bla GL	6	5,6	1,08	40	43,20	24,0	22,2	985
dekor / decor	45x45	448x448x10	EN 14411:2016, annex G Bla GL	6	5	1,21	-	-	25,0	20,7	-
dlaždice bordura / floor tile listel	40x5	398x50x10	EN 14411:2016, annex G Bla GL	8	50	0,16	-	-	3,9	20,7	-
schodovka / step tile	30x60	303x602x10	STO č. 030 - 049916	6	5,6	1,08	40	-	24,0	22,2	-
sokl / skirting plinth	45x8,5	448x85x10	STO č. 030 - 049916	20	26,1	0,77	-	-	15,9	20,7	-

Všetchny výrobky celé série vykazují velké odchylky odstínové difference V3. / All products of the entire batch show big deviations in shade difference V3. / Wszystkie produkty w tej serii wykazują znaczne różnice odcieni V3. / Для всей плитки данной серии характерно значительное отличие оттенков V3. / A termékszcálát elemei jeletős színárnyalatobeli eltérést mutathatnak. / Todos los productos de la serie muestran grandes desviaciones en la diferencia de la tonalidad V3.

serie spirit



45x45
R9
V2
R



DAK44182
PEI 5 \odot 82 / m²
mat/lesk | matt/glossy



DAK44185
PEI 5 \odot 82 / m²
mat/lesk | matt/glossy



DAK44187
PEI 4 \odot 82 / m²
mat/lesk | matt/glossy



serie sidney



45x45
R9
V2

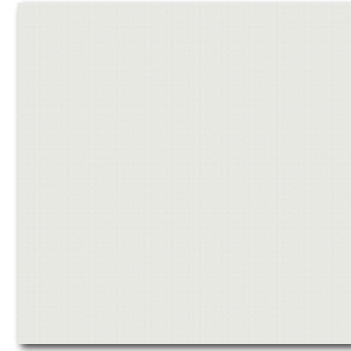

DAA44122
PEI 5 \odot 74 / m²
mat/lesk | matt/glossy

bilá / white / biata / белый / fehér / blanco

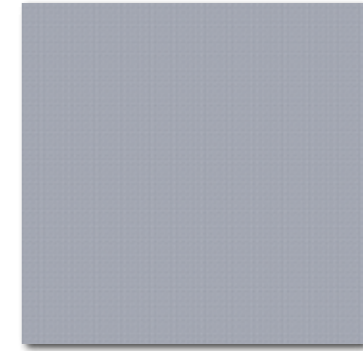

DAA44125
PEI 4 \odot 74 / m²
mat/lesk | matt/glossy

šedá / grey / szara / серый / szürke / gris

45x8,5
R

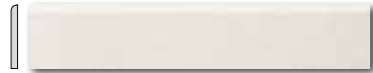

DSAPM182
 \odot 56 / ks
mat/lesk | matt/glossy

bilá / white / biata / белый / fehér / blanco



DSAPM185
 \odot 56 / ks
mat/lesk | matt/glossy

šedá / grey / szara / серый / szürke / gris



DSAPM187
 \odot 56 / ks
mat/lesk | matt/glossy

černá / black / czarna / черный / fekete / negro

45x45
R9
V2
R

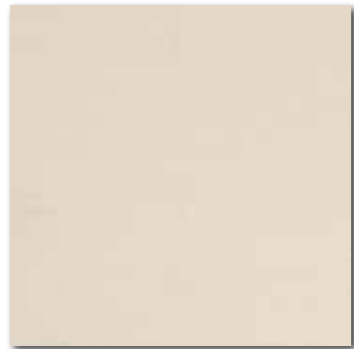

DAK44183
PEI 5 \odot 82 / m²
mat/lesk | matt/glossy

45x8,5
R



DSAPM183
 \odot 56 / ks
mat/lesk | matt/glossy

světle béžová / light beige / jasnobežowa
светло-бежевый / világosbézs / beige claro



výrobek / product	mm	mm	EN		ks/m ²	m ²	m ²	kg	kg/m ²	brutto kg	
dlaždice / floor tile	45x45	445x445x10	EN 14411:2016, annex G Bla GL	6	5	1,21	26	31,46	25,0	20,7	677
sokl / skirting plinth	45x8,5	445x85x10	STO č. 030 - 049916	20	26,1	0,77	-	-	15,9	20,7	-
dlaždice / floor tile	45x45	448x448x10	EN 14411:2016, annex G Bla GL	6	5	1,21	26	31,46	25,0	20,7	677





33x33

R9

A

V3



DAA3B695
PEI 5 ○ 68 / m²
mat | matt



DAA3B696
PEI 4 ○ 68 / m²
mat | matt



DAA3B697
PEI 4 ○ 68 / m²
mat | matt

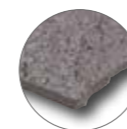

DDP3B695
PEI 5 ○ 78 / set
mat | matt



DDP3B696
PEI 4 ○ 78 / set
mat | matt



DDP3B697
PEI 4 ○ 78 / set
mat | matt



DDP3B698
PEI 4 ○ 78 / set
mat | matt

(SET)

světle šedá / light grey / jasnoszara / светло-серый / világosszürke / gris claro



DDP3B695
PEI 4 ○ 78 / set
mat | matt



DDP3B696
PEI 4 ○ 78 / set
mat | matt



DDP3B697
PEI 4 ○ 78 / set
mat | matt



DDP3B698
PEI 4 ○ 78 / set
mat | matt

(SET)

šedá / grey / szara / серый / szürke / gris



DDP3B697
PEI 4 ○ 78 / set
mat | matt



DDP3B698
PEI 4 ○ 78 / set
mat | matt



DDP3B699
PEI 4 ○ 78 / set
mat | matt



DDP3B700
PEI 4 ○ 78 / set
mat | matt

(SET)

tmavě šedá / dark grey / ciemnoszara / темно-серый / sötétszürke / gris oscuro

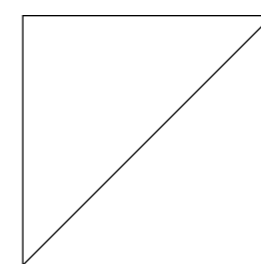

DDP3B697
PEI 4 ○ 78 / set
mat | matt

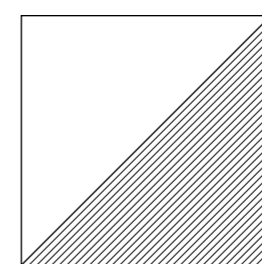

DDP3B698
PEI 4 ○ 78 / set
mat | matt

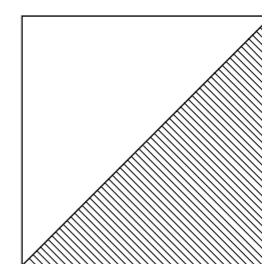

DDP3B699
PEI 4 ○ 78 / set
mat | matt

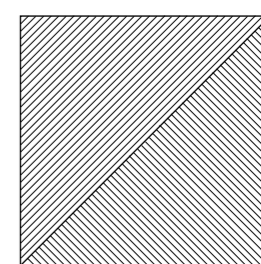

DDP3B700
PEI 4 ○ 78 / set
mat | matt

(SET)

30x30

R10

A

V3

R



DDM05695
PEI 5 ○ 72 / set
mat | matt

(SET)



DDM05696
PEI 4 ○ 72 / set
mat | matt

(SET)

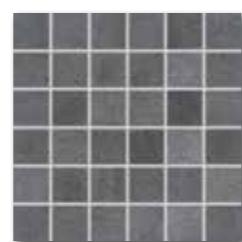

DDM05697
PEI 4 ○ 72 / set
mat | matt

(SET)



DDR05695
PEI 5 ○ 72 / set
mat | matt

(SET)



DDR05696
PEI 4 ○ 72 / set
mat | matt

(SET)



DDR05697
PEI 4 ○ 72 / set
mat | matt

(SET)

33x8

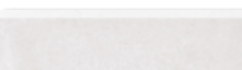

DSAL3695
○ 38 / ks
mat | matt
světle šedá / light grey / jasnoszara
светло-серый / világosszürke / gris claro



DSAL3696
○ 38 / ks
mat | matt
šedá / grey / szara / серый / szürke / gris



DSAL3697
○ 38 / ks
mat | matt
tmavě šedá / dark grey / ciemnoszara
темно-серый / sötétszürke / gris oscuro



33x33

R9

A

V3



DCP3B695
PEI 5 ○ 44 / ks
mat | matt

světle šedá / light grey / jasnoszara
светло-серый / világosszürke / gris claro



DCP3B696
PEI 4 ○ 44 / ks
mat | matt

šedá / grey / szara / серый / szürke / gris



DCP3B697
PEI 4 ○ 44 / ks
mat | matt

tmavě šedá / dark grey / ciemnoszara
темно-серый / sötétszürke / gris oscuro

33x33

R9

A

V3

výrobek / product



EN



výrobek / product	cm	mm	EN	ks/m ²	m ²	m ²	m ²	kg	kg/m ²	brutto kg	
dlaždice / floor tile	33x33	333x333x8	EN 14411-2016, annex G B1a GL	12	9	1,33	44	58,52	23,6	17,7	1 061
mozaika set 30x30 cm / mosaic sheet 30x30 cm	5x5	48x48x8	STO č. 030 - 049913	3	11	0,27	-	-	4,8	17,7	-
sokl / skirting plinth	33x8	333x80x8	STO č. 030 - 049916	30	37,5	0,80	-	-	14,2	17,7	-
dekor (set) / decor (set)	33x33	333x333x8	EN 14411-2016, annex G B1a GL	1	2,3	0,44	-	-	7,6	17,7	-
schodovka / step tile	33x33	333x333x8	STO č. 030 - 049916	12	9	1,33	44	-	23,6	17,7	-





DAR3B692
PEI 5 \odot 74 / m²
mat | matt



DAR3B693
PEI 5 \odot 74 / m²
mat | matt



DAR3B694
PEI 3 \odot 74 / m²
mat | matt



DDP3B692 (SET)
PEI 5 \odot 72 / set
mat | matt



DDP3B693 (SET)
PEI 5 \odot 72 / set
mat | matt



DDP3B694 (SET)
PEI 3 \odot 72 / set
mat | matt



DDM05692 (SET)
PEI 5 \odot 72 / set
mat | matt



DDM05693 (SET)
PEI 5 \odot 72 / set
mat | matt



DDM05694 (SET)
PEI 3 \odot 72 / set
mat | matt



DCP3B692
PEI 5 \odot 44 / ks
mat | matt



DCP3B693
PEI 5 \odot 44 / ks
mat | matt



DCP3B694
PEI 3 \odot 44 / ks
mat | matt



DSAL3692
 \odot 38 / ks
mat | matt
bílá / white / biata / белый / fehér / blanco



DSAL3693
 \odot 38 / ks
mat | matt
běžová / beige / bežowa
бежевый / bézs / beige



DSAL3694
 \odot 38 / ks
mat | matt
hnědočerná / brown-black / brązowa-czarna
коричневый-черный / barna-fekete / marrón-negro

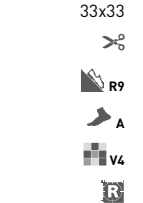
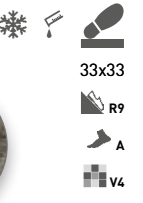

Všechny výrobky celé série vykazují velké odchylky odstínové difference V4. / All products of the entire batch show big deviations in shade difference V4.

Před pokládkou doporučujeme jednotlivé obkladové prvky vybrat z několika kartonů a výslednou plochu komponovat dle inspirativní fotodokumentace z katalogů RAKO případně z webových stránek www.rako.cz.
Žádoucí je kombinace všech jednotlivých designů obkladových prvků včetně jejich natočení o 90° či 180°, aby se dosáhlo optimálního vyváženého vzhledu podlahy nebo stěny.

Before laying the tiles, we suggest you select from several cartons and arrange them as illustrated in the inspiration photo documentation in RAKO catalogues or website www.rako.eu, and mix the tiles to achieve the required result including turning them by 90° or 180°.

Przed wyklejeniem zaleca się wyciągnąć płytki z kilku kartonów i rozłożyć na jednej powierzchni. Przy układaniu można się inspirować zdjęciami w katalogu lub na stronach internetowych www.rako.eu. Wskazane jest przekładanie poszczególnych płytek, włącznie z ich obracaniem o 90° czy 180° aż do osiągnięcia optymalnego wyglądu ściany, czy podłogi.

A burkolólapok lerakása előtt javasoljuk, hogy több kartondobozból rakja ki a burkolólap elemeket és a végleges felületet a RAKO katalógusban található inspiratív fotódokumentáció vagy a www.rako.eu weblapon található képek alapján állítsa össze. Szükséges kombinálni az egyes burkolólap elemeket, illetve azokat 90° vagy 180°-kal is elforgatni az optimális és egyenletes padló- vagy fal felület kialakításához.

Перед укладкой рекомендуется вынуть отдельные элементы плитки из нескольких картонных коробок и составить желаемый рисунок, исходя из разных примеров, указанных на фото в каталогах RAKO или на сайте www.rako.eu. Для достижения оптимального гармоничного вида облицовки стен или плиточного покрытия пола желательно комбинировать отдельные элементы, поворачивая их на 90 - 180°.

Antes de la colocación siempre recomendamos desembalar varias cajas y probar a colocar el material en la composición elegida en los catálogos de RAKO en las páginas de internet web www.rako.eu.

Se recomienda la colocación de todos los posibles elementos de la decoración incluso girar los individualmente entre sí 90° o 180°, para conseguir la composición deseada y equilibrada del pavimento o revestimiento.

výrobek / product	cm	mm	EN	ks/m ²	m ²	kg	kg/m ²	brutto kg
dlaždice / floor tile	33x33	333x333x8	EN 14411:2016, annex G Bla GL	12	9	1,33	44	58,52
dekor (set) / decor (set)	33x33	333x333x8	EN 14411:2016, annex G Bla GL	6	9	0,66	-	11,4
mozaika set 30x30 cm / mosaic sheet 30x30 cm	5x5	48x48x8	STO č. 030 - 049913	3	11	0,27	-	4,8
schodovka / step tile	33x33	333x333x8	STO č. 030 - 049916	12	9	1,33	44	23,6
sokl / skirting plinth	33x8	333x80x8	STO č. 030 - 049916	30	37,5	0,80	-	14,2





DAR3B706
PEI 5 \odot 72 / m²
mat | matt



DAR3B707
PEI 4 \odot 72 / m²
mat | matt



DAR3B708
PEI 4 \odot 72 / m²
mat | matt



DAR3B709
PEI 4 \odot 72 / m²
mat | matt



DDM05706 (SET)
PEI 5 \odot 72 / set
mat | matt
bílá / white / biata / белый
fehér / blanco



DDM05707 (SET)
PEI 4 \odot 72 / set
mat | matt
béžová / beige / beżowa
бежевый / bézs / beige



DDM05708 (SET)
PEI 4 \odot 72 / set
mat | matt
červeno-hnědá / red-brown
czegwono-brązowy
красно-коричневый
vörösésbarna
de color marrón rojizo



DDM05709 (SET)
PEI 4 \odot 72 / set
mat | matt
hnědá / brown / brązowa
коричневый / barna / marrón

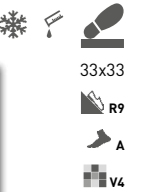

Všechny výrobky celé série vykazují velké odchylky odstínové difference V4. / All products of the entire batch show big deviations in shade difference V4.

Před pokládkou doporučujeme jednotlivé obkladové prvky vybírat z několika kartonů a výslednou plochu komponovat podle inspirativní fotodokumentace z katalogů RAKO případně z webových stránek www.rako.cz
Pro dosažení optimálního efektu doporučujeme pokládku jednotlivých dlaždic jedním směrem.

Before laying the tiles, we suggest you select from several cartons and arrange them as illustrated in the inspiration photo documentation in RAKO catalogues or website www.rako.eu
For optimal effect, the laying of individual tiles in one direction is recommended.

Przed wyklejeniem zaleca się wyciągnąć płytki z kilku kartonów i rozłożyć na jednej powierzchni. Przy układaniu można się inspirować zdjęciami w katalogu lub na stronach internetowych www.rako.eu. W celu uzyskania optymalnego efektu, zalecamy układanie płytek w jednym kierunku.

A burkolólapok lerakása előtt javasoljuk, hogy több kartondobozból rakja ki a burkolólap elemeket és a végleges felületet a RAKO katalógusban található inspiratív fotódokumentáció vagy a www.rako.eu weblapon található képek alapján állítsa össze.
Az optimális hatás érdekében az egyes lapok burkolását egy irányban javasoljuk.

Перед укладкой рекомендуется вынуть отдельные элементы плитки из нескольких картонных коробок и составить желаемый рисунок, исходя из разных примеров, указанных на фото в каталогах RAKO или на сайте www.rako.eu
Для достижения оптимального эффекта рекомендуем укладку каждой отдельной плитки в одном направлении.

Antes de la colocación siempre recomendamos desembalar varias cajas y probar a colocar el material en la composición elegida en los catálogos de RAKO en las páginas de internet web www.rako.eu
Para conseguir el mejor efecto, recomendamos colocar todas las baldosas en una dirección.

výrobek / product



výrobek / product	33x33	333x333x8	EN	12	9	1,33	44	58,52	23,6	17,7	1 061
dlaždice / floor tile	33x33	333x333x8	EN 14411:2016, annex G Bla GL	12	9	1,33	44	58,52	23,6	17,7	1 061
mozaika set 30x30 cm / mosaic sheet 30x30 cm	5x5	48x48x8	STO č. 030 - 049913	3	11	0,27	-	-	4,8	17,7	-





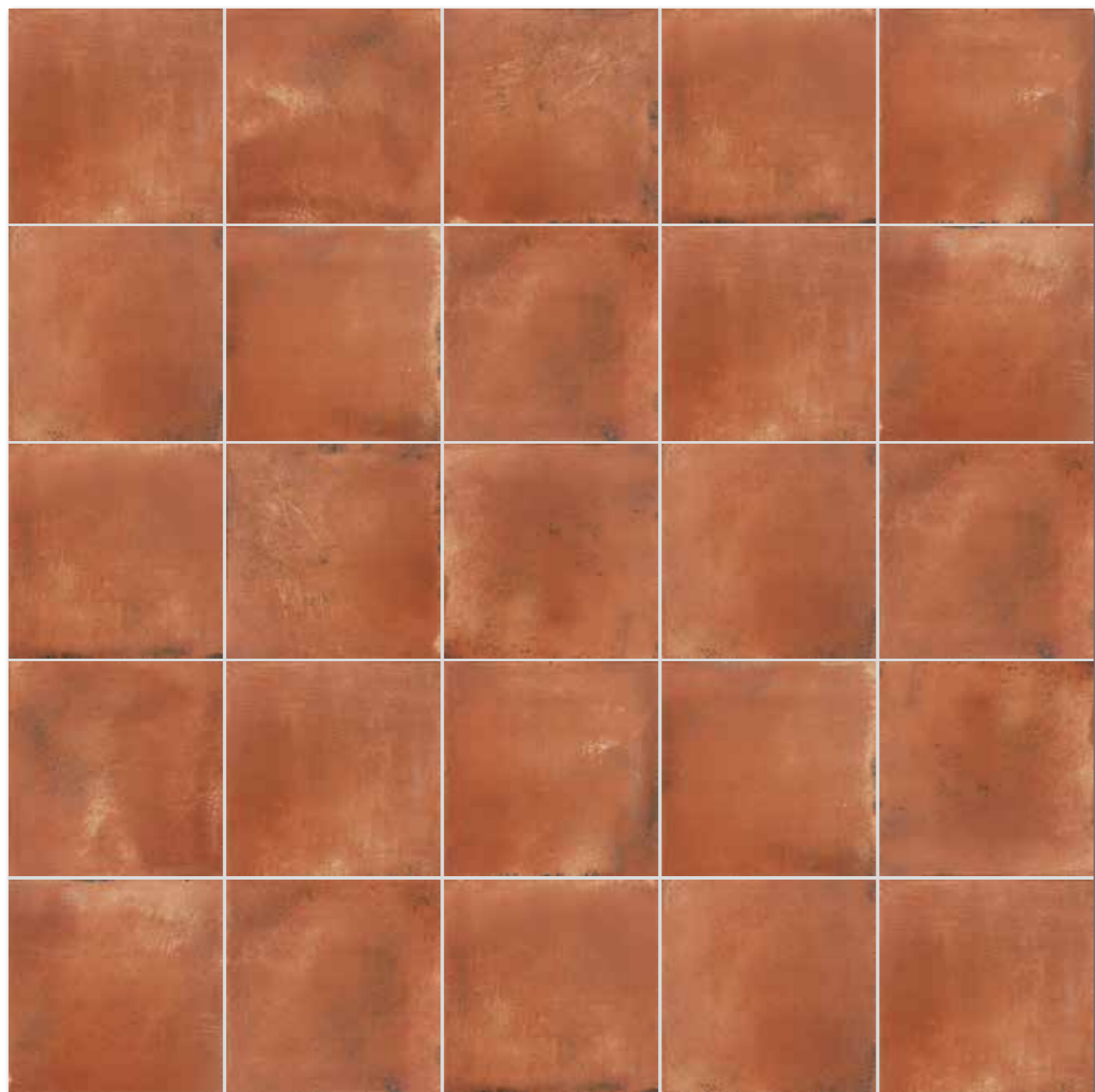

Všechny výrobky celé série vykazují velké odchylky odstínové difference V4. / All products of the entire batch show big deviations in shade difference V4.

Před pokládkou doporučujeme jednotlivé obkladové prvky vybírat z několika kartonů a výslednou plochu komponovat podle inspirativní fotodokumentace z katalogů RAKO případně z webových stránek www.rako.eu.

Žádoucí je kombinace všech jednotlivých designů obkladových prvků včetně jejich natáčení o 90° či 180°, aby se dosáhlo optimálního vyváženého vzhledu podlahy nebo stěny.

Before laying the tiles, we suggest you select from several cartons and arrange them as illustrated in the inspiration photo documentation in RAKO catalogues or website www.rako.eu, and mix the tiles to achieve the required result including turning them by 90° or 180°.

Przed wyklejeniem zaleca się wyciągnąć płytki z kilku kartonów i rozłożyć na jednej powierzchni. Przy układaniu można się inspirować zdjęciami w katalogu lub na stronach internetowych www.rako.eu. Wskazane jest przekładanie poszczególnych płytek, włącznie z ich obracaniem o 90° czy 180° aż do osiągnięcia optymalnego wyglądu ściany, czy podłogi.

A burkolólapok lerakása előtt javasoljuk, hogy több kartondobozból rakja ki a burkolólap elemeket és a végleges felületet a RAKO katalógusban található inspiratív fotódokumentáció vagy a www.rako.eu weblapon található képek alapján állítsa össze. Szükséges kombinálni az egyes burkolólap elemeket, illetve azokat 90° vagy 180°-kal is elforgatni az optimális és egyenletes padló- vagy falfelület kialakításához.

Перед укладкой рекомендуется вынуть отдельные элементы плитки из нескольких картонных коробок и составить желаемый рисунок, исходя из разных примеров, указанных на фото в каталогах RAKO или на сайте www.rako.eu. Для достижения оптимального гармоничного вида облицовки стен или плиточного покрытия пола желательно комбинировать отдельные элементы, поворачивая их на 90° - 180°.

Antes de la colocación siempre recomendamos desembalar varias cajas y probar a colocar el material en la composición elegida en los catálogos de RAKO en las páginas de internet web www.rako.eu.

Se recomienda la colocación de todos los posibles elementos de la decoración incluso girar los individualmente entre sí 90° o 180°, para conseguir la composición deseada y equilibrada del pavimento o revestimiento.

výrobek / product	cm	mm	EN	ks/m ²	m ²	kg	brutto kg
dlaždice / floor tile	30x30	298x298x8	EN 14411:2016, annex G B1a GL	13	11	1,18	56,64
dlaždice / floor tile	30x15	148x298x8	EN 14411:2016, annex G B1a GL	16	22	0,72	51,84
mozaika set 30x30 cm / mosaic sheet 30x30 cm	5x5	48x48x8	STO č. 030 - 049913	3	11	0,27	-
dekor 21x37 cm / decor 21x37 cm	12/7	120/70x8	EN 14411:2016, annex G B1a GL	5	13,1	0,38	-



DAR34710
PEI 5 ○ 74 / m²
mat | matt



DAR34711
PEI 4 ○ 74 / m²
mat | matt



DAR34712
PEI 4 ○ 74 / m²
mat | matt



DAR34713
PEI 4 ○ 74 / m²
mat | matt



DARJH710
PEI 5 ○ 84 / m²
mat | matt



DARJH711
PEI 4 ○ 84 / m²
mat | matt



DARJH712
PEI 4 ○ 84 / m²
mat | matt



DARJH713
PEI 4 ○ 84 / m²
mat | matt



DDM05710 (SET)
PEI 5 ○ 72 / set
mat | matt



DDM05711 (SET)
PEI 4 ○ 72 / set
mat | matt

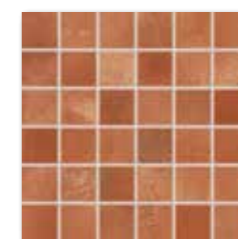

DDM05712 (SET)
PEI 4 ○ 72 / set
mat | matt



DDM05713 (SET)
PEI 4 ○ 72 / set
mat | matt



DDVT8710 (SET)
PEI 5 ○ 74 / set
mat | matt

světle béžová / light beige / jasnobežowa
светло-бежевый / világosbézs / beige claro



DDVT8711 (SET)
PEI 4 ○ 74 / set
mat | matt

šedá / grey / szara / серый / szürke / gris



DDVT8712 (SET)
PEI 4 ○ 74 / set
mat | matt

červeno-hnědá / red-brown / czerwono-brązowy
красно-коричневый / vörösesbarna / de color marrón rojizo



DDVT8713 (SET)
PEI 4 ○ 74 / set
mat | matt

hnědá / brown / brązowa / коричневый
barna / marrón

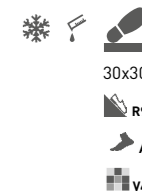

Doporučené sklady formátů viz str. 325. | Recommended combinations of modular sizes see page 325. | Zalecane ułożenie modułowych formatów na stronie 325. |
Рекомендуемый состав модульных форматов, см. стр. 325. | Composiciones de formatos recomendadas - vea la página nº 325.



DAR3B700
PEI 5 \odot 68 / m²
mat | matt

bílá / white / biata / белый / fehér / blanco



DAR3B702
PEI 5 \odot 68 / m²
mat | matt

běžovo-šedá / beige-grey / beżowo-szary
бежевый-серый / bézs-szürke / beige-gris



DAR3B701
PEI 5 \odot 68 / m²
mat | matt

vícebarevná / multicoloured / kolorowa
многоцветный / többszínű / multicolor



DAR3B703
PEI 5 \odot 68 / m²
mat | matt

červeno-hnědá / red-brown / czerwono-brązowy
красно-коричневый / vörösesbarna
de color marrón rojizo

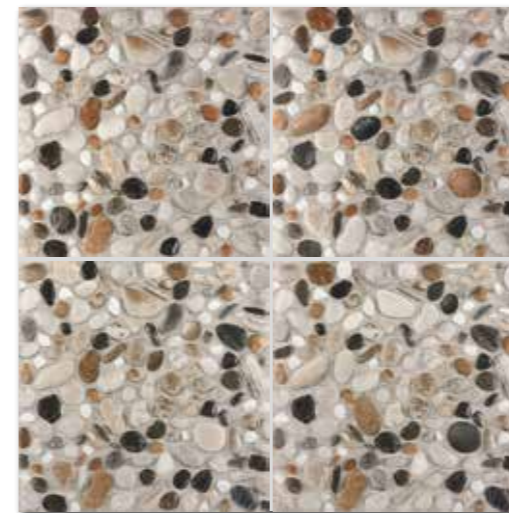

Doporučená spárovací hmota RAKO SYSTEM GF DRY 121 (manhattan)
Recommended grout RAKO SYSTEM GF DRY 121 (manhattan)

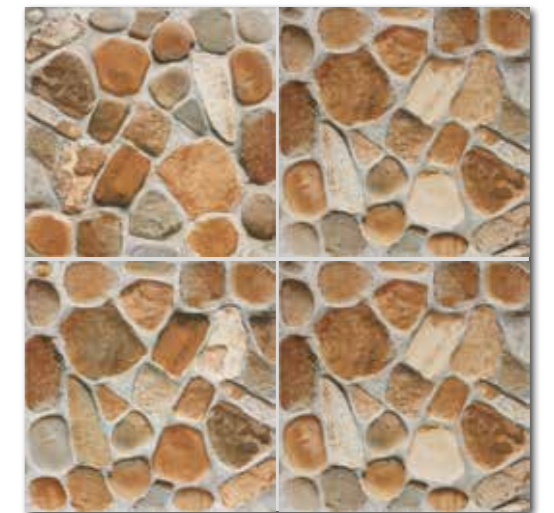

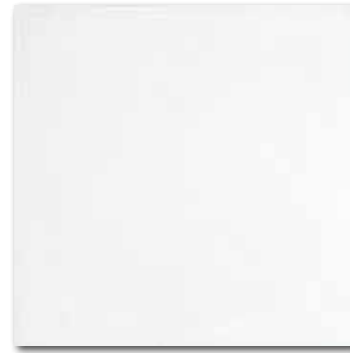

DAA44599
PEI 4 ○ 76 / m²
mat | matt



DAA44600
PEI 4 ○ 76 / m²
mat | matt



DAA44601
PEI 3 ○ 76 / m²
mat | matt



DAA44602
PEI 4 ○ 76 / m²
mat | matt



DAA44603
PEI 3 ○ 76 / m²
mat | matt

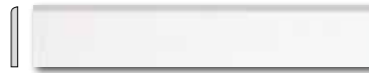

DSAPM599
○ 46 / ks
mat | matt



DSAPM600
○ 46 / ks
mat | matt



DSAPM601
○ 46 / ks
mat | matt



DSAPM602
○ 46 / ks
mat | matt



DSAPM603
○ 46 / ks
mat | matt

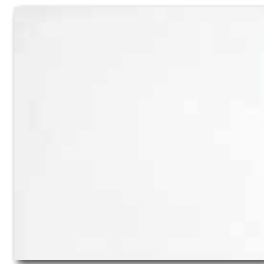

DAA3B599
PEI 4 ○ 76 / m²
mat | matt



DAA3B600
PEI 4 ○ 76 / m²
mat | matt



DAA3B601
PEI 3 ○ 76 / m²
mat | matt



DAA3B602
PEI 4 ○ 76 / m²
mat | matt



DAA3B603
PEI 3 ○ 76 / m²
mat | matt



DSAL3599
○ 32 / ks
mat | matt

bílá / white / biata / белый / fehér / blanco



DSAL3600
○ 32 / ks
mat | matt

běžová / beige / beżowa
бежевый / bézs / beige



DSAL3601
○ 32 / ks
mat | matt

hnědá / brown / brązowa
коричневый / barna / marrón



DSAL3602
○ 32 / ks
mat | matt

šedá / grey / szara / серый / szürke / gris



DSAL3603
○ 32 / ks
mat | matt

černá / black / czarna
черный / fekete / negro

výrobek / product



EN



ks/m²



m²



m²



kg



kg/m²



brutto kg

dlaždice / floor tile	45x45	448x448x10	EN 14411:2016, annex G Bla GL	6	5	1,21	26	31,46	25,0	20,7	677
sokl / skirting plinth	45x8	448x80x10	STO č. 030 - 049916	30	28	1,07	-	-	22,1	20,1	-
sokl / skirting plinth	45x8,5	448x85x10	STO č. 030 - 049916	20	26,1	0,77	-	-	15,9	20,7	-
dlaždice / floor tile	33x33	333x333x8	EN 14411:2016, annex G Bla GL	12	9	1,33	44	58,52	23,6	17,7	1 061
sokl / skirting plinth	33x8	333x80x8	STO č. 030 - 049916	27	38	0,71	-	-	12,6	17,7	-
sokl / skirting plinth	33x8	333x80x8	STO č. 030 - 049916	30	37,5	0,80	-	-	14,2	17,7	-



30x60
R10
A
V3



DARS A030
PEI 5 \odot 76 / m²
mat | matt



DARS A035
PEI 5 \odot 76 / m²
mat | matt



DARS A034
PEI 5 \odot 76 / m²
mat | matt



DARS A037
PEI 5 \odot 76 / m²
mat | matt

30x30

R10
A
V3



DAR 35030
PEI 5 \odot 72 / m²
mat | matt

slonová kost / ivory / kość stoniowa
слоновая кость / elefántcsont / marfil



DAR 35035
PEI 5 \odot 72 / m²
mat | matt

běžová / beige / bežowa
бежевый / bézs / beige



DAR 35034
PEI 5 \odot 72 / m²
mat | matt

okrová / ochre / ochrowa
охра / okker / ocse



DAR 35037
PEI 5 \odot 72 / m²
mat | matt

hnědá / brown / brązowa
коричневый / barna / marrón

30x30

30x7,5



SDM J35009
PEI 5 \odot 102 / ks
mat | matt



SDM J9009
PEI 5 \odot 78 / ks
mat | matt

slonová kost / ivory / kość stoniowa
слоновая кость / elefántcsont / marfil



SDM J9010
PEI 5 \odot 78 / ks
mat | matt

hnědá / brown / brązowa
коричневый / barna / marrón



30x60
R10
A
V3



DCP SE030
PEI 5 \odot 72 / ks
mat | matt

slonová kost / ivory / kość stoniowa
слоновая кость / elefántcsont / marfil



DCP SE035
PEI 5 \odot 72 / ks
mat | matt

běžová / beige / bežowa
бежевый / bézs / beige



DCP SE034
PEI 5 \odot 72 / ks
mat | matt

okrová / ochre / ochrowa
охра / okker / ocse



DCP SE037
PEI 5 \odot 72 / ks
mat | matt

hnědá / brown / brązowa
коричневый / barna / marrón



DCA 35030
DCP 35030
PEI 5 \odot 44 / ks
mat | matt



DCP 35035
PEI 5 \odot 44 / ks
mat | matt



DCP 35034
PEI 5 \odot 44 / ks
mat | matt



DCA 35037
DCP 35037
PEI 5 \odot 44 / ks
mat | matt

30x30
R10
A
V3



DSA J8030
 \odot 38 / ks
mat | matt



DSA J8035
 \odot 38 / ks
mat | matt



DSA J8034
 \odot 38 / ks
mat | matt



DSA J8037
 \odot 38 / ks
mat | matt

30x7,2



DCF JH030
PEI 5 \odot 66 / ks
mat | matt

slonová kost / ivory / kość stoniowa
слоновая кость / elefántcsont / marfil



DCF JH035
PEI 5 \odot 66 / ks
mat | matt

běžová / beige / bežowa
бежевый / bézs / beige



DCF JH034
PEI 5 \odot 66 / ks
mat | matt

okrová / ochre / ochrowa
охра / okker / ocse



DCF JH037
PEI 5 \odot 66 / ks
mat | matt

hnědá / brown / brązowa
коричневый / barna / marrón

30x15
R10
A
V3

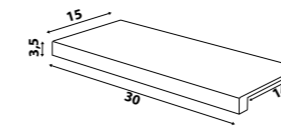

výrobek / product	mm	mm	EN	ks/m ²	m ²	m ²	kg	kg/m ²	brutto kg		
dlaždice / floor tile	30x60	303x602x10	EN 14411:2016, annex G Bla GL	6	5,6	1,08	40	43,20	24,0	22,2	985
dlaždice / floor tile	30x30	298x298x8	EN 14411:2016, annex G Bla GL	13	11	1,18	48	56,64	21,0	17,8	1 034
schodovka / step tile	30x60	303x602x10	STO E. 030 - 049916	6	5,6	1,08	40	-	24,0	22,2	-
schodovka / step tile (DCA...)	30x30	298x298x8	STO E. 030 - 049916	13	11	1,18	48	-	21,0	17,8	-
schodovka / step tile (DCP...)	30x30	298x298x8	STO E. 030 - 049916	13	11	1,18	52	-	21,0	17,8	-
sokl / skirting plinth	30x7,2	298x72x8	STO E. 030 - 049916	30	46,3	0,65	-	-	11,6	17,8	-
balkónová tvarovka / balcony L-shape	30x15	298x150x8	STO E. 030 - 049916	6	22	0,27	48	12,96	7,2	26,7	376
inzerto - kamenná mozaika / insert - stone mosaic	30x30	298x298x8	EN 1469:2015	4	11	0,36	-	-	6,9	19,2	-
bordura - kamenná mozaika / floor tile listel - stone mosaic	30x7,5	298x75x8	EN 1469:2015	10	44	0,23	-	-	4,3	19,2	-

Všechny výrobky celé série vykazují velké odchylky odstínové difference V3. / All products of the entire batch show big deviations in shade difference V3. / Wszystkie produkty w tej serii wykazują znaczne różnice odcieni V3. / Для всей плитки данной серии характерно значительное отличие оттенков V3. / A termékszalát elemei jeletős színárnyalatbeli eltérést mutathatnak. / Todos los productos de la serie muestran grandes desviaciones en la diferencia de la tonalidad V3.

serie pietra di mare



serie pietra di mare



DAA3B416
PEI 4 ○ 66 / m²
mat | matt



DAA3B418
PEI 4 ○ 66 / m²
mat | matt



DCP3B416
PEI 4 ○ 44 / ks
mat | matt



DCP3B418
PEI 4 ○ 44 / ks
mat | matt



DSAL3416
○ 38 / ks
mat | matt

běžová / beige / beżowa / бежевый
bézs / beige



DSAL3418
○ 38 / ks
mat | matt

hnědá / brown / brązowa / коричневый
barna / marrón



výrobek / product



výrobek / product	mm	mm	EN	ks/m ²	m ²	m ²	kg	kg/m ²	brutto kg		
dlaždice / floor tile	33x33	330x330x7,5	EN 14411:2016, annex G B1a GL	15	9,2	1,63	42	68,46	26,1	16,0	1 121
schodovka / step tile	33x33	330x330x7,5	STO č. 030 - 049916	12	9,2	1,31	-	-	21,0	16,0	-
sokl / skirting plinth	33x8	330x80x7,5	STO č. 030 - 049916	30	37,9	0,80	-	-	12,8	16,0	-

serie classic



15x15

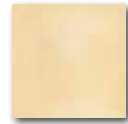

WAA1B350
○ 68 / m²
mat | matt

15x15
45x15



WIT1B261
○ 28 / ks
mat | matt



WIT1B259
○ 28 / ks
mat | matt



WIT1B260
○ 28 / ks
mat | matt



WITP2001 (SET)
○ 52 / set
mat | matt

15x2



WLRC2010
○ 38 / ks
mat | matt

30x30



WIT32258 (SET)
○ 52 / set
mat | matt

45x30



WIT1B043 (SET)
○ 78 / set
mat | matt



WITP4035 (SET)
○ 76 / set
mat | matt



WITP4042 (SET)
○ 76 / set
mat | matt



30x30



DAR34713
Via
PEI 4 ○ 74 / m²
mat | matt
hnědá / brown / brązowa / коричневый
barna / marrón

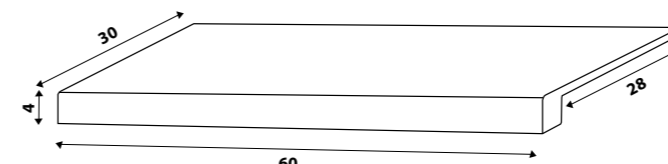

30x60 (Rock, Stones) 60
průběžná / continuous / bieżaca
непрерывный элемент / folymatos

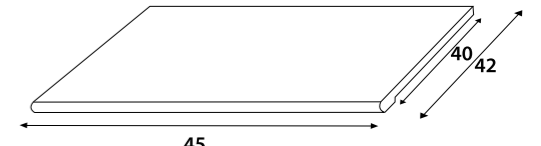

45x42 (Defile)
průběžná / continuous / bieżaca
непрерывный элемент / folymatos

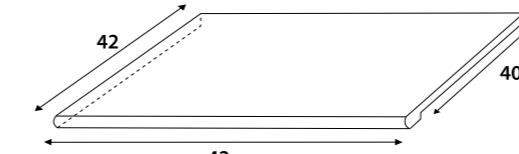

42x42 (Defile)
roh levý / left corner / róg lewy
левый угол / bal sarok

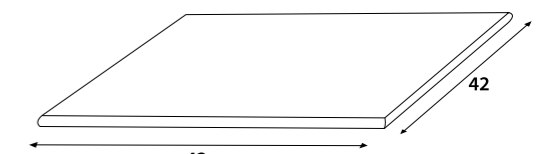

42x42 (Defile)
roh pravý / right corner / róg prawy
правый угол / jobb sarok

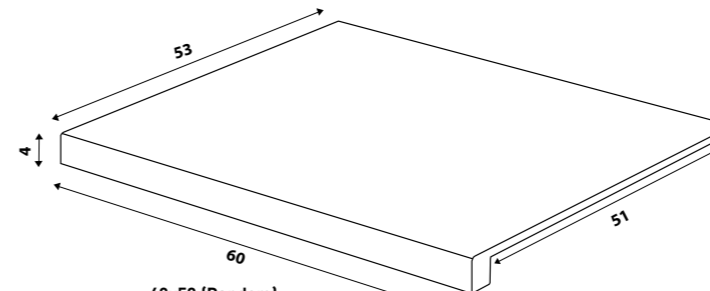

60x53 (Random)
průběžná / continuous / bieżaca
непрерывный элемент / folymatos

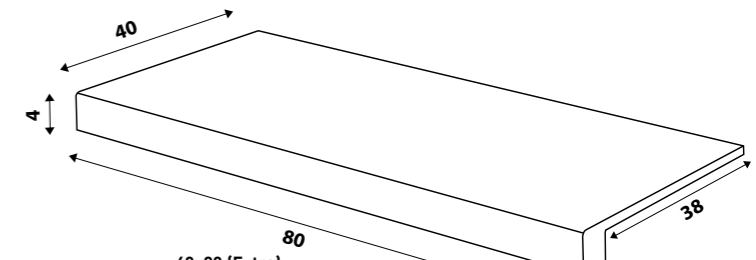

40x80 (Extra)
průběžná / continuous / bieżaca
непрерывный элемент / folymatos

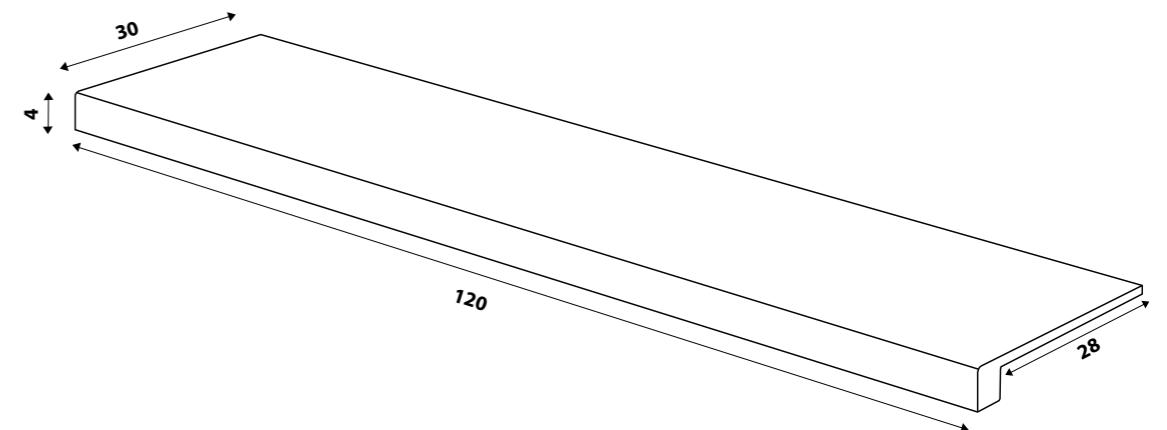

120x30 (Board)
průběžná / continuous / bieżaca
непрерывный элемент / folymatos

výrobek / product	cm	mm	EN	ks/m ²	m ²	m ²	kg	kg/m ²	brutto kg	
obkládačka / wall tile	15x15	150x150x6	EN 14411:2016, annex L BIII GL	44	44	1,00	100	100,00	10,5	1 075
inzerťo / insert	15x15	150x150x6	EN 14411:2016, annex L BIII GL	4	44	0,09	-	-	1,0	10,5
inzerťo / insert (set)	45x15	450x150x6	EN 14411:2016, annex L BIII GL	2	44	0,14	-	-	1,6	11,7
reliefní listy / relief listel	15x2	150x20	STO č. 030 - 054498	24	333	0,07	-	-	1,3	17,7
inzerťo / insert (set)	30x30	300x300x6	EN 14411:2016, annex L BIII GL	1	44	0,09	-	-	1,0	10,5
inzerťo / insert (set)	45x30	450x300x6	EN 14411:2016, annex L BIII GL	1	44	0,14	-	-	1,4	10,5
dlaždice / floor tile	33x33	333x333x8	EN 14411:2016, annex G BIIa GL	12	9	1,33	44	58,52	23,6	1 061

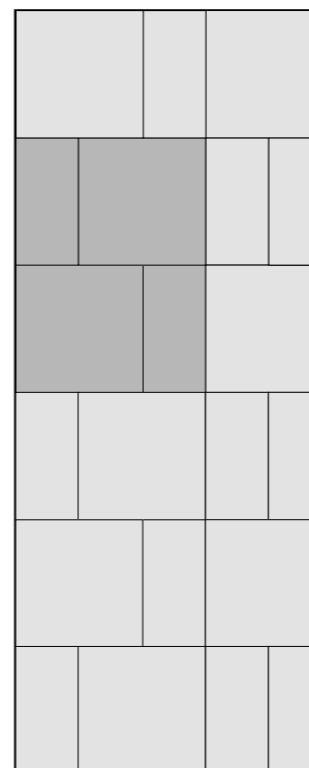

60x60 = 66,7%, 30x60 = 33,3%
 Alba Pietra
 Base Rock
 Cemento Sandstone Plus
 Clay Stones
 Extra Trend
 Kaamos Unistone
 80x80 = 66,7%, 40x80 = 33,3%
 Extra
 30x30 = 66,7%, 15x30 = 33,3%
 Via

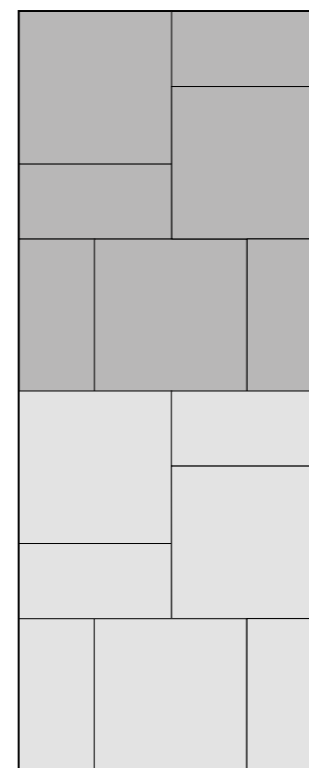

60x60 = 60%, 30x60 = 40%
 Alba Pietra
 Base Rock
 Cemento Sandstone Plus
 Clay Stones
 Extra Trend
 Kaamos Unistone
 80x80 = 60%, 40x80 = 40%
 Extra
 30x30 = 60%, 15x30 = 40%
 Via

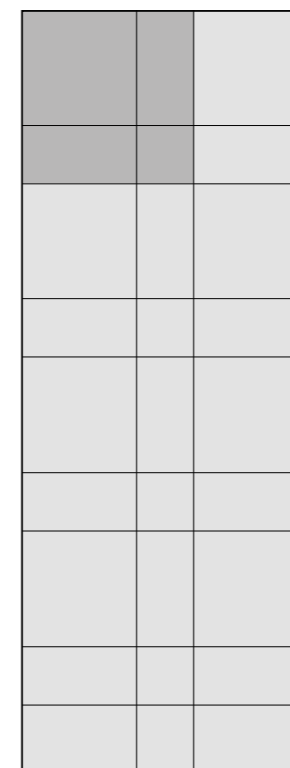

45x45 = 45%, 22,5x45 = 45%,
 22,5x22,5 = 10%
 Siena

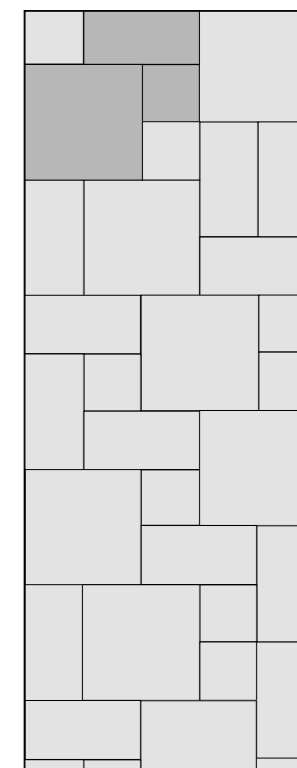

45x45 = 57%, 22,5x45 = 29%,
 22,5x22,5 = 14%
 Siena

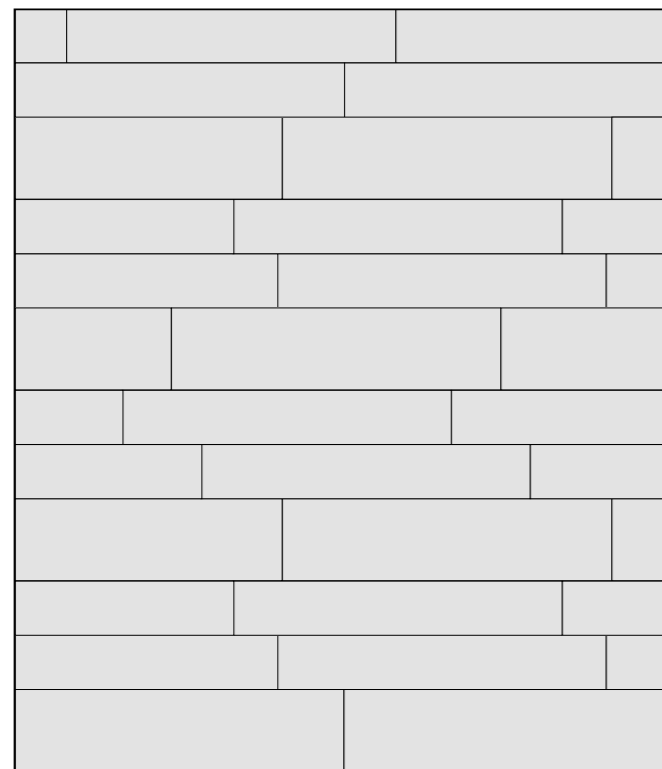

20x120, 30x120
 Board

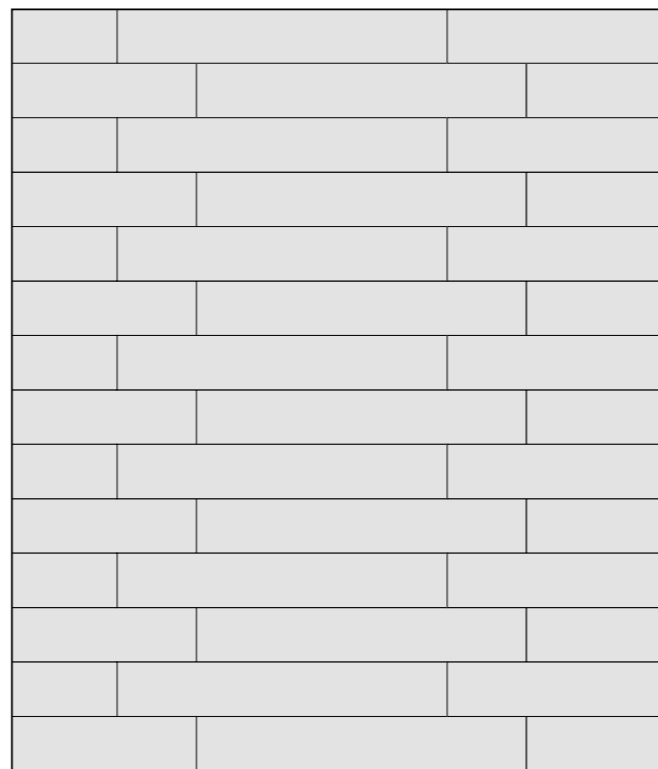

20x120
 Board

15x60
 Faro

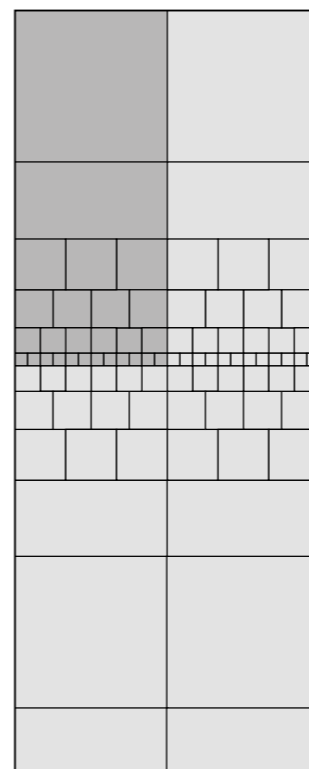

60x60 = 42,9%, 30x60 = 21,4%,
 20x20 = 14,3%, 15x15 = 10,7%,
 10x10 = 7,1%, 5x5 = 3,6%
 Rock
 Unistone

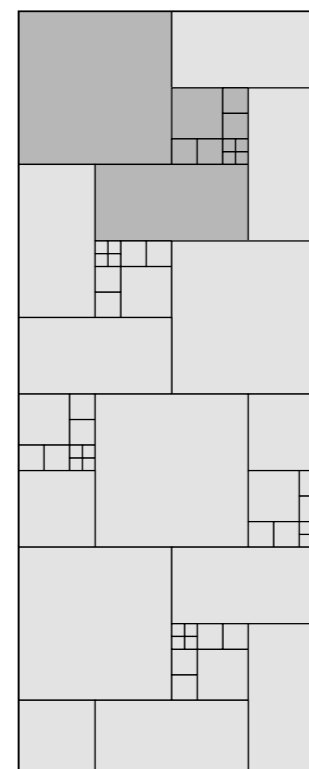

60x60 = 57,1%, 30x60 = 28,6%,
 20x20 = 6,3%, 10x10 = 6,3%,
 5x5 = 1,7%
 Extra
 Rock
 Unistone

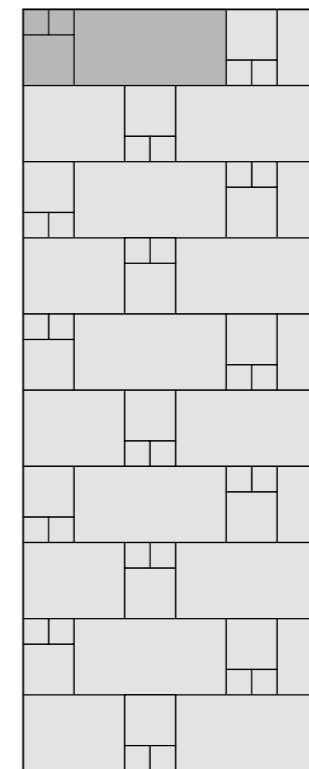

30x60 = 75%, 20x20 = 16,7%,
 10x10 = 8,3%
 Extra
 Rock
 Unistone

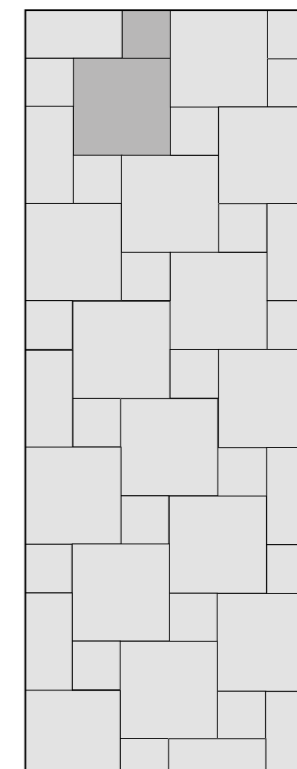

45x45 = 80%, 22,5x22,5 = 20%
 Siena

Systém značení a doporučené použití keramických obkladových prvků RAKO | RAKO ceramic tiles and accessories – identification system and application recommendations | System oznaczania i zalecane użycie płytek ceramicznych RAKO | Система маркировки и рекомендуемое применение керамических облицовочных элементов RAKO

Systém značení a doporučené použití keramických obkladových prvků RAKO | RAKO ceramic tiles and accessories – identification system and application recommendations | System oznaczania i zalecane użycie płytek ceramicznych RAKO | Система маркировки и рекомендуемое применение керамических облицовочных элементов RAKO

CZ Doporučené použití nabízených typů keramických obkladových prvků:

Vysoce slinuté neglazované dlaždice TAURUS, katalogové číslo: Txxxxxxx, jsou keramické vysoce slinuté neglazované mrazuvzdorné obkladové prvky s velmi nízkou nasákavostí menší nebo rovnající se 0,5 %, vyráběné podle EN 14411:2016 Bla UGL, příloha G. Výrobky jsou určeny především k obkladům podlah v exteriérech a interiérech, které jsou vystaveny povětrnostním vlivům a vysokému až extrémnímu mechanickému namáhání, obrusu a znečištění. Z tohoto důvodu jsou velice vhodné pro podlahy v restauracích, správních budovách, autosalonech, potravinářských a chemických provozech a pro venkovní vodorovné plochy balkonů, teras a pasáží. Vyznačují se vysokou pevností, mrazuvzdorností a chemickou odolností. Leštěné neglazované dlaždice jsou určeny pro exkluzivní interiéry a fasády.

Slinuté neglazované dlaždice TAURUS jsou vyráběny v jednobarevném i vícebarevném provedení s reliéfním protiskluzným, standardním hladkým nebo leštěným povrchem. Hmotu materiálu (střep) se probarvuje, čímž se nahrazuje estetická funkce glazury. Tím vytváříme samotný design povrchu. Povrchy s deklarovanou protiskluzností je třeba používat pro podlahy s nebezpečím uklouznutí podle příslušných předpisů. Velkoformátové dlaždice (30 x 60 a 60 x 60 cm) a leštěné dlaždice jsou rektifikovány na přesný rozměr umožňující precizní pokládku a kombinaci formátů. Obkladové prvky ze série TAURUS INDUSTRIAL jsou vyráběny i v zesílené tloušťce 15 mm pro velmi silně zatížené podlahy v průmyslových provozech, (např. dílny, výrobní provozy a sklady).

Vysoce slinuté glazované dlaždice KENTAUR, katalogové číslo: Dxxxxxxx, jsou vysoce slinuté keramické glazované mrazuvzdorné obkladové prvky s velmi nízkou nasákavostí menší nebo rovnající se 0,5 %, vyráběné podle EN 14 411:2016 Bla GL, příloha G. Výrobky mají univerzální použití jako dlažba i obklad interiéru a exteriéru, kde jsou vystaveny povětrnostním vlivům, vysokému mechanickému namáhání i znečištění. Z tohoto důvodu jsou velmi vhodné pro použití v bytech a bytových domech i v exteriéru na terasách a balkonech. Ve veřejných objektech (např. v restauracích, prodejnách, hotelech, úřadech, autosalonech) je třeba použít dlaždice s otěruvzdorností PEI 5 a předepsanou protiskluzností. Slinuté glazované dlaždice KENTAUR jsou vyráběny v mnoha barevných, designových a povrchových provedeních (hladké, reliéfní, protiskluzné, lapované atd.). Hmotu materiálu (střep) se u některých výrobců probarvuje, abychom sladili barvu hmoty s glazurou tam, kde se frézují do hmoty protiskluzné drážky, nebo např. při broušení kulatých nášlapných hran u schodovek. Velkoformátové dlažby (30 x 60, 60 x 60, 40 x 80, 80 x 80, 20 x 120 a 30 x 120 cm) jsou rektifikovány na přesný rozměr umožňující precizní pokládku a kombinaci formátů.

Glazované hutné dlaždice, katalogové číslo: Gxxxxxxx, jsou keramické glazované obkladové prvky s nasákavostí větší než 0,5 % a menší nebo rovnající se 3,0 %, vyráběné podle EN 14411:2016 Blb GL, příloha H.

Dlaždice lze použít k obkladům vnitřních podlah a stěn včetně venkovních fasád, které jsou vystaveny povětrnostním vlivům. Příkladem jejich univerzálního použití jsou podlahy i stěny koupelen, kuchyní, chodeb, kanceláří, vnějších fasád, saun, sprch, bazénů a veřejných budov, mrazíren a potravinářských provozů atd. **Tyto dlaždice nejsou určeny pro vodorovné plochy balkonů a teras. Sortiment POOL má nasákavost pod 1 %, je mrazuvzdorný a vhodný pro sprchy a bazény v exteriérech.**

Dlaždice jsou vyráběny v široké barevné škále s lesklým i matným povrchem, zdobeným různými technikami (tisk, sypaní, přístřik), případně s glazurou nebo reliéfem v protiskluzném provedení. Dlaždice s povrchem ze zlata, platiny a perleti lze použít pouze na stěny v interiéru!

Obkládačky, katalogové číslo: Wxxxxxxx, jsou glazované keramické obkladové prvky s nasákavostí větší než 10 %, vyráběné podle EN 14411:2016 Blil GL, příloha L. Jsou určeny pro obklady stěn v interiérech, které nejsou vystaveny povětrnostním vlivům, mrazu, trvalým účinkům vody, kyselinám a louhům, jejich výparům a působení abrazivních prostředků. Proto se používají k obkladům stěn koupelen, kuchyní, prádelny a ostatních interiéru. **V prostředí, kde bude pórovinná obkládačka vystavena přímému působení vody, ve sprchovém koutě apod., je nutné použít spárovací hmotu typu CG2WA se sníženou nasákavostí.** Povrch obkládaček je hladký nebo jemně reliéfní, s lesklou, polomatnou či matnou glazurou v jednobarevném, případně vícebarevném provedení, nebo zdobený různými technikami (digitální tisk, rotocolor). V závislosti na použitém typu glazury (transparentní, polotransparentní) nelze vyloučit, že může dojít k přechodnému tmavému zbarvení obkladu podminěným jeho konstrukci, které je způsobeno pronikáním vlhkosti do střepu obkládačky. Zbarvení může být navíc podpořeno vodopropustností spár, izolačními vrstvami v podkladu (voda zůstane uzavřena mezi izolační vrstvou a glazurou) a vysokou vlhkostí vzduchu v koupelnách s nedostatečným odvětráním. Toto dočasné zbarvení však nepředstavuje vadu výrobku. Velkoformátové obkládačky (30 x 60 a 30 x 90 cm) jsou vyráběny i v rektifikovaném provedení, které umožňuje precizní pokládku na minimální spáru.

Doplňkové nekeramické materiály – sklo s katalogovým číslem Vxxxxxxx, přírodní kamenivo s katalogovým číslem Sxxxxxxx, jsou vhodným unikátním doplňkem keramických obkladů. Vlastnosti těchto materiálů a charakteristické rozdíly v barvě, struktuře a dalších atributech jsou dány technologií výroby nebo jejich přírodním původem.

Slinuté glazované tažené dlaždice a tvarovky POOL, katalogové číslo: XPxxxxxx, jsou vysoce slinuté keramické glazované mrazuvzdorné prvky s velmi nízkou nasákavostí pod 0,5 %, vyráběné tažením podle EN 14411:2016 Ala GL, příloha M. Jsou vhodné pro profesionální řešení okrajů veřejných i soukromých bazénů v interiérech a exteriérech.

Označení výrobků – výrobní šarže

Všechny keramické obkladové prvky jsou vyráběny v dávkách – šaržích, které se navzájem mohou lišit barevným odstínem a rozměrem. Jednotlivé šarže jsou označeny v průvodní dokumentaci, na paletách a v dodacích listech. Na obalech, kromě katalogového čísla, názvu série a druhu povrchu, je označen odstín, deklarovaný rozměr, jakost, popř. otěruvzdornost a protiskluznost glazovaných dlaždic.

Obkladové prvky jednotlivých šarží s odlišně označeným barevným odstínem šarže nebo odlišným deklarovaným rozměrem nesmí být použity na jednu plochu. Barevný odstín je na kartonech vyznačen kombinací dvou nebo tří písmen a číslic, rozměr je uveden číselným kódem, viz obr. 1, 2, tabulka s deklarovaným rozměrem W, mm.

Obr. 1 **Karton pro glazované dlaždice**



barevný odstín kód rozměru v mm jakost otěruvzdornost

Obr. 2 **Karton pro neglazované dlaždice**



barevný odstín kód rozměru v mm jakost

Návěští pro glazované obklady a dlaždice

COBJ.WAAKB104.RA.1				
SYSTEM			Size / Rozměr: 25x33 cm	
matt / mat			Pallet: 54 boxes 81,000 M2	
Plant / Závod	Line, shade / Linka, odstín	Size/velikost	PAL	EAN
C223	4	LE 0	A	E

barevný odstín kód rozměru v mm jmenovitý rozměr

Návěští pro neglazované dlaždice

CGRA.TAA35065.LB.1				
TAURUS GRANIT			Size / Rozměr: 30x30 cm	
standard / standardní			Pallet: 52 boxes 52,000 M2	
Plant / Závod	Line, shade / Linka, odstín	Size/velikost	PAL	EAN
C231	8	L8	9	A E

barevný odstín kód rozměru v mm jmenovitý rozměr

Před zahájením kladečských prací je třeba ověřit údaje na obalech. Kombinace obkladových prvků s různým katalogovým číslem v jedné ploše je třeba předem projednat a písemně objednat u dodavatele nebo prodejce.

Certifikace a prohlášení o vlastnostech

Ověřování stálosti vlastností typů keramických obkladových prvků provedeno podle Nařízení Evropského parlamentu a Rady EU č. 305/2011 ze dne 9. 3. 2011, systém posouzení 4:

Prohlášení o vlastnostech T13 01 – slinuté neglazované dlaždice Bla
Prohlášení o vlastnostech D13 01 – slinuté glazované dlaždice Bla
Prohlášení o vlastnostech G13 01 – hutné glazované dlaždice Blb
Prohlášení o vlastnostech W13 01 – glazované obkládačky Blil
Prohlášení o shodě P 01 – Mozaika pro obklady stěn a podlah (nařízení vlády č. 163/2002 Sb., ve znění NV č. 312/2005 Sb.)
Prohlášení o shodě P 02 – Keramické tvarovky, schodovky atd. (nařízení vlády č. 163/2002 Sb., ve znění NV č. 312/2005 Sb.)
Prohlášení o shodě P 03 – Výrobky z přírodního kamene
Prohlášení o shodě P 04 – Keramické reliéfní listy a keramické doplňky (nařízení vlády č. 163/2002 Sb., ve znění NV č. 312/2005 Sb.)
 Prohlášení výrobce jsou k dispozici v různých jazykových verzích na www.rako.eu (<http://www.rako.cz/ke-stazeni/prohlaseni.html> popř. <http://www.rako.cz/en/download/declarations.html>, <http://www.rako.cz/de/download/erklarungen.html>).

EN Recommended use of available types of ceramic tiles:

TAURUS fully vitrified unglazed floor tiles, Catalogue No.: Txxxxxxx
 Fully vitrified unglazed frost-resistant ceramic tiles with very low water absorption less than or equal 0.5%, made in compliance with EN 14411:2016 Bla UGL, Annex G.

The products are intended mainly for floor tiling in exteriors and interiors exposed to climatic effects and subject to extreme mechanical stress, abrasion and pollution. For this reason, they are particularly suitable for floors in restaurants, administrative buildings, car showrooms, food processing and chemical plants, as well as outdoor horizontal surfaces of balconies, terraces, and passageways. They are characterized by high strength, frost and chemical resistance. The polished unglazed tiles are designed for exclusive interiors and facades.

The vitrified unglazed TAURUS tiles are offered in monochrome as well as multicolour variants with anti-slip relief, standard smooth or polished surface. The material mass (body) can be coloured, thus replacing the aesthetic function of a glaze. In this way, we create the actual surface design. The tiles with declared anti-slip surface finish must be used for floors with the risk of slipping pursuant to the applicable regulations. Large tiles (30 x 60 and 60 x 60 cm) and polished tiles are rectified for accurate dimensions allowing for precise laying and format combinations. TAURUS INDUSTRIAL series tiles are thickened to 15 mm for heavily stressed floors in industrial operations (workshops, manufacturing halls and warehouses).

KENTAUR fully vitrified glazed floor tiles, Catalogue No.: Dxxxxxxx
 are fully vitrified ceramic glazed frost resistant tiles with very low water absorption less than or equal to 0.5%, manufactured to comply with EN 14411:2016 Bla GL, Annex G.

The products are of universal use as floor and wall tiles for interiors and exteriors, exposed to climatic effects, high mechanical stress and pollution. For this reason they are very suitable for apartments and apartment buildings, also for the exterior in terraces and balconies. Ceramic tiles with the abrasion resistance PEI 5 and declared slip resistance are particularly suitable for public buildings (e.g. restaurants, shops, hotels, offices, governmental buildings, car showrooms). The vitrified glazed KENTAUR tiles are available in many colours and designs and surface finishes (smooth, relief, anti-slip, lapped etc.). The material mass (body) is in some products coloured in order to match the colour of the mass with the glaze where anti-slip grooves are milled in the body or, for example, during grinding of the round step edges of the step tiles. Large size tiles (30 x 60, 60 x 60, 40 x 80, 80 x 80, 20 x 120 and 30 x 120 cm) are rectified for accurate dimensions allowing for precise laying and format combinations.

Compact glazed floor tiles, Catalogue No.: Gxxxxxxx
 are glazed ceramic tiles with water absorption higher than 0.5% and less than or equal to 3.0%, made in compliance with EN 14411:2016 Blb GL, Annex H.

These tiles can be used for interior floors and walls including exterior façades which are exposed to the weather. An example of their application is their universal use on floors and walls of bathrooms, kitchens, passages, offices, exterior façades, swimming pools in interiors, saunas, deep freeze rooms, food processing plants, etc. **These tiles are not intended for horizontal surfaces on balconies and terraces. Water absorption of the POOL tiles is under 1 %, they are frost resistant and suitable for showers and exterior pools.**

The tiles are made in a wide range of colours with glossy and matt finish, decorated with various technique (printing, dusting, spraying) or with a glaze or relief for anti-slip use. Tiles with the gold, platinum and mother-of-pearl surface can be used only for interior walls!

Wall tiles, catalogue number: Wxxxxxxx
 are ceramic glazed wall tiles with water absorption higher than 10%, made in compliance with EN 14411:2016 Blil GL, Annex L. They are designed for tiling of interior walls and not suitable for exposure to climatic effects, frost, underground water, acids and alkali, their vapours and abrasive detergents.

System značení a doporučené použití keramických obkladových prvků RAKO | RAKO ceramic tiles and accessories – identification system and application recommendations | System oznaczania i zalecane użycie płytek ceramicznych RAKO | Система маркировки и рекомендуемое применение керамических облицовочных элементов RAKO

They are thus used for tiling walls of bathrooms, kitchens, laundries or other interiors. **In an environment where the wall tile will be exposed to the direct action of water, in a shower enclosure etc., it is necessary to use a CG2WA type grouting material with reduced water absorption.** The tile surface is smooth or embossed, with glossy, semi-matt or matt glaze, namely transparent, semi-transparent, or non-transparent, plain- or multi-coloured, or decorated with various techniques (digital print, Rotocolor). Depending on the used glaze type (transparent, semi-transparent) transient dark colouring of the tile cannot be excluded, as it is determined by its structure and caused by humidity infiltration in the tile. The colouring may further be supported with water permeability of the joints, insulation layers in the base (water is held between the insulation layer and the glaze) and high air humidity in bathrooms with insufficient ventilation. This transient colouring does not represent a defect of the product. Large-format wall tiles (30 x 60 and 30 x 90 cm) are manufactured also in a rectified design, enabling precise laying with a minimum joint.

Non-ceramic accessory materials – glass of Catalogue No. Vxxxxxxx, natural stone of Catalogue No. Sxxxxxxx
 Unique accessory materials complementing ceramic wall tiles. Properties of these materials and their characteristic differences in colour, structure and other properties are determined by the production technology or by their natural origin.

POOL sintered drawn floor tiles and shapes, Catalogue No.: XPxxxxxx
 Highly sintered glazed frost-resistant ceramic products with very low absorption less than or equal to 0.5%, made by a drawing technique in accordance with EN 14411:2016 Ala GL, Annex M, suitable for professional designs of edges of public as well private indoor and outdoor swimming pools.

Product identification - production batches

All ceramic tile products are made in batches which batches may differ from each other in colour shade and dimensions. The batches are identified in client documentation, on palettes and in delivery notes. In addition to the catalogue number, name of the series, and the type of surface, packages include identification of shade, declared dimensions, quality and, as applicable, abrasion and slip resistance properties of glazed floor tiles.

Tiles from batches with different colour shade identifier or different declared dimensions must not be used in the same surface. Colour shade is shown on cartons by a combination of two or three letters and numbers, dimensions are identified by a numeric code, see Fig. 1, 2, Table of declared dimension W in mm.

Fig.1 **Cardboard packaging for glazed tiles**

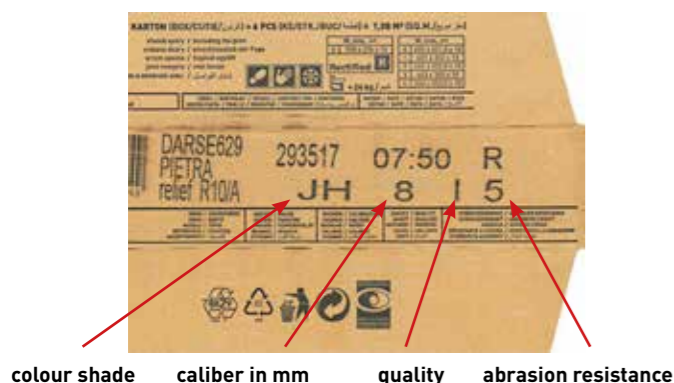
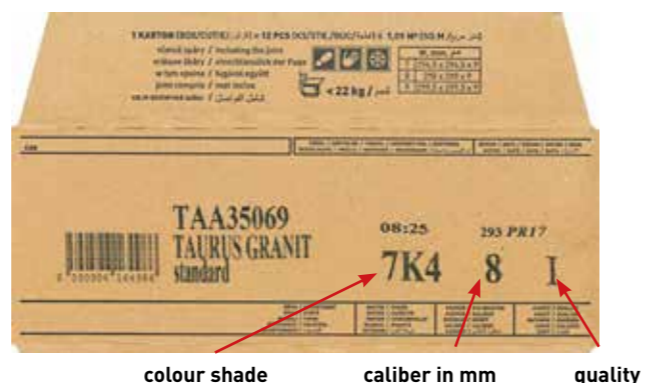

Fig.2 **Cardboard packaging for unglazed tiles**



Label for glazed wall and floor tiles

COBJ.WAAKB104.RA.1				
SYSTEM		Size / Rozměr: 25x33 cm		
matt / mat		Pallet: 54 boxes 81,000 M2		
Plant / Závod	Line, shade / Linka, odstín	Size/velikost	PAL	EAN
C223	4	LE	0	A E
colour shade	caliber in mm	nominal size		

This information must be checked on the packaging before fixing the tiles. Combinations of tiles of different catalogue numbers in the same surface should be discussed beforehand and ordered in writing from the supplier or dealer.

Label for unglazed floor tiles

CGRA.TAA35065.LB.1				
TAURUS GRANIT		Size / Rozměr: 30x30 cm		
standard / standardní		Pallet: 52 boxes 52,000 M2		
Plant / Závod	Line, shade / Linka, odstín	Size/velikost	PAL	EAN
C231	8	L8	9	A E
colour shade	caliber in mm	nominal size		

System značení a doporučené použití keramických obkladových prvků RAKO | RAKO ceramic tiles and accessories – identification system and application recommendations | System oznaczania i zalecane użycie płytek ceramicznych RAKO | Система маркировки и рекомендуемое применение керамических облицовочных элементов RAKO

Certificates and Declarations of Properties

Properties of ceramic tile products are tested in accordance with European Parliament and Council (EU) Regulation 305/2011 of 9 March 2011, Assessment System 4:

- Declaration of Properties T13 01 – sintered unglazed floor tiles BlA**
 - Declaration of Properties D13 01 – sintered glazed floor tiles BlA**
 - Declaration of Properties G13 01 – dense glazed floor tiles BlB**
 - Declaration of Properties W13 01 – glazed wall tiles BlII**
 - Declaration of Conformity P 01 – Mosaics for wall and floor tiles** (Government Decree No. 163/2002 in the wording of GD No. 312/2005)
 - Declaration of Conformity P 02 – Shaped ceramic bricks, step tiles, etc.** (Government Decree No. 163/2002 in the wording of GD No. 312/2005)
 - Declaration of Conformity P 03 – Natural stone products**
 - Declaration of Conformity P 04 – Ceramic relief listellos and ceramic accessories** (Government Decree No. 163/2002 in the wording of GD No. 312/2005)
- Manufacturer's declarations are available in various languages at www.rako.eu
<http://www.rako.cz/ke-stazeni/prohlaseni.html> or <http://www.rako.cz/en/download/declarations.html>,
<http://www.rako.cz/de/download/erklarungen.html>.

PL Zalecane przeznaczenie oferowanych typów płytek ceramicznych:

Wysokospiekane nieszkliwione płytki podłogowe TAURUS, numer katalogowy: Txxxxxxx
 są to ceramiczne wysokospiekane, nieszkliwione, mrozo odporne elementy okładzinowe o bardzo niskiej nasiąkliwości, mniejszej lub równej 0,5 %, produkowane według EN 14411:2016 BlA UGL, załącznik G.

Wyroby są przeznaczone przede wszystkim do wykonywania podłóg na zewnątrz i we wnętrzach, które są narażone na działanie czynników atmosferycznych i wysokie, do ekstremalnych obciążenia, ścieranie i zanieczyszczenie. Z tego powodu są zalecane do wykańczania podłóg w restauracjach, budynkach administracyjnych, salonach samochodowych, zakładach spożywczych i chemicznych, oraz poziomych powierzchni zewnętrznych balkonów, tarasów i pasaży. Cechuje je wysoka wytrzymałość, mrozo odporność i odporność chemiczna. Polerowane nieszkliwione płytki podłogowe są przeznaczone do ekskluzywnych wnętrz i na elewacje.

Spiekane nieszkliwione płytki podłogowe TAURUS są produkowane w wersji jednokolorowej i wielokolorowej z powierzchnią reliefową przeciwpoślizgową lub standardową gładką, oraz powierzchnią polerowaną. Masa ceramiczna (czerep) jest barwiona, zastępując estetyczne funkcje szkliwa. Tak uzyskujemy pożądaną zdobienie powierzchni. Powierzchnie o deklarowanej przeciwpoślizgowości są przeznaczone do wykańczania podłóg, gdzie występuje niebezpieczeństwo poślizgnięcia, stosownie do właściwych przepisów. Wielkoformatowe płytki podłogowe (30 x 60 i 60 x 60 cm) oraz płytki polerowane, są rektyfikowane do dokładnego wymiaru, umożliwiającego precyzyjne położenie i łączenie formatów. Płytki ceramiczne z serii TAURUS INDUSTRIAL są produkowane również w większej grubości, 15 mm z przeznaczeniem na mocno obciążone posadzki przemysłowe (np. warsztaty, hale produkcyjne, magazyny).

Wysokospiekane szklione płytki podłogowe typu KENTAUR, numer katalogowy: Dxxxxxxx
 są to wysokospiekane ceramiczne, szklione, mrozo odporne elementy o bardzo niskiej nasiąkliwości, mniejszej lub równej 0,5 %, produkowane według EN 14411:2016 BlA GL, załącznik G. Wyroby mają uniwersalne zastosowanie jako wykończenie podłóg lub ścian we wnętrzach i na zewnątrz, gdzie są narażone na działanie czynników atmosferycznych, wysokie obciążenia mechaniczne i zanieczyszczenie. Z tego powodu są bardzo wskazane do stosowania w mieszkaniach i domach mieszkalnych oraz na zewnątrz, na tarasach i balkonach. W obiektach użytku publicznego (np. w restauracjach, sklepach, hotelach, urzędach, salonach samochodowych) trzeba użyć płytek o odporności na ścieranie PEI 5 i deklarowanej przeciwpoślizgowości. Wysokospiekane, szklione płytki podłogowe KENTAUR są produkowane w wielu odmianach wzorniczych i kolorystycznych (gładkie, reliefowe, przeciwpoślizgowe, pół-polerowane). Masa ceramiczna (czerep), niektórych produktów jest barwiona aby uzyskać zgodność koloru czerepu ze szklivem tam, gdzie są frezowane przeciwpoślizgowe rowki, lub przykładowo szlifowane wyoblenia krawędzi stopnicy. Wielkoformatowe płytki podłogowe (30 x 60, 60 x 60, 40 x 80, 80 x 80, 20 x 120 i 30 x 120 cm) oraz płytki polerowane, są rektyfikowane do dokładnego wymiaru, umożliwiającego precyzyjne położenie i łączenie formatów.

Płytki podłogowe szklione, numer katalogowy: Gxxxxxxx
 są to ceramiczne szklione elementy okładzinowe o nasiąkliwości większej, niż 0,5% a mniejszej, lub równej 3,0%, produkowane według EN 14411:2016 BlB GL, załącznik H.

Płytki można stosować jako okładzinę podłóg i ścian we wnętrzach, oraz elewacji, które są narażone na działanie czynników atmosferycznych. Przykładem ich uniwersalnego zastosowania są podłogi i ściany łazienek, kuchni, korytarzy, biur, elewacje, baseny wewnętrzne, sauny, strefy natrysków, zamrażalniki i zakłady spożywcze, itd. **Te płytki nie są przeznaczone do wykańczania powierzchni poziomych balkonów i tarasów. Asortyment POOL ma nasiąkliwość poniżej 1 %, jest mrozo odporne i nadaje się do basenów zewnętrznych.**

Płytki produkowane są w szerokiej kolorystyce, z błyszczącą i matową powierzchnią, zdobione różnymi technikami (druk, posypka, natrysk), ewentualnie ze szklivem lub reliefem przeciwpoślizgowym. Płytki z powierzchnią ze złota, platyny i masy perłowej można stosować jedynie do wykańczania ścian we wnętrzach!

Płytki ścienne, numer katalogowy: Wxxxxxxx
 to szklione okładzinowe elementy ceramiczne, o nasiąkliwości powyżej 10%, produkowane zgodnie z normą EN 14411:2016 BlII GL, załącznik normatywny L. Przeznaczone są do okładania ścian wewnętrznych, które nie są wystawione na działania atmosferyczne, mrozu, stałe obciążenie wodne, działanie kwasów i zasad, oraz ich oparów, lub na działanie środków ściernych. Z tego powodu są stosowane na ściany łazienek, kuchni, pralni i pozostałych pomieszczeniach wewnętrznych. **W pomieszczeniach, w których płytka ścienna o większej nasiąkliwości, będzie narażona na bezpośredni kontakt z wodą, jak prysznice, należy zastosować fugę typu CG2WA z obniżoną nasiąkliwością, np. fugi GF.** Powierzchnia płytek ściennych jest gładka lub z delikatnym reliefem, błyszcząca, półmatowa, lub matowa, z przezroczystym, półprzezroczystym lub nieprzezroczystym szklivem, jednobarwna lub kolorowa, zdobiona różnymi technikami (druk cyfrowy, rotocolor). W zależności od zastosowanego szkliwa (przezroczyste lub półprzezroczyste) nie można wykluczyć przejściowego przebarwienia płytki wynikającego z przenikania wilgoci z podłoża do ceramicznego czerepu. Do przebarwienia może dojść łatwiej przy wodo-przepuszczalnej spoinie, zastosowaniu warstwy izolacyjnej w podłożu (woda zostaje zamknięta między izolacją, a szklivem), lub wysokiej wilgotności powietrza w łazienkach o niedostatecznej wentylacji. Takie przejściowe przebarwienie nie oznacza jednak wady produktu. Wielkoformatowe płytki ścienna (30 x 60 i 30 x 90 cm) są produkowane również z rektyfikowaną krawędzią, która umożliwia ich precyzyjne układanie z minimalną spoiną.

Nieceramiczne materiały uzupełniające – szkło z numerem katalogowym Vxxxxxxx, kamień naturalny z numerem katalogowym Sxxxxxxx
 Są odpowiednim unikatowym uzupełnieniem płytek ceramicznych. Właściwości tych materiałów i charakterystyczne różnice koloru, struktury i innych właściwości są dane technologią produkcji lub ich naturalnym wyglądem.

Spiekane szklione płytki ciągnione i kształtki POOL, numer katalogowy: XPxxxxxx
 są to wysokospiekane szklione wyroby ceramiczne o bardzo niskiej nasiąkliwości, mniejszej lub równej 0,5 %, produkowane przez ciągnięcie według

System značení a doporučené použití keramických obkladových prvků RAKO | RAKO ceramic tiles and accessories – identification system and application recommendations | System oznaczania i zalecane użycie płytek ceramicznych RAKO | Система маркировки и рекомендуемое применение керамических облицовочных элементов RAKO

EN 14411:2016 Ala GL, załącznik M. Są przeznaczone do profesjonalnego wykańczania obrzeży basenów publicznych i prywatnych we wnętrzach i na zewnątrz.

Znakowanie produktu – szarża produkcyjna

Wszystkie ceramiczne elementy okładzinowe są produkowane w partiach, które mogą się wzajemnie różnić odcieniem i wymiarami. Poszczególne partie są oznaczone w dokumentacji towarzyszącej, na paletach i listach przewozowych. Na opakowaniach, oprócz numeru katalogowego, nazwy serii i rodzaju powierzchni, jest podany odcień, wymiar roboczy, gatunek oraz, ewentualnie odporność na ścieranie i przeciwpoślizgowość podłogowych płytek szklwionych.

Elementy okładzinowe z poszczególnych partii, z różnie oznaczonym odcieniem partii lub różnymi deklarowanymi wymiarami nie mogą być użyte na jednej powierzchni. Odcień jest podany na kartonach jako kombinacja dwóch lub trzech liter i cyfr, wymiary są oznaczone kodem numerycznym, patrz rys. 1, 2, tabela z deklarowanym wymiarem W, mm.

rys.1 **Karton z płytkami szklwionymi**



odcień kod wymiaru w mm jakość odporność na ścieranie

rys.2 **Karton z płytkami nieszklwionymi**



odcień kod wymiaru w mm jakość

Etykieta szklwionych płytek ściennych lub podłogowych

COBJ.WAAKB104.RA.1				
SYSTEM		Size / Rozměr: 25x33 cm		
matt / mat		Pallet: 54 boxes 81,000 M2		
Plant / Závod	Line, shade / Linka, odstín	Size/velikost	PAL	EAN
C223	4	LE	0	A E
odcień	cod wymiaru w mm	nominalny rozmiar		

Przed rozpoczęciem układania trzeba skontrolować dane na opakowaniach.

Łączenie elementów wykończonych, o różnych numerach katalogowych, na jednej powierzchni trzeba uprzednio uzgodnić i pisemnie zamówić u dostawcy lub sprzedawcy.

Certyfikaty i deklaracje właściwości

Kontrola stałości właściwości użytkowych ceramicznych elementów okładzinowych jest przeprowadzana zgodnie z Rozporządzeniem Parlamentu Europejskiego i Rady UW nr 305/2011 z dnia 9. 3. 2011, system oceny 4:

Deklaracja właściwości użytkowych T13 01 – płytki podłogowe spiekane nieszklwione BIa

Deklaracja właściwości użytkowych D13 01 – płytki podłogowe szklwione BIa

Deklaracja właściwości użytkowych G13 01 – gęste płytki podłogowe szklwione BIb

Deklaracja właściwości użytkowych W13 01 – płytki ceramiczne szklwione BIII

Deklaracja właściwości użytkowych P 01 – Mozaika ścienna i podłogowa

Deklaracja właściwości użytkowych P 02 – Kształtki ceramiczne, stopnice itd.

Deklaracja właściwości użytkowych P 03 – Produkty z naturalnego kamienia

Deklaracja właściwości użytkowych P 04 – Ceramiczne listwy reliefowe i dodatki

Deklaracje producenta są do ściągnięcia w różnych wersjach językowych na www.rako.eu

(<http://www.rako.cz/pl/do-sciagniecia/deklaracje.html> ew. <http://www.rako.cz/ke-stazeni/prohlaseni.html>

<http://www.rako.cz/en/download/declarations.html>, <http://www.rako.cz/de/download/erklarungen.html>).

System značení a doporučené použití keramických obkladových prvků RAKO | RAKO ceramic tiles and accessories – identification system and application recommendations | System oznaczania i zalecane użycie płytek ceramicznych RAKO | Система маркировки и рекомендуемое применение керамических облицовочных элементов RAKO

RU5 Rekomendované применение предлагаемых типов керамических облицовочных элементов:

Высокоспекаемая неглазуванная напольная плитка TAURUS, артикул: Txxxxxxx

- это керамические высокоспекаемые неглазуванные морозоустойчивые облицовочные элементы с очень низким водопоглощением (ниже или равным 0,5 %), соответствующие требованиям европейского стандарта EN 14411:2016 BIa UGL, приложение G. Данные изделия предназначены для устройства: полов, подвергающихся климатическим воздействиям: полов с высокой, вплоть до экстремальной, механической нагрузкой, истиранием и загрязнением. Плитка этого типа отлично подходит для устройства пола: в ресторанах, административных зданиях, автосалонах, пищевых и химических цехах, а также для отделки наружных горизонтальных поверхностей балконов, террас и пассажей. Плитка отличается высокой прочностью, морозостойкостью и устойчивостью к химическим воздействиям. Полированная напольная плитка и предназначены для оформления эксклюзивных интерьеров и фасадов.

Высокоспекаемая неглазуванная напольная плитка TAURUS выпускается: в одноцветном и многоцветном исполнении, с рельефной противоскользящей поверхностью, со стандартной гладкой поверхностью, или полированной поверхностью. Керамическая масса (черепок) прокрашивается, чем заменяется эстетическая функция глазури и формируется непосредственный дизайн поверхности. В соответствии с законодательством материалы с декларированными противоскользящими свойствами необходимо применять для устройства полов в помещениях, в которых имеется опасность поскользнуться. Ректификация напольной (30x60 и 60x60 см) и полированной напольной плитки осуществляется в соответствии со строго заданным размером, что позволяет выполнять безукоризненную укладку плитки и сочетать форматы. Облицовочные элементы из серии TAURUS INDUSTRIAL изготавливаются с увеличенной толщиной 15 мм и предназначены для устройства особо интенсивно эксплуатируемых полов на промышленных предприятиях (например, мастерские, производственные цеха и склады).

Высокоспекаемая глазуванная керамическая напольная плитка KENTAUR, артикул: Dxxxxxxx

- это керамические высокоспекаемые неглазуванные морозоустойчивые облицовочные элементы с очень низким водопоглощением (ниже или равным 0,5 %), соответствующие требованиям европейского стандарта EN 14411:2016 BIa UGL, приложение G. Изделия данного типа универсальны. Они могут применяться для внутренней и наружной облицовки стен и полов, могут подвергаться влиянию климатических условий, высокой механической нагрузке и загрязнению. Плитка этого типа отлично подходит для применения в квартирах и жилых домах, а также для отделки террас и балконов. Для объектов общественного назначения (например: рестораны, магазины, гостиницы, государственные учреждения, автосалоны) рекомендуем применять напольную плитку с классом износостойкости PEI5 и декларированными противоскользящими свойствами. Спекаемая глазуванная плитка серии KENTAUR изготавливается в широком цветовом ассортименте, с различным дизайном и разнообразным исполнением поверхности (гладкая, рельефная, противоскользящая, полуматовая и т.д.). Керамическая масса (черепок) у некоторых изделий прокрашивается, для того, чтобы сгладить цвет черепка с глазурью в случаях, когда на поверхности плитки путем фрезеровки создается рифление (для придания плитке противоскользящих свойств) или на плитке, предназначенной для облицовки лестничных ступеней, шлифуются круглые грани. Ректификация крупноформатной керамической плитки (30 x 60, 60 x 60, 40 x 80, 80 x 80, 20 x 120 а 30 x 120 см) осуществляется в соответствии со строго заданным размером, что позволяет выполнять безукоризненную укладку плитки и сочетать форматы.

Глазуванная напольная плитка с плотным черепком, артикул: Bxxxxxxx

- это керамические глазуванные облицовочные элементы с водопоглощением выше 0,5% и меньшим или равным 3,0%, соответствующие требованиям европейского стандарта EN 14411:2016 BIb GL, приложение H.

Плитку можно использовать для устройства полов и стен в помещениях, а также для отделки фасадов, подверженных влиянию климатических условий. Плитка данного типа универсальна, подходит для устройства полов и облицовки стен ванных комнат, кухонь, коридоров, офисов, наружных фасадов, бассейнов в интерьерах саун, душевых комнат бассейнов и общественных зданий, плитку также можно использовать в холодильных и пищевых цехах и т.д. **Плитка не предназначена для облицовки горизонтальных поверхностей балконов и террас. Плитка серии POOL имеет водопоглощение ниже 1%, является морозостойкой и пригодна для применения в открытых бассейнах.** Напольная плитка изготавливается в широком цветовом ассортименте, с глянцевои и матовой поверхностью, плитку украшается с применением различных техник (печать, посыпка, напыление), глазурью или рельефом в противоскользящем исполнении. Плитка с поверхностью, декорированной золотом, платиной и перламутром, пригодна только для внутренней отделки стен!

Настенная плитка, номер по каталогу: Wxxxxxxx

Глазуванные керамические облицовочные элементы с влагопоглощением свыше 10%, соответствующие требованиям европейского стандарта EN 14411:2016 BIII GL, приложение L. Настенная плитка предназначена для облицовки стен в интерьерах, не находящихся под воздействием погодных условий, мороза, постоянного воздействия воды, кислот, щелочей и их испарений, а также не подвергающимся воздействию абразивных моющих средств. Настенная плитка применяется для облицовки стен в ванных комнатах, на кухне, в прачечных и в остальных интерьерах. **В помещениях, где пористая плитка подвержена прямому воздействию воды, в душе, и т.д., надо использовать тип затирки CG2WA с пониженным водопоглощением, например: затирка GF.** Поверхность настенной плитки гладкая или имеет тонкий рельеф, с глянцевой, полуматовой или матовой глазурью, глазурь может быть прозрачной, полупрозрачной или непрозрачной, в одноцветном или многоцветном исполнении, с украшениями, выполненными с использованием различных техник (цифровая печать, ротационная печать). В зависимости от примененного типа глазури (прозрачная, полупрозрачная) нельзя исключить возникновение временной темной окраски настенной плитки, обусловленной конструкцией плитки и связанной с проникновением влаги в черепок настенной плитки. Кроме того, окраска может быть усилена водонепроницаемостью швов, изоляционными слоями в основании (вода остается замкнутой между изоляционным слоем и глазурью) и высокой влажностью воздуха в ванных комнатах с недостаточной вентиляцией. Необходимо отметить, что данное временное потемнение не представляет собой дефект изделия. Крупноформатная настенная плитка (30 x 60 и 30 x 90 см) производится также в ректифицированном исполнении, позволяющем осуществлять точную укладку с узким швом.

Дополнительные некерамические материалы – стеклянные изделия с артикулом Wxxxxxxx, натуральный камень с артикулом Sxxxxxxx

- уникальные дополнения к керамической плитке. Свойства данных материалов и характерная разница в цвете и структуре определены технологией производства или природным происхождением.

Высокоспекаемая глазуванная экструдированная напольная плитка и фасонные элементы POOL, артикул: XPxxxxxxx

- это высокоспекаемые глазуванные морозостойкие керамические элементы с водопоглощением ниже или равным 0,5%, изготавливаемые методом экструзии и соответствующие требованиям европейского стандарта EN 14411:2016 Ala GL, приложение M, которые предназначены для профессионального устройства элементов общественных и частных, внутренних и открытых бассейнов.

Маркировка изделий – производственная партия

Все керамические облицовочные элементы выпускаются партиями. Отдельные партии могут отличаться по оттенку цвета и по размеру. Каждая партия обозначена в сопроводительной документации, на поддонах и в накладных. На упаковке, кроме номера по каталогу, названия серии и вида поверхности, указывается оттенок, декларируемый размер, качество, а также износостойкость и противоскользящие свойства плитки.

Облицовочные элементы партий с различной маркировкой по тону или калибру запрещено применять на одной поверхности. Тон на коробках обозначен сочетанием двух или трех букв и цифр, калибр указан цифровым кодом, см. рис. 1, 2, таблица с декларированным размером W, мм.

Systém značení a doporučené použití keramických obkladových prvků RAKO | RAKO ceramic tiles and accessories – identification system and application recommendations | System oznaczenia i zalecane użycie płytek ceramicznych RAKO | Система маркировки и рекомендуемое применение керамических облицовочных элементов RAKO

рис.1 Коробка для глазурованных элементов



оттенок цвета код размера в мм сорт износостойкость

Коробка для неглазурованных элементов

рис.2



оттенок цвета код размера в мм сорт

Метка для глазурованной настенной и напольной плитки

COBJ.WAAKB104.RA.1					
SYSTEM		Size / Rozměr: 25x33 cm			
matt / mat		Pallet: 54 boxes 81,000 M2			
Plant / Závod	Line, shade / Linka, odstín	Size/velikost	PAL	EAN	
C223	4	LE	0	A	E

оттенок цвета код размера в мм номинальный размер

Метка для неглазурованной напольной плитки

CGRA.TAA35065.LB.1					
TAURUS GRANIT		Size / Rozměr: 30x30 cm			
standard / standardní		Pallet: 52 boxes 52,000 M2			
Plant / Závod	Line, shade / Linka, odstín	Size/velikost	PAL	EAN	
C231	8	L8	9	A	E

оттенок цвета код размера в мм номинальный размер

Перед началом работ необходимо проверить данные на упаковке.

Сочетание облицовочных материалов различных артикулов на одной поверхности необходимо заранее оговорить, заказ оформляется в письменной форме у поставщика или продавца.

Сертификация и декларация свойств

Проверка постоянства свойств типов керамических облицовочных элементов проведена согласно Директиве Европейского парламента и Совета ЕС № 305/2011 от 9. 3. 2011, система оценки 4:

Декларация свойств T13 01 – высокоспекаемая неглазурованная напольная плитка BIa

Декларация свойств D13 01 – высокоспекаемая глазурованная напольная плитка BIa

Декларация свойств G13 01 – глазурованная напольная плитка с плотным черепком BIb

Декларация свойств W13 01 – глазурованная настенная плитка BIII

Декларация свойств P 01 – Мозаика для облицовки стен и полов. (Постановление правительства № 163/2002 Сб. законов, в редакции постановления правительства № 312/2005 Сб. законов)

Декларация свойств P 02 – Керамическая фасонная плитка, плитка для облицовки лестничных ступеней и т.д. (Постановление правительства № 163/2002 Сб. законов, в редакции постановления правительства № 312/2005 Сб. законов)

Декларация свойств P 03 – Изделия из естественного камня.

Декларация свойств P 04 – Керамические рельефные плитки – бордюры и керамические аксессуары (Постановление правительства № 163/2002 Сб. законов, в редакции постановления правительства № 312/2005 Сб. законов)

Сертификаты производителя доступны на различных языках на сайте www.rako.eu

(<http://www.rako.cz/ke-stazeni/prohlaseni.html> или <http://www.rako.cz/en/download/declarations.html>,

<http://www.rako.cz/de/download/erklarungen.html>).

Rozměry a geometrické parametry | Sizes and geometric parameters | Rozmiary i parametry geometryczne | Размеры и геометрические размеры

CZ Jmenovité a deklarované rozměry:

Keramické obkladové prvky se označují podle EN 14411:2016 **jmenovitými rozměry** v cm, např. 10 x 10, 20 x 20 cm. Konkrétní vyrobený rozměr – deklarovaný rozměr (W) keramického prvku – je uveden na obalu v mm. Metodiku stanovení geometrických parametrů keramických obkladových prvků a povolených odchylek od deklarovaných rozměrů popisuje norma EN ISO 10545-2. Požadované hodnoty a tolerance pro všechny typy výrobků společnosti LASSELSBERGER, s.r.o., jsou uvedeny v informačních přílohách katalogů RAKO HOME a RAKO OBJECT.

Rektifikované obkladové prvky

Dlaždice s nízkou nasákovostí o rozměrech 10 x 10, 20 x 20, 22,5 x 45, 22,5 x 22,5, 15 x 45, 45 x 45, 15 x 60, 30 x 60, 60 x 60, 40 x 80, 80 x 80, 20 x 120 a 30 x 120 cm a obkládačky 30 x 60 a 30 x 90 cm jsou převážně nabízeny s rektifikovanými hranami, které jsou zabroušeny s vysokou přesností a umožňují pokládku s úzkou spárou až od 2 mm. V katalogu jsou **rektifikované (zabroušované) obkladové prvky vždy označeny ikonou s písmenem R**. Zabroušené hrany rektifikovaných obkladů a dlažeb jsou křehké a vyžadují pečlivou a opatrnou manipulaci. Neopatrný pohyb a kontakt s jiným materiálem mohou způsobit odštípnutí hrany nebo rohu obkladu.

Nerektifikované obkladové prvky

Nerektifikované obkladové prvky v sérii ColorTWO, POOL a TAURUS z katalogu RAKO OBJECT jsou převážně vyráběny v modulových rozměrech 8. Kromě toho jsou vyráběny nerekifikované obkládačky v modulových rozměrech 8 z katalogu RAKO HOME ve formátu 20 x 40, 20 x 60 a 30 x 60 cm a nerekifikované dlaždice formátu 10 x 10, 20 x 20, 10 x 20, 30 x 30, 33 x 33 a 45 x 45 cm. **U nerekifikovaných obkladových prvků včetně doplňků hraje rozhodující roli deklarovaný rozměr výrobku obsažený v šarži produktu, který je důležitý při skladbě více druhů keramických obkladových prvků do jedné plochy a pro zachování stejné šířky spáry. Díky přirozeným rozměrovým nepřesnostem u nerekifikovaných výrobků však nedoporučujeme pokládku se spárou užší než 2 mm. Rozměrové rozdíly v souladu s normou jsou u velmi úzké spáry viditelné. Proto u pokládky nerekifikovaných obkladových prvků doporučujeme šířku spáry cca 3–4 mm.**

Modulové rozměry

Modulové rozměry, např. M 10 x 10, M 20 x 20 cm, jsou vhodné pro kombinování obkladových prvků různých formátů do jedné plochy při zachování průběžných spár. Např. u rozměru 8 (598 x 598, 298 x 598 mm) umožňuje modulově kombinovat uvedené formáty leštěných, lapovaných a standardních dlaždic, popř. rektifikovaných obkládaček, na jednu plochu při stejné spáře. **Spáry užší než 2 mm ale snižují schopnost vstřebávat pnutí mezi podkladem a samotnou dlažbou. Např. rakouská norma ÖNORM B 3407:2015 stanovuje pro interiér minimální šířku nepružné spáry 2 mm a pro exteriér 5 mm. Zásadně nedoporučujeme pokládku beze spár, tzv. nasraz. Tento způsob zcela eliminuje vstřebávání pnutí mezi podkladem a dlažbou, navíc zanesená nečistota ve spárách je neodstranitelná.** Keramické výrobky s modulovými rozměry jsou tvořeny násobky základního rozměru. Do rozměru výrobku je započítávána i šířka jednotné spáry, takže lze vytvořit i v ploše z různých formátů pravidelné spárování.

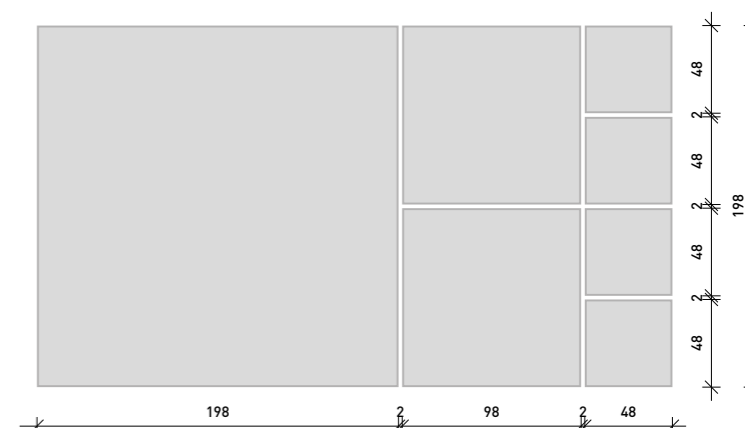

Mosaiky, dekory

Jsou nabízeny např. ve jmenovitých rozměrech 2,5 x 2,5, 5 x 5, 5 x 10 cm apod. Rozměry jednotlivých druhů mozaiky, dekorů a doplňků jsou odvozené od rozměrů základních formátů, ke kterým jsou rozměrově doladěné. Jednotlivé prvky jsou nalepeny na umělohmotné nebo papírové sítky – sety – o rozměrech 30 x 30, 30 x 60 cm apod., které urychlují a usnadňují pokládku do lepicí hmoty třídy C2. V případě potřeby je možné rozříznutím sítky sety upravit na pásy, listy, nebo velikost setů a spár korigovat podle okolních prvků a velkoplošných dlaždic. Povolené odchylky od deklarovaných rozměrů popisují Stavebně technická osvědčení – STO, viz webová stránka www.rako.cz/ke-stazeni/certifikaty.

EN Nominal and declared size:

Ceramic tiles are identified according to EN 14411:2016 with **nominal sizes** in cm, for example: 10 x 10, 20 x 20 cm. Specific manufactured sizes – **declared dimensions (W)** of ceramic tiles are shown on packaging in mm. Methods to determine geometric parameters of ceramic tiles and allowed deviations from the declared sizes are described in the standard EN ISO 10545-2. The declared size is specified on packaging and delivery notes in millimetres. Accurate values and tolerance for all types of LASSELSBERGER, s.r.o. products are provided in information annexes to the catalogues RAKO HOME and RAKO OBJECT.

Rectified Tiles

Low-absorption floor tiles of sizes 10 x 10, 20 x 20, 22,5 x 45, 22,5 x 22,5, 15 x 45, 45 x 45, 15 x 60, 30 x 60, 60 x 60, 40 x 80, 80 x 80, 20 x 120 and 30 x 120 cm and wall tiles of sizes 30 x 60 and 30 x 90 cm are mainly offered with rectified edges, which are ground with high precision and allow installation with a narrow joint from 2 mm. In the catalogue, **rectified (ground) tiles are always marked with the letter R icon**. The ground edges of the rectified wall tiles and floor tiles are fragile and require careful and cautious handling. Careless movement and contact with any other material could cause the tile edge or corner to be chipped off.

Non-rectified Tiles

Non-rectified tiles of the ColorTWO, POOL and TAURUS series included in the RAKO OBJECT catalogue are mostly made in module dimensions 8. In addition there are non-rectified wall tiles with module dimension 8 in the RAKO HOME catalogue in the sizes of 20 x 40, 20 x 60 and 30 x 60 and non-rectified floor tiles in the sizes of 10 x 10, 20 x 20, 10 x 20, 30 x 30, 33 x 33 and 45 x 45 cm. **For non-rectified tile elements including accessories, the decisive role is played by the declared dimensions of the product contained in the product batch, which are important when using several types of ceramic tile elements on one surface and for maintaining the same joint width. Owing to natural dimensional inaccuracies of the non-rectified products, we however do not recommend installing tiles with a joint narrower than 2 mm. Dimensional differences in the case of very narrow joints are discernible in accordance with the standard. For this reason, in the case of installation of non-rectified tile elements we recommend a joint width of about 3–4 mm.**

Module sizes

Module sizes, e.g. M 10 x 10, M 20 x 20 cm, are suitable for combinations of tiles of different formats on one surface while keeping running joints. For example size 8 (598 x 598, 298 x 598 mm) allows modular combinations of these sizes of polished, lapped and standard tiles or rectified tiles into a single surface with continuous joints. **However, joint widths narrower than 2 mm reduce the capability to absorb the tension between the base and the tile itself. For example, the Austrian ÖNORM B 3407:2015 standard stipulates the minimum width of a non-elastic joint of 2 mm for interiors and 5 mm for exteriors. As a rule, we do not recommend installation without joint spacing. This mode of installation completely eliminates the absorption of the tension between the base and the tile; moreover, the dirt that collects in the joints cannot be removed.** Ceramic products with module sizes consist of multiples of the basic sizes. The identification of the product size also includes the width of a uniform joint in order to achieve uniform joints on a surface made of different tile sizes.

Rozměry a geometrické parametry | Sizes and geometric parameters | Rozmiary i parametry geometryczne | Размеры и геометрические размеры

Mosaics, décors

These are offered for example in nominal sizes 2,5 x 2,5, 5 x 5, 5 x 10 cm etc. **The sizes of the individual types of mosaic, décors and accessories are derived from the basic tile sizes to which their dimensions are harmonised.** Individual elements are glued on plastic or paper mesh – sets in the sizes of 30 x 30, 30 x 60 cm etc., accelerating and facilitating laying in glue class C2. If necessary, the mesh of the set may be cut into individual bands or listellos. The size of the sets and joints may be corrected to suit adjacent elements and large tiles. Permitted deviations from the declared sizes are described in the Technical Construction Regulations – STO – see the website <http://www.rako.cz/en/download/certificates.html>.

PL Wymiary nominalne i robocze:

Zgodnie z normą EN 14411:2016 dla płytek ceramicznych podawane są **wymiary nominalne** w cm, na przykład 10 x 10, 20 x 20 cm. Konkretny wymiar wyrobu – **wymiar roboczy (W)** elementu ceramicznego jest podany na opakowaniu w mm. Metody określania parametrów geometrycznych płytek ceramicznych i dopuszczalne odchylenia od wymiarów roboczych opisuje norma EN ISO 10545-2. Wymagane wartości i tolerancje dla wszystkich typów produktów LASSELSBERGER, s.r.o., są podane w informacyjnych aneksach katalogów RAKO HOME i RAKO OBJECT.

Rektyfikowane płytki

Płytki gresowe w rozmiarach 10 x 10, 20 x 20, 22,5 x 45, 22,5 x 22,5, 15 x 45, 45 x 45, 15 x 60, 30 x 60, 60 x 60, 40 x 80, 80 x 80, 20 x 120 a 30 x 120 cm oraz płytki ścienne 30 x 60 a 30 x 90 cm są zwykle oferowane z rektyfikowanymi krawędziami, które są precyzyjnie szlifowane, co umożliwiają ich układanie z wąską fugą, do 2 mm. W katalogu, **plytki rektyfikowane – (szlifowane) są zawsze oznaczone ikoną z literą R**. Szlifowane krawędzie rektyfikowanych płytek są kruche i wymagają starannego i ostrożnego obchodzenia. Nieostrożny ruch i kontakt z innym materiałem może spowodować ukruszenie krawędzi lub rogu płytki.

Nierektyfikowane płytki

Nierektyfikowane płytki serii ColorTWO, POOL i TAURUS z katalogu RAKO OBJECT są produkowane przeważnie w modułowym kalibrze 8. Produkowane są także nierektyfikowane płytki ścienne w modułowym kalibrze 8. z katalogu RAKO HOME, w formatach 20 x 40, 20 x 60 i 30 x 60 cm oraz nierektyfikowane płytki podłogowe w formatach 10 x 10, 20 x 20, 10 x 20, 30 x 30, 33 x 33 i 45 x 45 cm. **W przypadku nierektyfikowanych płytek i dodatków ceramicznych ważną rolę odgrywa wymiar roboczy, oznaczony w szarży produktu, który jest istotny przy łączeniu różnych produktów na jednej powierzchni, przy zachowaniu jednakowej szerokości fugi. Z uwagi na naturalną niedokładność wymiarową nierektyfikowanych płytek ceramicznych, nie zalecamy układania ich z fugą węższą, niż 2 mm. Wymiary różnice, dopuszczalne obowiązującą normą, są bardzo widoczne przy stosowaniu wąskich fug. Stąd, przy układaniu płytek nierektyfikowanych zalecamy fugi szerokości ok. 3-4 mm.**

Wymiary modułowe

Wymiary modułowe, np. M 10 x 10, M 20 x 20 cm, nadają się do łączenia płytek o różnych formatach, na jednej powierzchni, przy zachowaniu nawijających spoin. Na przykład dla kalibru 8 (598 x 598, 298 x 598 mm) można łączyć modułowo te formaty płytek połączonych, lappato i standardowych, ewentualnie rektyfikowanych płytek ściennych na jednej powierzchni z zastosowaniem tej samej szerokości spoiny. **Fugi węższe niż 2 mm obniżają zdolność do kompensowania naprężeń pomiędzy podłożem a płytką. Przykładowo, austriacka norma ÖNORM B 3407:2015 określa minimalną szerokość fugi we wnętrzach 2 mm, zaś na zewnątrz, 5 mm. Zasadniczo nie zalecamy układania na styk, bez fug. Ten sposób całkowicie eliminuje możliwość kompensowania naprężeń pomiędzy podłożem a płytką, a nadto zabrudzenia, które dostaną się pomiędzy płytki są nieusuwalne.** Płytki ceramiczne w modułowych wymiarach powstają jako wielokrotność rozmiaru bazowego. Do rozmiaru płytki doliczana jest szerokość pojedynczej spoiny, dzięki czemu na powierzchni złożonej z płytek różnych formatów, uzyskuje się efekt regularnych spoin.

Mozaiki, dekory

Są dostępne przykładowo w nominalnych wymiarach 2,5 x 2,5, 5 x 5, 5 x 10 cm, itp. **Wymiary różnych rodzajów mozaiki, dekoracji i dodatków wynikają z wymiarów płytek bazowych, dla których są przeznaczone.** Poszczególne elementy są klejone na siatki z tworzywa sztucznego lub z papieru – arkusze w rozmiarach 30 x 30, 30 x 60 cm, itp., które ułatwiają i przyspieszają ich montaż z zastosowaniem kleju typu C2. W razie potrzeby, przez rozcięcie siatki, można arkusze przerobić na paski lub dostosować ich rozmiar lub szerokość spoin do otaczających kształtek, czy dużych płytek. Parametry mozaiki ujęte są w deklaracji właściwości użytkowych, patrz: <http://www.rako.cz/en/download/certificates.html>.

RUS Номинальные и декларируемые размеры:

Dla ceramicznych облицовочных элементов, согласно требованиям стандарта EN 14411:2016 указываются **номинальные размеры** в см, например, 10 x 10, 20 x 20 см. Конкретный размер изделия – **декларируемый размер (W)** керамического элемента указан на упаковке в мм. Методика определения геометрических параметров керамических облицовочных элементов и допустимых отклонений от геометрических размеров описана в стандарте EN ISO 10545-2. Декларируемый размер указывается на упаковке и накладных в мм. Требуемые размеры и допуски для всех видов изделий, производимых компанией «LASSELSBERGER, s.r.o.» приведены в информационных приложениях каталогов RAKO HOME и RAKO OBJECT.

Ректифицированные облицовочные элементы

Напольная плитка с низкой водопоглощаемостью размером 10 x 10, 20 x 20, 22,5 x 45, 22,5 x 22,5, 15 x 45, 45 x 45, 15 x 60, 30 x 60, 60 x 60, 40 x 80, 80 x 80, 20 x 120 и 30 x 120 см и настенная плитка размером 30 x 60 и 30 x 90 см преимущественно предлагается с калиброванными гранями, которые отшлифованы с высокой точностью и позволяют укладку с узким швом от 2 мм. В каталоге **ректифицированные (отшлифованные) облицовочные элементы всегда обозначаются символом с буквой R**. Шлифованные грани калиброванной напольной и настенной плитки являются хрупкими, поэтому необходимо обращаться с ними особо осторожно и внимательно. Неосторожное движение и соприкосновение с другим материалом могут привести к откалыванию грани или угла плитки.

Некалиброванные облицовочные элементы

Некалиброванные облицовочные элементы серий ColorTWO, POOL и TAURUS из каталога RAKO OBJECT преимущественно изготавливаются в модельных размерах 8. Кроме этого также производится неректифицированная настенная плитка модульных размеров 8 из каталога RAKO HOME в форматах 20 x 40, 20 x 60 и 30 x 60 и неректифицированная напольная плитка размером 10 x 10, 20 x 20, 10 x 20, 30 x 30, 33 x 33 и 45 x 45 см. **У некалиброванных облицовочных элементов, включая аксессуары, решающую роль имеет декларируемый размер изделия, указанный в маркировке партии продукции, данный размер важен при сборке нескольких видов керамических облицовочных элементов в одну поверхность и для сохранения одинаковой ширины зазора. Благодаря естественным колебаниям размеров некалиброванных изделий не рекомендуется выполнять укладку плитки со швом менее 2 мм. Отклонения в размерах, находящиеся в пределах нормы, при укладке плитки с узким швом являются заметными. Поэтому при укладке некалиброванных облицовочных элементов рекомендуем соблюдать ширину шва 3-4 мм.**

Модульные размеры

Модульные размеры, например, M 10 x 10, M 20 x 20 cm, пригодны для сочетания облицовочных элементов различных форматов на одной поверхности, при сохранении текущих швов. Например, у размера 8 (598 x 598, 298 x 598 мм) модульность размеров позволяет сочетать указанные форматы гляцевой, шлифованной и стандартной напольной плитки, при необходимости и ректифицированной настенной плитки на одной поверхности при сохранении одинаковой ширины шва. **Швы шириной менее 2 мм снижают способность поглощать напряжения между основанием и самой напольной плиткой. Например, австрийский стандарт ÖNORM B 3407:2015 для интерьеров определяет минимальную ширину неупругого шва 2 мм, а для экстерьера – 5 мм. Настойчиво не рекомендуем укладку без швов, т.е. впритык. Данный способ укладки не позволяет поглощение напряжений между основанием и напольной плиткой, кроме того, загрязнения, попадающие в шов, невозможно устранить.** Керамические изделия с модульными размерами кратны базовому размеру. В размер изделия включается и ширина стандартного шва, т.е. и на поверхности, составленной из плитки различного размера, можно создать регулярный рисунок швов.

Rozměry a geometrické parametry | Sizes and geometric parameters | Rozmiary i parametry geometryczne | Размеры и геометрические размеры

Мозаики, декоративные элементы

Предлагаются в номинальных размерах 2,5 x 2,5, 5 x 5, 5 x 10 см и т.д. **Размеры отдельных видов мозаики, декоративных элементов и дополнений являются производными от базовых форматов и подстроены под данные размеры.** Отдельные элементы наклеены на пластмассовые или бумажные сетки (наборы) размером 30 x 30 см, 30 x 60 см и т.д., которые ускоряют и упрощают укладку на клеящую массу класса C2. В случае необходимости возможно, наборы разрезать на ленты, листеллы, или корректировать размер наборов и швов в зависимости от соседних элементов и крупноформатной напольной плитки. Допустимые отклонения от декларируемых размеров указаны в Строительных технических регламентах, см. сайт www.rako.eu, раздел «Скачать» - «Сертификаты».



Nasákavost | Water absorption | Nasiąkliwość | Водопоглощение

CZ Nasákavost je nejdůležitější vlastností při výběru keramických dlaždic pro určité prostředí. Nasákavost je schopnost keramických výrobků absorbovat vodu nebo jiné kapaliny. Je vyjádřena poměrem hmotnosti absorbované vody a vysušeného keramického vzorku v procentech za podmínek, které stanoví zkušební norma EN ISO 10545-3. Stltnuté keramické dlaždice s nízkou nasákavostí vykazují nejlepší vlastnosti v extrémních podmínkách, zejména odolnost proti mrazu.

EN Water absorption is the most important property in selection of a tiling material for a specific environment. Water absorption is ability of a fired ceramic product to absorb liquid, and is a percentage expression of the ratio of water absorbed by a test specimen and the weight of the dry specimen under the conditions of test standard EN ISO 10545-3. Ceramic tiles with low water absorption show best operating characteristics and resistance to the most severe operating conditions, especially frost resistance.

PL Nasiąkliwość jest najistotniejszą właściwością w procesie doboru odpowiednich płytek do konkretnych warunków. Nasiąkliwość jest zdolnością wchłaniania cieczy przez wypalony czerep ceramiczny i wyraża procentową zależność cieczy wchłoniętej przez testowaną próbkę do wagi suchej próbki, zgodnie z wymaganiami normy EN ISO 10545-3. Ceramika o niskiej nasiąkliwości wykazuje najlepsze parametry robocze i odporność na najcięższe warunki, a w szczególności na działanie mrozu.

RUS Является наиболее важной характеристикой для определения типа плитки, необходимого для данной области применения. Водопоглощение – это свойство керамических изделий поглощать воду или другие жидкости. Выражается отношением веса абсорбированной воды и высушенного керамического образца в процентах, при проведении испытаний в условиях, определенных нормой EN ISO 10545-3. Керамическая плитка с низкими показателями водопоглощения обладает наилучшими свойствами в экстремальных условиях, особенно морозоустойчивостью.



Odolnost proti vlivu mrazu | Frost resistance | Mrozoodporność | Морозоустойчивость

CZ Pro venkovní obklady a dlažby je zapotřebí používat mrazuvzdorné keramické dlaždice, které jsou odolné vůči dlouhodobému působení mrazu a povětrnostním vlivům. Odolnost proti mrazu se testuje pomocí předem stanoveného počtu cyklů zmrazování a rozmrazování, a to při podmínkách stanovených podle normy EN ISO 10545-12. Nízká nasákavost je nejlepším předpokladem dokonalé mrazuvzdornosti. Pórovinné obkládačky nejsou mrazuvzdorné a jsou určeny výhradně pro vnitřní prostory. Pro podlahy a stěny v exteriérech doporučujeme vysoce odolné neglazované nebo glazované stltnuté dlaždice skupiny B1a podle EN 14411:2016.

EN For exteriors it is necessary to use only frost resistant ceramic tiles, which resist long action of frost and weather. Frost resistance is tested by stated number of frosting and defrosting cycles under specified conditions according to standard EN ISO 10545-12. There is a relation between frost resistance and water absorption. The lower is water absorption the higher is frost resistance. Ceramic wall tiles EN 14411:2016 B111 are not frost resistant and therefore are suitable for interiors only. For exterior floors and walls in we recommend using highly resistant unglazed or glazed vitrified tiles, group B1a according to EN 14411:2016.

PL Do zastosowań na zewnątrz, konieczną cechą płytek jest mrozoodporność, dzięki której opierają się one długotrwałemu działaniu niskich temperatur i trudnych warunków pogodowych. Badanie mrozoodporności odbywa się w oparciu o poddanie płytek określonej liczbie cykli zamrożenia i rozmrożenia, zgodnie z normą EN ISO 10545-12. Występuje zasadnicza zależność pomiędzy mrozoodpornością i nasiąkliwością płytek – im niższa jest nasiąkliwość tym lepsza mrozoodporność. Porowata glazura nie jest mrozoodporna i jest przeznaczona tylko i wyłącznie do pomieszczeń wewnętrznych. Na posadzki i ściany na zewnątrz proponujemy, mocno odporne nieszkliwione lub szkliwione gresy z grupy B1a, według normy EN 14411:2016.

RUS Для наружной облицовки необходимо использовать морозоустойчивую плитку, обладающую устойчивостью к долговременному атмосферному влиянию и низким температурам. Морозоустойчивость испытывается проведением установленного количества циклов промерзания и оттаивания, в условиях, определенных требованиями Чешской государственной нормы EN ISO 10545-12. Низкое влагопоглощение является наилучшей предпосылкой совершенной морозоустойчивости. Настенная керамическая плитка EN 14411 B 111 не является морозоустойчивой и применяется исключительно для облицовки внутренних помещений. Для облицовки полов и стен в экстерьерах рекомендуется применять плитку с высокой степенью износостойкости, глазурованную или неглазурованную спекаемую напольную плитку группы B1a согласно стандарту EN 14411:2016.

PEI Odolnost proti povrchovému opotřebení – otěruvzdornost | Abrasion resistance Odporność na ścieranie powierzchniowe | Устойчивость к абразивному износу

CZ Odolnost proti povrchovému opotřebení – otěruvzdornost – je schopnost glazovaných keramických výrobků odolávat za daných podmínek účinku brusné směsi. Glazované dlaždice se dělí na různé třídy odolnosti. Třídy odolnosti glazovaných dlaždic se stanoví podle EN ISO 10545-7 při mokrému testu „PEI“. Pomocí částic z oxidu hlinitého, s ocelovými kuličkami a s vodou se v excentricky obíhající soustavě simuluje umělý otěr. Testované dlaždice se poté rozdělí podle počtu otáček při nepoškozeném povrchu do skupin PEI 1 až PEI 5.

• **Třída odolnosti PEI 1**

Glazované keramické dlaždice, po kterých se chodí s botami s měkkou podrážkou při nízké frekvenci chození, bez přítomnosti abrazivního znečištění. Použití v koupelnách, v ložnicích, v bytech kromě předsíní, teras, kde hrozí nebezpečí nanesení venkovních nečistot.

• **Třída odolnosti PEI 2**

Glazované keramické dlaždice, které jsou zatěžovány normální obuví při nízké frekvenci chození s nepatrným abrazivním znečištěním. Použití v koupelnách a bytech kromě vstupních a jim podobných prostor, které jsou frekventovanější a hrozí tam nebezpečí nanesení venkovních nečistot.

• **Třída odolnosti PEI 3**

Glazované keramické dlaždice, které jsou zatěžovány normální obuví při střední frekvenci chození, s nepatrným abrazivním znečištěním. Použití v celém bytě, v rodinných domech, v hotelových koupelnách.

• **Třída odolnosti PEI 4**

Glazované keramické dlaždice, které jsou intenzivněji namáhány při silnější frekvenci chození v normální obuvi při zvýšeném znečištění a zatížení. Použití pro výstavní a obchodní prostory, kanceláře.

• **Třída odolnosti PEI 5**

Glazované keramické dlaždice, které jsou při vysoké frekvenci chození vystaveny vysokému znečištění a namáhání opotřebením. Použití v obchodech, restauracích, u pultů a přepážek, v garážích, na nádražích a v letištních halách.

EN It is important that tiles used on the floor have a suitable surface resistance (abrasion) and glazed floor tiles are divided into different classes depending on the density and contamination of foot traffic. The abrasion resistance of glazed floor tiles is determined according to EN ISO 10545-7 with aluminium-oxide-grains, balls of steel and water in an eccentric circling system in the PEI-wet-test. Tiles tested according to EN are divided into Groups from PEI 1 to PEI 5 according to the undamaged area remaining after testing.

• **Class PEI 1**

Glazed ceramic floor tiles for low interior foot traffic without the likelihood of scratching. Application in bathrooms, bedrooms, apartments except in entrance halls, terraces without the danger of dirt being brought in from outdoors.

• **Class PEI 2**

Glazed ceramic floor tiles for medium interior foot traffic. Application in bathrooms and apartments except in entrance halls and similar rooms with heavier traffic and a danger of dirt being brought in from outdoors.

• **Class PEI 3**

Glazed ceramic floor tiles for medium but heavier foot traffic with slight risk of abrasion, such as living rooms, hotel bathrooms.

• **Class PEI 4**

Glazed ceramic floor tiles for medium to high foot traffic with risk of abrasion and normal work shoes in entrance halls, commercial rooms and offices.

• **Class PEI 5**

Glazed ceramic floor tiles for use in high foot traffic areas such as doorways, stores, corridors, garages, railway stations and airport halls.

PL Odporność na ścieranie powierzchni – jest to odporność szkliwionych wyrobów ceramicznych na działanie mieszaniny ścierniej w zadanych warunkach. Podłogowe płytki szkliwione dzielone są na różne klasy odporności. Odporność na ścieranie płytek szkliwionych jest określana zgodnie z EN ISO 10545-7, przy pomocy mokrej próby „PEI”. Przy pomocy cząstek tlenku glinu, stalowych kuleczek i wody, w układzie obrotowym mimośrodowo symuluje się proces ścierania. Badane płytki są następnie rozdzielane, na podstawie liczby obrotów przy nieuszkodzonej powierzchni, do grup od PEI 1 do PEI 5.

• **Klasa PEI 1**

Szkliwione płytki podłogowe przeznaczone na posadzki o niskim natężeniu ruchu pieszego, wystawione tylko na kontakt z miękkim obuwiem, bez ryzyka zarysowania. Są przeznaczone do stosowania w łazienkach, sypialniach, mieszkaniach, oprócz przedsionków, tarasów, gdzie grozi niebezpieczeństwo nanieśienia zanieczyszczeń z zewnątrz.

• **Klasa PEI 2**

Szkliwione płytki podłogowe przeznaczone na posadzki o średnim natężeniu ruchu pieszego. Przeznaczone do stosowania w łazienkach i mieszkaniach, oprócz pomieszczeń wejściowych i podobnych, które są intensywnie używane i grozi w nich niebezpieczeństwo naniesienia zanieczyszczeń z zewnątrz.

• **Klasa PEI 3**

Szkliwione płytki podłogowe przeznaczone na posadzki o średnim wyższym natężeniu ruchu pieszego, w niewielkim stopniu narażone na ścieranie, np salony, łazienki hotelowe.

• **Klasa PEI 4**

Szkliwione płytki podłogowe przeznaczone na posadzki o średnim lub wysokim natężeniu ruchu pieszego, narażone na ścieranie i kontakt z normalnym i roboczym obuwiem, np w holach wejściowych, przestrzenie handlowe i biurowe.

• **Klasa PEI 5**

Szkliwione płytki podłogowe przeznaczone na posadzki o wysokim natężeniu ruchu pieszego, np. hole wejściowe, korytarze, magazyny, garaże, dworce i lotniska.

RUS Устойчивость к абразивному износу (износоустойчивость) представляет собой способность глазурованной плитки не подвергаться влиянию абразивной смеси. Глазурованная плитка делится на несколько классов устойчивости. Классы устойчивости, согласно EN ISO 10545-7 определяются при мокром испытании «PEI». С помощью литого кремнезема, стальных шариков и воды в условиях цилиндрического трения между диском и поверхностью вызывается искусственное истирание. Тестируемая плитка, в зависимости от количества оборотов при неповрежденной поверхности делится на классы от I до V.

• **Класс устойчивости PEI 1**

Глазурованные керамические напольные покрытия, по которым ходят в обуви с мягкой подошвой при низкой интенсивности хождения, без присутствия абразивного загрязнения. Облицовочные элементы предназначены для применения в ваннных комнатах, спальнях, в квартирах, кроме прихожих, террас и прочих помещений, на которых имеется угроза попадания загрязнений с улицы.

• **Класс устойчивости PEI 2**

Глазурованные керамические напольные покрытия, по которым ходят в обычной обуви при низкой интенсивности хождения, с небольшим абразивным загрязнением. Применение в ваннных комнатах и квартирах, кроме входных помещений и подобных интенсивно эксплуатируемых помещений, в которых имеется опасность попадания загрязнений с улицы.

• **Класс устойчивости PEI 3**

Глазурованные керамические напольные покрытия, которые интенсивно используются со значительной частотой хождения в обычной обуви и абразивным загрязнением. Используются во всей квартире, в ваннных комнатах гостиниц.

• **Класс устойчивости PEI 4**

Глазурованные керамические напольные покрытия, по которым ходят в обычной обуви при средней интенсивности хождения, со средним абразивным загрязнением. Используются в торговых залах магазинов, коммерческих помещениях и офисах.

• **Класс устойчивости PEI 5**

Глазурованные керамические напольные покрытия, интенсивно используемые с высокой нагрузкой истирания. Используются в торговых залах магазинов, в ресторанах, у пультов и окошек обслуживания, в гаражах, в вокзалах и в залах аэропорта.



Odolnost proti hloubkovému opotřebení – obrusnost | Deep abrasion resistance Odporność na ścieranie wgłębne | Устойчивость к износу – глубокое абразивное истирание

CZ Odolnost proti hloubkovému opotřebení (odolnost proti obrusu) je schopnost neglazovaných keramických výrobků odolávat za stanovených podmínek abrazivním vlivům. Principem zkoušky je stanovení objemu obroušené hmoty střepu, způsobené na lícni ploše dlaždice brusnými účinky zkušebního přístroje, prováděné za stanovených podmínek podle normy EN ISO 10545-6. Doporučujeme použít dlaždice z programu TAURUS na místa, kde se předpokládá vysoké opotřebení dlažby (nádraží, podchody, supermarkety).

EN

Deep abrasion resistance (deep abrasive power) is ability of unglazed ceramic products to resist abrasion under specified conditions. Test principle is to determine the amount of material of the body on the tile face abraded away by grinding action of a test tool under specified conditions - according to standard EN ISO 10545-6. It is recommended to use the tiles of TAURUS serie for places with heavy loaded paving.

PL

Odporność na ścieranie wgłębne to zdolność nieszkliwionych płytek ceramicznych, w określonych warunkach, oparcia się działaniu substancji ściernych. W badaniu określa się objętość wytartego materiału czerepu na licowej powierzchni płytki przy użyciu aparatu do szlifowania, przeprowadzonego w określonych warunkach, zgodnie z normą EN ISO 10545-6. W ciągach komunikacyjnych o dużym natężeniu ruchu, zaleca się stosowanie płytek serii TAURUS.

RUS

Устойчивость к глубокому абразивному истиранию является свойством неглазурованной плитки при определенных условиях сопротивляться воздействию абразивных частиц. Принципом испытания является определение объема стертой поверхности лицевой стороны плитки, вызванного абразивным воздействием испытательного приспособления, при проведении в условиях, определенных стандартом EN ISO 10545-6. Рекомендуем использовать плитку серии TAURUS для участков, на которых предполагается сильный износ плитки.



Chemické vlastnosti | Chemical properties Właściwości chemiczne | Химические свойства

CZ Chemická odolnost podle EN ISO 10545-13

Chemická odolnost je posuzována podle EN ISO 10545-13. Keramické obkladové prvky jsou vystaveny působení zkušebních roztoků a podle vlivu zjištěného vizuálně po určitém časovém působení se dělí do níže uvedených tříd. Obkladové prvky LASSELSBERGER, s.r.o., odolávají působení chemikálií používaných v domácnosti a prostředkům na úpravu vody v bazénech podle EN ISO 10545-13. **Vybrané obkladové prvky se zvýšenou chemickou odolností zařazené do třídy A označené ikonou odolávají působení kyselin a louhů podle EN ISO 10545-13, ostatní obkladové prvky LASSELSBERGER, s.r.o., jsou zařazeny jako: min. B.**

Vodné zkušební roztoky

- Chemikálie používané v domácnosti: roztok chloridu amonného 100 g/l; soli na úpravu vody v bazénech: roztok chlornanu sodného 20 g/l

Třídy podle EN 14411:2016:

- A/B/C*

Kyseliny a louhy

- Nízké koncentrace (L)
 - a) roztok kyseliny chlorovodíkové 3 %
 - b) roztok kyseliny citronové 100 g/l
 - c) roztok hydroxidu draselného 30 g/l
- Vysoká koncentrace (H)
 - a) roztok kyseliny chlorovodíkové 18 %
 - b) roztok kyseliny mléčné 5 %
 - c) roztok hydroxidu draselného 100 g/l

Třídy podle EN 14411:2016:

- A/B/C*

* Třída A má nejvyšší odolnost, třída C nejnižší.

Odolnost proti skvrnám podle EN ISO 10545-14

Lícni plocha obkladových prvků je vystavena zkušebním roztokům skvrnotvorných látek po určitou dobu, poté se lícni plochy stanovenými způsoby očistí a vizuálně se posoudí změny. V návaznosti na výsledky se dlaždice zatřídí do pěti tříd.

Skvrnotvorné látky používané ke zkoušce

- zelená substance v oleji, červená substance v oleji, roztok jódu v alkoholu 13 g/l, olivový olej

Čištění

- Čisticí prostředky: horká voda (+55 °C), slabé čisticí prostředky (pH 6,5–7,5), silné čisticí prostředky (pH 9–10)
- Rozpouštěcí prostředky: roztok kyseliny chlorovodíkové 3%, roztok hydroxidu draselného 200 g/l, aceton

Třídy: 5/4/3/2/1*

* Třída 5 vykazuje nejvyšší odolnost proti skvrnám, klesající k třídě 1.

Uvolňování olova a kadmia podle EN ISO 10545-15

Množství uvolněného olova a kadmia se určuje na základě vylouhování glazované lícni plochy keramických obkladových prvků octovým roztokem.

EN Resistance to chemicals, EN ISO 10545-13

Chemical resistance is assessed according to EN ISO 10545-13. Ceramic tiles are exposed to test solutions and, depending on inspection results after a set period, they are divided into the following classes. LASSELSBERGER, s.r.o. tiles are resistant to household chemicals and agents for water treatment in swimming pools according to EN ISO 10545-13. **Selected tiles with increased chemical resistance, classified in Class A, designated with an icon are resistant to acids and alkali according to EN ISO 10545-13. Other LASSELSBERGER, s.r.o. tiles are classified as follows: min. B.**

Aqueous test solutions

- Household chemicals: ammonium chloride solution 100g/l; salts for water treatment in swimming pools: sodium hypochlorite solution 20 g/l

Classes according to EN 14411:2016:

- A/B/C*



Chemické vlastnosti | Chemical properties Właściwości chemiczne | Химические свойства

Acids and alkalis

- Low concentration (L)
 - a) hydrochloric acid solution 3%
 - b) citric acid solution 100 g/l
 - c) potassium hydroxide solution 30 g/l
- High concentration (H)
 - a) hydrochloric acid solution 18%
 - b) lactic acid solution 5%
 - c) potassium hydroxide solution 100 g/l

Classes according to EN 14411:2016:

- A/B/C*

* Class A shows the highest resistance to chemicals, which decreases more and more towards C.

Stain resistance, EN ISO 10545-14

Tile surfaces are exposed to test solutions of stain-forming substances for a set period, cleaned in the specified manner, and changes are visually assessed. Following the results, the tiles are classified into five classes.

Stain-forming substances used for testing

- Stain forming substances, leaving traces; green stain forming substances in oil; red stain forming substances in oil
- Chemical stain forming substances; iodine, 13 g/l in alcohol
- Stain forming substances, forming a film; olive oil

Cleaning

- Cleaning agent: hot water (+55 °C); weak cleaning agent (pH 6,5-7,5); strong cleaning agent agent (pH 9-10)
- Solvent: hydrochloric acid solution 3%; potassium hydroxide solution 200g/l; acetone

Classes: 5/4/3/2/1*

* Class 5 shows the highest stain resistance, which decreases more and more towards 1.

Lead and cadmium delivery, EN ISO 10545-15

The quantity of released lead and cadmium is determined on the basis of extraction of glazed tile faces with the acetic acid solution.

PL Odporność chemiczna określana jest zgodnie z normą EN ISO 10545-13

Odporność chemiczna jest oceniana na podstawie normy EN ISO 10545-13. Elementy ceramiczne poddawane są działaniu określonych roztworów, a następnie, na podstawie oceny wizualnej po określonym czasie, są zakwalifikowane do jednej z, poniżej przedstawionych, grup. Okładziny ceramiczne, produkcji LASSELSBERGER, s.r.o. są odporne na działanie środków chemicznych domowego użytku oraz soli basenowych, zgodnie z EN ISO 10545-13. **Wybrane elementy ceramiczne, o podwyższonej odporności chemicznej, zakwalifikowane do grupy A i oznaczone ikoną  są odporne na działanie kwasów i zasad, zgodnie z EN ISO 10545-13. Pozostała ceramika, produkcji LASSELSBERGER s.r.o. jest deklarowana, jako min. B.**

Roztwory do badań

- Chemikalia domowego użytku: chlorek amonu, roztwór 100 g/l, sole basenowe: podchloryn sodowy roztwór 20 mg/l

Klasy według EN 14411:2016:

- A/B/C*

Kwasy i zasady

- Nisko stężone (L)
 - a) roztwór kwasu solnego 3%
 - b) roztwór kwasu cytrynowego 100 g/l
 - c) wodorotlenek potasowy, roztwór 30 g/l
- Wysoko stężone (H)
 - a) roztwór kwasu solnego 18%
 - b) roztwór kwasu mlekowego 5%
 - c) wodorotlenek potasowy, roztwór 100 g/l

Klasy według EN 14411:2016:

- A/B/C*

* Klasa A oznacza najwyższą odporność chemiczną, odporność zmniejsza się konsekwentnie do klasy C, odpowiadającej najniższej odporności chemicznej.

Odporność na płamienie według EN ISO 10545-14

Licowa strona płytki poddawana jest działaniu środków paliących przez określony czas, następnie jest przemywana, ściśle określonymi metodami, a efekt jest oceniany wizualnie. Na podstawie uzyskanych wyników, płytki są klasyfikowane do pięciu grup.

Środki paliące stosowane w próbach

- Płamy zostawiające ślady, zielony środek paliący w lekkim oleju, czerwony środek paliący w lekkim oleju, płamy o utleniającym działaniu chemicznym jod roztwór alkoholowy, 13 g/l, płamy tworzące „film”, olej z oliwek,

Czyszczenie

- Środki czyszczące: ciepła woda (+55 °C), środek czyszczący lekko aktywny (pH 6,5-7,5), mocny środek czyszczący (pH 9-10)
- Stosowane rozpuszczalniki: kwas solny 3%, roztwór tugu potasowego 200 g/l, aceton

Klasy: 5/4/3/2/1*

* Klasy 5 odpowiadają płytce, w której najłatwiej jest usunąć widoczne zabarwienie, o najwyższej odporności na płamienie, odporność zmniejsza się konsekwentnie do klasy 1, odpowiadającej najniższej odporności na płamienie.

Uwalnianie ołowiu i kadmu według EN ISO 10545-15

Ilości uwalnianego ołowiu i kadmu określa się na podstawie ekstrakcji roztworem kwasu octowego z licowej warstwy szkliwa.

RUS Химическая устойчивость согласно норме EN ISO 10545-13

Химическая стойкость плитки оценивается по стандарту EN ISO 10545-13. Ceramiczne облицовочные элементы подвергаются воздействию испытательных растворов и в зависимости от установленного в ходе визуального контроля воздействия относятся к нижеуказанным классам. Облицовочные элементы, производимые компанией LASSELSBERGER, s.r.o., являются стойкими к воздействию домашней химии, а также к воздействию средств, применяемых в бассейнах для обработки воды, согласно EN ISO 10545-13. **Некоторые облицовочные элементы, с повышенной химической стойкостью, отнесены к классу «А» и обозначаются иконкой  данные облицовочные элементы являются стойкими к воздействию кислот и щелочей согласно требованиям стандарта EN ISO 10545-13, остальные облицовочные элементы, производимые компанией LASSELSBERGER, s.r.o., отнесены к категориям: мин. В.**

Растворы для испытаний на основе воды

- Средства домашней химии: раствор хлористого аммония 100 г/л; Соли для обработки воды в бассейнах: раствор хлористого натрия 20 г/л

Классы согласно EN 14411:2016:

- A/B/C*



Chemické vlastnosti | Chemical properties Właściwości chemiczne | Химические свойства

Кислоты и щелочи:

- Минимальная концентрация (L)
 - a) раствор соляной кислоты 3%
 - b) раствор лимонной кислоты 100 г/л
 - c) раствор гидроксида калия 30 г/л
- Высокая концентрация (H)
 - a) раствор соляной кислоты 18%
 - b) раствор молочной кислоты 5%
 - c) раствор гидроксида калия 100 г/л

Классы согласно EN 14411:2016:

- A/B/C*

* Класс А имеет наибольшую устойчивость, которая постепенно снижается к классу С.

Устойчивость против образования пятен согласно EN ISO 10545-14

Лицевая поверхность облицовочных элементов подвергается воздействию испытательных растворов веществ, образующих пятна, на протяжении определенного периода времени, после чего лицевая поверхность определенным образом очищается и выполняется визуальная оценка произошедших изменений поверхности. В зависимости от результатов напольная плитка разбивается по пяти категориям.

Применяемые в ходе испытания вещества, образующие пятна

- Химические вещества, вызывающие образование пятен: зеленые пятна от масла, красные пятна от масла, йод, 13 г/л в спирте, химические вещества, оставляющие пленку, оливковое масло.

Чистка

- Горячая вода (+55 °C), слабые чистящие средства (pH 6,5-7,5), сильные чистящие средства (pH 9-10)
- Растворители: раствор соляной кислоты 3%; раствор едкого калия 200 г/л; ацетон

Классы: 5/4/3/2/1*

* Класс 5 имеет наибольшую устойчивость к образованию пятен, класс 1 имеет устойчивость наименьшую.

Выделение свинца и кадмия согласно норме EN ISO 10545-15

Количество выделенного олова и кадмия определяется после выщелачивания уксусным раствором глазурованной лицевой поверхности керамических облицовочных элементов.

Elektrické vlastnosti | Electrical properties | Własności elektrostatyczne | Электрические характеристики

CZ

Pro podlahy operačních sálů, laboratoří, výroby léčiv, výbušných látek a mikroelektroniky jsou předepisovány antistatické podlahy. Keramické dlaždice jsou elektrickými izolanty, proto se svedení elektrického náboje provádí vodivými spárami mezi malými nebo mozaikovými dlaždicemi. Bližší informace na www.rako.cz – projektový tým.

EN

Antistatic flooring is required for floors of operating theatres, laboratories, production of medical and pharmaceutical products, explosive substances and microelectronics. Ceramic tiles belong among electrical insulators, therefore, electric charge is discharged using conductive joints between small or mosaic tiles.

PL

W salach operacyjnych, laboratoriach, przy produkcji leków, materiałów wybuchowych, czy mikroelektroniki, wymagane są posadzki antyelektrostatyczne. Płytki ceramiczne są izolatorami, stąd do odprowadzenia ładunku elektrycznego stosuje się przewodzące spoiny pomiędzy małymi płytkami, bądź ceramiczną mozaiką.

RUS

Удля полов в операционных залах, лабораториях, предприятиях по производству лекарств, взрывоопасных веществ и микроэлектроники предъявляются требования по антистатическим свойствам. Керамическая плитка является электрическим изолятором, поэтому электрический заряд сводится токопроводящими швами между малоформатной или мозаичной плиткой.

Hygienické vlastnosti | Hygienic properties | Własności higieniczne | Санитарно-гигиенические характеристики

CZ

Výrobky LASSELSBERGER, s.r.o., jsou pravidelně testovány na radiačně-hygienickou nezávadnost v souladu s vyhláškou Státního úřadu pro jadernou bezpečnost č. 307/2002 Sb., v aktuálním znění zákona č. 13/2002 Sb. Výrobky LASSELSBERGER, s.r.o., splňují výše uvedené požadavky a jsou nezávadné.

Keramické prvky LASSELSBERGER, s.r.o., jsou pravidelně testovány na vyluhování olova (Pb) a kadmia (Cd) z glazur podle EN ISO 10545-15. Provedené rozborly potvrzují zdravotní nezávadnost keramických obkladových prvků LASSELSBERGER, s.r.o., viz prohlášení o vlastnostech na www.rako.cz – ke stažení – prohlášení o vlastnostech.

Pro vybrané výrobky TAURUS, ColorTWO a POOL jsou na www.rako.cz – ke stažení – certifikáty k dispozici atesty na hygienickou nezávadnost ve styku s potravinami a pitnou vodou, které vypracovala nezávislá hygienická zkušebna.

Keramické obklady stěn a podlah včetně keramických tvarovek, zaoblených soklů s požlábkem ColorTWO nebo TAURUS a potravinářského soklu TAURUS GRANIT mají číslo rádius R 44 se snadno udržují, a umožňují tak splnit přísné hygienické požadavky v potravinářských a zdravotnických zařízeních. Jsou vhodné všude tam, kde je zapotřebí zajistit plochy bez choroboplodných zárodků, plísní, prachu a nečistot.

V bytech lze vhodnou aplikací keramických obkladových prvků na podlahy i stěny zlepšit mikroklima, např. snížit výskyt prachu, pylu a roztočů.

Hygienické vlastnosti | Hygienic properties | Właściwości higieniczne | Санитарно-гигиенические характеристики

EN LASSELSBERGER, s.r.o. products are regularly tested for radiation-hygienic safety as per the Decree by the State Office for Nuclear Safety 307/2002 Coll., as amended by Act 13/2002 Coll. LASSELSBERGER, s.r.o. products meet the requirements mentioned above, and they are safe. Ceramic products LASSELSBERGER, s.r.o. are regularly tested for release of lead (Pb) and cadmium (Cd) from glazes according to EN ISO 10545-15. The performed analyses prove the ceramic tiles by LASSELSBERGER, s.r.o., are harmless for human health, see the statement of properties on www.rako.eu – download – Declaration of Performance.

Selected TAURUS, ColorTWO and POOL products have attests of sanitary harmlessness in contact with food and drinking water on www.rako.eu – download – Certificates, prepared by an independent sanitary laboratory.

Ceramic wall and floor tiles including shaped pieces, rounded mouldings with corrugation ColorTWO or TAURUS and TAURUS GRANIT base moulding for food processing areas with radius R44 of the rounding are easy to maintain, thus allowing for compliance with the strict hygienic requirements for food processing plants and healthcare facilities. They are suitable for all types of applications requiring surfaces free of pathogenic germs, moulds, dust, and other pollutants.

Suitable application of ceramic tiles on floors and walls can also improve the home microclimate, e.g. reduce occurrence of dust, pollen and mites.

PL Produkty LASSELSBERGER, s.r.o., są regularnie badane na naturalną promieniotwórczość, zgodnie z rozporządzeniem Rady Ministrów z dn. 2.1.2007 (Dziennik Ustaw Nr.4 poz.29). Produkty LASSELSBERGER, s.r.o., spełniają powyższe wymagania i są bezpieczne.

Produkty LASSELSBERGER, s.r.o., są regularnie badane na uwalnianie ołowiu (Pb) i kadmu (Cd) ze szkliwa, zgodnie z normą EN ISO 10545-15. Przeprowadzane analizy potwierdzają bezpieczeństwo płytek ceramicznych LASSELSBERGER, s.r.o., dla zdrowia, patrz: deklaracja właściwości użytkowych na www.rako.cz - do ściągnięcia - Deklaracja właściwości użytkowych.

Na www.rako.cz - do ściągnięcia - Certyfikaty, dostępne są Atesty Higieniczne PZH potwierdzające przeznaczenie płytek dla służby zdrowia, przemysłu spożywczego, budownictwa mieszkaniowego, czy sportowego.

Ceramiczne płytki ściienne i podłogowe, w tym kształtki ceramiczne, zaokrąglone cokoty z rowkiem ColorTWO i TAURUS, cokol-rowek TAURUS GRANIT o promieniu R 44, są łatwe w utrzymaniu czystości i pozwalają spełniać rygorystyczne wymagania higieniczne przetwórstwa żywności oraz placówek medycznych. Nadają się wszędzie tam, gdzie wymagane są powierzchnie wolne od zarazków chorobotwórczych, pleśni, kurzu i brudu.

W mieszkaniach, zastosowanie płytek ceramicznych na podłogach i ścianach poprawia mikroklimat, np. zmniejszając występowanie kurzu, pyłków i roztoczy.

RUS Продукция компании «LASSELSBERGER, s.r.o.» регулярно тестируется на радиационно-гигиеническую безвредность согласно требованиям, содержащимся в инструкции Государственного управления по ядерной безопасности № 307/2002 Сб. законов, в действующей редакции закона № 13/2000 Сб. законов. Продукция компании «LASSELSBERGER, s.r.o.» полностью соответствует вышеуказанным требованиям и является безвредной.

Керамические элементы производства компании «LASSELSBERGER, s.r.o.» регулярно тестируются на выделение свинца (Pb) и кадмия (Cd) из глазури согласно EN ISO 10545-15. Выполненные анализы подтверждают безопасность продукции компании «LASSELSBERGER, s.r.o.», см. сертификаты свойств на www.rako.eu, в разделе «Скачать» - «Сертификаты свойств».

Для выбранных изделий серии TAURUS, ColorTWO и POOL на сайте www.rako.cz, в разделе «Скачать» - «Сертификаты» приведены сертификаты санитарно-гигиенической безвредности продукции при контакте с пищевыми продуктами и питьевой водой, выданные независимой санитарно-гигиенической лабораторией.

Керамическая настенная и напольная плитка, включая фасонные изделия, угловую плитку серии ColorTWO или TAURUS и цоколи TAURUS GRANIT с радиусом закругления R 44, предназначенные для применения на предприятиях пищевой промышленности, проста в уходе и позволяет соблюдать жесткие санитарно-гигиенические требования, предъявляемые на предприятиях пищевой промышленности и в медицинских учреждениях. Данная продукция пригодна для применения повсюду, где необходимо обеспечить чистоту поверхности и отсутствие возбудителей болезней, плесени, пыли и других загрязнений.

В квартирах правильное применение керамических облицовочных элементов для оформления полов и стен позволяет улучшить микроклимат, например, уменьшить образование пыли, пыльцы и размножение пылевых клещей.

Teplné vlastnosti | Thermal characteristics | Właściwości termiczne | Тепловые свойства

CZ Všechny typy dlaždic LASSELSBERGER, s.r.o., jsou pro své výhodné tepelné vlastnosti (vodivost a akumulace tepla) ideální podlahovou krytinou pro podlahové vytápění.

Srovnání tepelné vodivosti podlahových krytin:

Keramika	1,03 W/(m·K)
Dřevo	0,22 W/(m·K)
PVC/Vinyl	0,19 W/(m·K)
Koberec	0,07 W/(m·K)

Koeficient tepelné roztažnosti obkládaček a dlaždic je velmi nízký, přesto je nutné provádět dilatační spáry. Koeficient tepelné roztažnosti keramických obkladů a dlažeb (λ) v intervalu 20–100 °C je 4–8·10⁻⁶ K⁻¹.

Příklad funkce tepelné roztažnosti na dilatačním poli délky 6 m (L) při rozdílu teplot 50 °C (Δt):

Délková změna keramické dlažby = $\lambda \times L \times \Delta t = 0,000008 \times 6\,000 \times 50 = 2,4\text{ mm}$.

EN Thanks to their convenient thermal properties (conductivity and heat accumulation), all types of LASSELSBERGER, s.r.o. tiles are ideal floor coverings on underfloor heating.

Comparison of thermal conductivity of floor coverings:

Ceramics	1.03 W/(m·K)
Wood	0.22 W/(m·K)
PVC/Vinyl	0.19 W/(m·K)
Carpet	0.07 W/(m·K)

Even though the thermal expansion coefficient of wall and floor tiles is very low, it is necessary to carry out dilatation joints. Thermal expansion coefficient of ceramic wall and floor tiles (λ) at the interval of 20–100°C is 4–8·10⁻⁶ K⁻¹.

An example of thermal expansion functions at a dilation field in a length of 6 meters (L) at a temperature difference of 50°C (Δt):

Length change of ceramic tiles = $\lambda \times L \times \Delta t = 0.000008 \times 6\,000 \times 50 = 2.4\text{ mm}$.

Teplné vlastnosti | Thermal characteristics | Właściwości termiczne | Тепловые свойства

PL Wszystkie rodzaje płytek, produkcji LASSELSBERGER, s.r.o., z uwagi na ich właściwości termiczne (przewodnictwo i magazynowania ciepła) są idealną okładziną na ogrzewania podłogowe.

Porównanie przewodnictwa cieplnego okładzin podłogowych:

Ceramika	1,03 W / (m·K)
Drewno	0,22 W / (m·K)
PCW / Winył	0,19 W / (m·K)
Dywan	0,07 W / (m·K)

Współczynnik rozszerzalności cieplnej płytek jest bardzo niski, jednak wymaga wykonania szczelin dylatacyjnych. Współczynnik rozszerzalności cieplnej płytek ceramicznych (λ) w zakresie 20-100 °C wynosi 4–8·10⁻⁶ K⁻¹.

Przykład rozszerzalności cieplnej w polu dylatacyjnym o długości 6 m (L), przy różnicy temperatur wynoszącej 50 °C (Δt):

Zmiana wymiarów płytek ceramicznych = $\lambda \times L \times \Delta t = 0,000008 \times 6\,000 \times 50 = 2,4\text{ mm}$.

RUS Все типы напольной плитки, производимой компанией LASSELSBERGER, s.r.o., благодаря отличным термическим свойствам плитки (теплопроводность и аккумуляция тепла) являются идеальным материалом для устройства теплых полов.

Сравнение теплопроводности напольных материалов:

Керамика	1,03 Вт/(м·K)
Древесина	0,22 Вт/(м·K)
ПВХ / Винил	0,19 Вт/(м·K)
Ковер	0,07 Вт/(м·K)

Коэффициент теплового расширения настенной и напольной плитки является очень низким, тем не менее, необходимо предусматривать устройство расширительных швов. Коэффициент теплового расширения керамической настенной и напольной плитки (λ) при температуре 20–100 °C составляет 4–8·10⁻⁶ K⁻¹.

Пример работы теплового расширения на участке длиной 6 м (L) при разнице температур 50 °C (Δt):

Общее изменение длины керамической напольной плитки = $\lambda \times L \times \Delta t = 0,000008 \times 6\,000 \times 50 = 2,4\text{ мм}$.



Protiskluznost | Slip resistance | Przeciwoślizgowość | Устойчивость к скольжению

CZ Jedná se o jednu z nejdůležitějších povrchových vlastností keramických dlaždic, která určuje vhodnost použití vybraného typu dlaždic pro konkrétní prostory a zajišťuje bezpečný pohyb osob. Požadavky na protiskluznost podlah určují národní předpisy, např. v ČR vyhláška 268/2009 Sb. a norma pro podlahy ČSN 74 4505 a k upřesnění jsou vhodné bezpečnostní předpisy ASR A1.5/1, 2, které lze doporučit pro objekty v celé Evropě (viz Tab. 4).

Protiskluznost se u keramických dlaždic hodnotí pomocí metod stanovených v následujících normách:

- CEN/TS 16 165:2012 Determination of slip resistance of pedestrian surfaces – Methods of evaluation, Stanovení protiskluznosti
- DIN 51 097 Stanovení protiskluznosti pro mokré povrchy v prostorách, kde se chodí bosou nohou
- DIN 51 130:2014-02 Stanovení protiskluznosti pro pracovní prostory a plochy se zvýšeným nebezpečím uklouznutí
- ČSN 72 5191 Stanovení protiskluznosti
- ASR A1.5/1, 2 Bezpečnostní předpis

V následujících tabulkách je uveden přehled testovaných hodnot protiskluznosti dlaždic RAKO HOME a RAKO OBJECT.

EN This is one of the most important surface properties of ceramic floor tiles, which determines the suitability of selected floor tiles for a particular room, and which guarantees safe movement of people. Requirements on the anti-slip properties of floors are specified by national regulations, for example in the Czech Republic by Public Notice No. 268/2009 and the ČSN 74 4505 floor standard, which should be complemented by safety regulations ASR A1.5/1, 2, which can be recommended for buildings throughout Europe (see Table 4).

In Germany, these requirements are set out in Technische Regel für Arbeitsstätten – ASR A1.5/1, 2: Fußböden

Slip resistance of the ceramic tiles is determined by the method stated by the following standards:

- CEN/TS 16 165:2012 Determining slip resistance of pedestrian surfaces – Methods of evaluation, Determining slip resistance
- DIN 51 097 Determination of sliding properties for wet surfaces for bare foot
- DIN 51 130:2014-02 Determination of sliding properties for working areas and surfaces with increased risk of slip
- ASR A1.5/1, 2 Safety regulations

According to ČSN 72 5191 and Regulation ASR A1.5/1, 2 [DIN 51 130:2014-02] anti-slip floor tiles according to their slip angle for work floors should be used.

PL Jest jedną z najważniejszych właściwości powierzchniowych ceramicznych płytek podłogowych, która określa przydatność wybranego typu płytek podłogowych w konkretnych miejscach i zapewnia bezpieczne poruszanie się osób. Wymagania dotyczące przeciwoślizgowości podłóg określają przepisy krajowe, np. rozporządzenie Ministra Pracy i Polityki Socjalnej w sprawie ogólnych przepisów bezpieczeństwa i higieny pracy (Dz.U. 169/2003 poz. 1650) oraz rozporządzenie Ministra Infrastruktury w warunków technicznych, jakim powinny odpowiadać budynki i ich usytuowanie (Dz. U. 75/2002 poz. 690) a dla sprecyzowania są wskazane przepisy bezpieczeństwa ASR A1.5/1, 2, które można zalecić dla obiektów w całej Europie (patrz tab. 4). W Niemczech obowiązują wymagania Regel für Arbeitsstätten - ASR A1.5/1, 2: Fußböden

Przeciwoślizgowość płytek ceramicznych ocenia się według metod określonych w niżej podanych normach:

- CEN/TS 16 165:2012 Determination of slip resistance of pedestrian surfaces – Methods of evaluation, Określanie skuteczności przeciwoślizgowej
- DIN 51 097 Ustalenie przeciwoślizgowości mokrych powierzchni w pomieszczeniach, w których chodzi się bosą
- DIN 51 130:2014-02 Ustalenie przeciwoślizgowości przestrzeni roboczych i powierzchni roboczych z podwyższonym niebezpieczeństwem poślizgu
- ASR A1.5/1, 2 Przepis bezpieczeństwa

Z rosnącymi wymogami przeciwoślizgowości często połączony jest wymóg nakładany na zdolność powierzchni reliefowych do zatrzymania pewnej ilości cieczy rozlanej na podłogę we wgłębieniach (najczęściej występuje to w przetwórnach tłuszczu itp.). Zdolność drenażowa określona jest w normie DIN 51 130:2014-02 jako objętość wgłębienia reliefu w cm³, odniesiona do powierzchni 1 dm² płytki. Oznaczana jest literą V i liczbą.



RUS Речь идет об одном из наиболее важных свойств поверхности керамической напольной плитки, определяющем пригодность применения данного типа напольной плитки для конкретных помещений и обеспечивающем безопасность лиц. Требования, предъявляемые к противоскользящим свойствам полов, определены в законодательстве конкретных стран, например, в Чешской Республике нормативными документами являются Постановление № 268/2009 Сб. законов и стандарт для полов ČSN 74 4505, для уточнения требований применяются правила безопасности ASR A1.5/1, 2, которые можно рекомендовать для объектов по всей Европе (см. таб. 4).

В Германии требования определены в документах: Technische Regel für Arbeitsstätten - ASR A1.5/1, 2: Fußböden

Устойчивость к скольжению определяется при помощи методов, приведенных в данных нормативах:

- CEN/TS 16 165:2012 Determining slip resistance of pedestrian surfaces – Methods of evaluation, Determining slip resistance
- DIN 51 097 Определение устойчивости к скольжению для мокрой поверхности при применении в помещениях, для хождения босиком
- DIN 51 130:2014-02 Определение устойчивости к скольжению для рабочих помещений и поверхностей с повышенной опасностью скольжения
- ASR A1.5/1, 2 Инструкция по безопасности

С повышенными требованиями к устойчивости к скольжению часто связано и требование на дренажную способность рельефных поверхностей, т.е. способность отвести с контактной поверхности определенное количество жидкости, вылитой на пол (чаще всего в производствах по переработке жиров). Данное свойство в норме DIN 51 130:2014-02 определено при помощи объема впадины профиля в см³, к площади плитки в 1 дм² (дренажное пространство). Обозначается буквой V и соответствующим числом (напр. V4).

Tab. 4

Přehled požadavků na protiskluznost podlah Overview of requirements for anti-slip floors				
Předpis Regulation	Požadovaná hodnota Required value	Země Country	Oblast použití Field of application	Hodnoty a označení LASSELSBERGER, s.r.o.
vyhl. 268/2009 Sb. ČSN 74 4505 Podlahy Decree 268/2009 Coll. CSN 74 4505 Floors	součinitel smykového tření sliding friction coefficient $\mu \geq 0,3$	ČR CR	podlahy bytových a pobytových místností Floors of apartment and residential rooms	všechny dlaždice LASSELSBERGER, s.r.o. All floor tiles LASSELSBERGER, s.r.o.
vyhl. 268/2009 Sb. ČSN 74 4505 Podlahy Decree 268/2009 Coll. CSN 74 4505 Floors	součinitel smykového tření sliding friction coefficient $\mu \geq 0,5$	ČR CR	podlahy staveb užívaných veřejností Floors of buildings for public use	dlaždice označené ikonami viz Technický katalog www.rako.cz Floor tiles LB marked with icons see the Technical Catalogue www.rako.eu
vyhl. 398/2009 Sb. ČSN 73 4130 Schodiště a šikmé rampy Decree 398/2009 Coll. CSN 73 4130 Staircases and sloping ramps	Pro schodiště: součinitel smykového tření na pochozí ploše schodiště $\mu \geq 0,5$, na předním okraji schodišťového stupně do vzdálenosti 4 cm od hrany $\mu \geq 0,6$ Pro rampy: součinitel smykového tření $\mu \geq 0,5 + tg \alpha$ For staircases: sliding friction coefficient on a walking staircase surface $\mu \geq 0,5$, on a front edge of parallel treads up to the distance of 4 cm from the edge $\mu \geq 0,6$ For ramps: sliding friction coefficient $\mu \geq 0,5 + tg \alpha$	ČR CR	schodiště a šikmé rampy pro osoby s omezenou schopností pohybu staircases and sloping ramps for people with limited mobility	vybrané dlaždice viz Technický katalog nebo www.rako.cz Selected floor tiles see the Technical Catalogue or www.rako.eu
ČSN EN 13451-1 Plavecké bazény EN 13451-1 Swimming pools ASR 1.5/1, 2 Bezpečnostní předpis Německo ASR 1.5/1, 2 Safety regulations (Germany) DIN 51 097	úhel kluzu > 12° slip angle > 12°	EU, ČR EU, CR	šatny, chodby pro chůzi na boso... Changing rooms, corridors for barefoot walking...	dlaždice označené ikonou Floor tiles marked with icon
	úhel kluzu > 18° slip angle > 18°	EU, ČR EU, CR	veřejné sprchy, ochozy bazénů, brouzdaliště, schody... Public showers, pool decks, paddling pools, stairs...	dlaždice označené ikonou Floor tiles marked with icon
	úhel kluzu > 24° slip angle > 24°	EU, ČR EU, CR	startovací bloky, schody do vody, šikmé okraje bazénů... Starting blocks, water stairs, inclined pool sides, underwater stairs	dlaždice označené ikonou Floor tiles marked with icon
ASR A1.5 Bezpečnostní předpis DIN 51 130:2014-02 Safety regulations ASR A1.5/1,2 DIN 51 130:2014-02	úhel kluzu 6 až 35° slip angle from 6 to 35°	Německo, EU doporučeno pro ČR Germany, EU recommended for CR	podlahy staveb užívaných veřejností Floors of buildings for public use	dlaždice označené ikonami viz katalog RAKO OBJECT Floor tiles marked with icons see the RAKO OBJECT Catalogue



Protiskluzné vlastnosti keramických dlaždic RAKO HOME podle CEN/TS 16 165:2012 (ČSN 72 5191) Anti-slip characteristics of ceramic tiles RAKO HOME according to CEN/TS 16 165:2012

Program Série	Koeficient tření		DIN 51 130	DIN 51 097
	μ za sucha	μ za mokra		
Podlahy 2018			R	(A, B, C)
Alba (DAR...)	$\geq 0,6$	$\geq 0,5$	R10	A
Alba (DDM06...)	$\geq 0,6$	$\geq 0,5$	R10	B
Alba (DDPSE...)	$\geq 0,6$	$\geq 0,5$	R9	-
Alba lappato (DAP...)	$\geq 0,6$	$\geq 0,5$	R9	-
Base (DAK...)	$\geq 0,5$	$\geq 0,3$	R9	A
Base (DAR...)	$\geq 0,6$	$\geq 0,5$	R10	B
Base (DDM06...)	$\geq 0,6$	$\geq 0,5$	R10	B
Board (DAK...)	$\geq 0,6$	$\geq 0,5$	R9	A
Board (DDM06..., DDPSE...)	$\geq 0,6$	$\geq 0,5$	R10	A
Cemento (DAK...)	$\geq 0,6$	$\geq 0,5$	R9	-
Cemento (DAR..., DDM06...)	$\geq 0,6$	$\geq 0,5$	R10	B
Cemento (DDPSE...)	$\geq 0,6$	$\geq 0,5$	R10	A
Cemento (DAG...)	$\geq 0,7$	$\geq 0,6$	R11	C
Clay	$\geq 0,6$	$\geq 0,5$	R9	-
Clay (DDM06...)	$\geq 0,6$	$\geq 0,5$	R10	A
Como (DAR3B..., DDP3B...)	$\geq 0,6$	$\geq 0,5$	R9	A
Como (DDM05...)	$\geq 0,6$	$\geq 0,5$	R10	A
Concept	$\geq 0,6$	$\geq 0,5$	R9	-
Defile (DAA...)	$\geq 0,6$	$\geq 0,5$	R9	-
Defile (DDM06...)	$\geq 0,7$	$\geq 0,6$	R10	B
Era	$\geq 0,6$	$\geq 0,5$	R9	A
Era (DDM05...)	$\geq 0,7$	$\geq 0,6$	R10	B
Extra	$\geq 0,6$	$\geq 0,5$	R9	A
Extra (DAR12..., DDM06...)	$\geq 0,6$	$\geq 0,5$	R10	B
Faro	$\geq 0,6$	$\geq 0,5$	R9	A
Faro (DDM06...)	$\geq 0,6$	$\geq 0,5$	R10	B
Fashion	$\geq 0,6$	$\geq 0,5$	R9	A
Fashion (DDMBG...)	$\geq 0,6$	$\geq 0,5$	R10	A
Form (DAA..., DAR...), ((DDP3B...))	$\geq 0,6$	$\geq 0,5$	R9	A
Form (DDM05..., DDR05...)	$\geq 0,6$	$\geq 0,5$	R10	A
Garda	$\geq 0,6$	$\geq 0,5$	R9	A
Geo	$\geq 0,7$	$\geq 0,5$	R10	A
Geo (DDP44...)	$\geq 0,7$	$\geq 0,6$	R10	B
Golem	$\geq 0,6$	$\geq 0,3$	R9	-
Kaamos (DAA..., DAK...)	$\geq 0,6$	$\geq 0,5$	R10	A
Kaamos (DAK12..., DDM06...)	$\geq 0,6$	$\geq 0,5$	R10	B
Pebbles	$\geq 0,7$	$\geq 0,6$	R10	B
Pietra	$\geq 0,6$	$\geq 0,5$	R10	A
Pietra (DDPSE...)	$\geq 0,7$	$\geq 0,6$	R10	B
Random (DAK...)	$\geq 0,6$	$\geq 0,5$	R9	A
Random (DDM06...)	$\geq 0,6$	$\geq 0,5$	R10	A
Rock (DAA..., DAK..., DDVSE...)	$\geq 0,6$	$\geq 0,5$	R10	A
Rock (DAK12..., DAK1D..., DDM06..., DDP34...)	$\geq 0,7$	$\geq 0,6$	R10	B
Rock lappato (DAP...)	$\geq 0,6$	$\geq 0,5$	R9	-
Samba	$\geq 0,6$	$\geq 0,5$	R9	A
Sandstone Plus	$\geq 0,6$	$\geq 0,5$	R9	A
Sandstone Plus (DDM06...)	$\geq 0,7$	$\geq 0,6$	R10	B
Sandstone Plus lappato (DAP..)	$\geq 0,6$	$\geq 0,5$	R9	-
Sandy (DAK...)	$\geq 0,6$	$\geq 0,5$	R9	-
Sandy (DAR..., DDPSE...)	$\geq 0,6$	$\geq 0,5$	R10	B
Sidney	$\geq 0,6$	$\geq 0,4$	R9	-
Siena	$\geq 0,6$	$\geq 0,4$	R9	-
Siena (DDP44...)	$\geq 0,6$	$\geq 0,5$	R9	A
Spirit	$\geq 0,6$	$\geq 0,4$	R9	-
Stones (DAK...)	$\geq 0,6$	$\geq 0,5$	R10	A
Stones (DAR..., DD...)	$\geq 0,6$	$\geq 0,5$	R10	B
Stones lappato (DAP...)	$\geq 0,6$	$\geq 0,5$	R9	-
Stones (DAG...)	$\geq 0,7$	$\geq 0,6$	R11	C
Travertin	$\geq 0,6$	$\geq 0,5$	R10	A
Trend	$\geq 0,6$	$\geq 0,5$	R9	A
Trend (DAK12..., DDM06..., DDM0U...)	$\geq 0,6$	$\geq 0,5$	R10	B
Trend (DDPSE...)	$\geq 0,6$	$\geq 0,5$	R10	A
Unistone (DAA..., DAK...)	$\geq 0,6$	$\geq 0,5$	R9	-
Unistone (DAR..., DDP...)	$\geq 0,6$	$\geq 0,5$	R10	A
Unistone (DAR12..., DAR1D..., DDM0...)	$\geq 0,6$	$\geq 0,5$	R10	B
Via	$\geq 0,6$	$\geq 0,5$	R9	A
Via Mosaik (DDM05...)	$\geq 0,7$	$\geq 0,6$	R10	B

Přehled protiskluzných vlastností je uveden také na: www.rako.cz – ke stažení – prohlášení o vlastnostech
Protiskluznost schodových a balkonových tvarovek odpovídá stupni protiskluzu základních dlaždic dané série.



Protiskluznost | Slip resistance | Przeciwpślizgowość | Устойчивость к скольжению



Pro **pracovní podlahy** je podle ČSN 725191 a předpisu ASR A1.5/1, 2 (DIN 51 130:2014-02) vhodné volit protiskluzné dlaždice podle úhlu skluzu. According to ČSN 72 5191 and Regulation ASR A1.5/1, 2 (DIN 51 130:2014-02) anti-slip floor tiles according to their slip angle for **work floors** should be used.

Úhel skluzu Slip angle	Označení Identifier	Použití Application
6 – 10°	R9	vnitřní a odpočinkové plochy, kantýny, kanceláře, chodby úřadů, škol, administrativních budov, nemocnic... reception or waiting rooms, canteens, offices, corridors of official buildings, schools, administrative buildings, and hospitals...
10 – 19°	R10	sklady, malé kuchyně, sanitární prostory... Store rooms, small kitchens, sanitary rooms...
19 – 27°	R11	kuchyně škol, mycí linky, prádelny, vchody a venkovní schody... School kitchens, wash lines, laundries, entrances and outdoor staircases...
27 – 35°	R12	velkokuchyně, pracovní jámy, mlékárny... Large kitchens, work pits, dairies...
> 35°	R13	rafinerie tuků, koželuzny, jatka... Fat refineries, tanneries, abattoirs...



Pro podlahy, kde se chodí **bosou nohou**, jsou podle CEN/TS 16 165:2012, EN 13451-1, DIN 51 097, a ČSN 72 5191 stanoveny třídy protiskluznosti podle oblasti použití:

For floors for **barefoot** walking, according to CEN/TS 16 165:2012, EN 13451-1, DIN 51 097 and ČSN 72 5191, there are the following slip resistance classes according to the fields of application:

Úhel skluzu Slip angle	Označení Identifier	Použití Application
> 12°	A	převážně suché chodby, převlékárny, šatny, dna bazénů od 80 do 135cm, suchá sauna... mainly dry corridors, changing rooms, dressing rooms, bottoms of pools from 80 up to 135cm, dry saunas...
> 18°	B	veřejné sprchy, ochozy bazénů, brouzdaliště, schody, dna bazénů do 80cm, dna bazénů se sklonem do 8° a hloubkou do 135 cm, parní sauna... public showers, pool decks, paddling pools, stairs, bottoms of pools up to 80cm, bottoms of pools with a slope up to 8° and the maximum depth of 135cm, steam saunas...
> 24°	C	schody pod vodou, šikmé okraje bazénů, startovací bloky, dna bazénů se sklonem nad 8° a hloubkou do 135 cm, nášlapné plochy tobogánů... underwater stairs, inclined pool sides, starting blocks, bottoms of pools with a slope over 8° and the maximum depth of 135cm, walking areas of chute slides...

Pro podlahy s vysokými nároky na protiskluznost doporučuje vhodný reliéf předpis ASR A1.5/1, 2, kde např. v potravinářství a velkokuchyních musí reliéfní povrch dlaždic pojímat do prohlubní reliéfu určité množství tuků, nebo jiných látek. Podle druhu a výšky reliéfu se podle DIN 51 130:2014-02 označuje tzv. výtlačný prostor v cm³ na 1 dm² a označuje se písmenem V a příslušným číselným údajem (např. V4), viz tabulka:

For floors with high requirements for slip resistance, the ASR A1.5/1, 2 regulation recommends appropriate embossment, where, for example in food industry or industrial kitchens, the embossed surface of tiles must be able to accommodate a certain amount of fat or other substances into its cavities. Depending on the type and height of the embossment, a so-called discharge volume in cm³ per 1 dm² is defined in accordance with DIN 51 130:2014-02, and designated by the V letter and the corresponding numerical value (for example: V4), see the table:

Min. výtlačný objem v cm ³ /dm ² Min. discharge volume in cm ³ /dm ²	Označení Identifier
> 4	V4
> 6	V6
> 8	V8
> 10	V10



Údržba | Maintenance Utrzymanie czystości | Уход

CZ Údržba a čištění keramických obkladů a dlažeb

Pravidelné a správné čištění je nedílnou součástí péče o obklady a dlažbu. Postup a čisticí prostředky je třeba správně zvolit podle charakteru znečištění, druhu povrchu a metody čištění. Při čištění keramických materiálů je nutno rozlišovat

postavební úklid – čištění po dokončení stavby,

periodický úklid – běžný pravidelný úklid,

generální úklid – provádí se 1–2x za rok.

Podle velikosti a druhu čištené plochy lze zvolit čištění ručním kartáčem, hadrem, padem, mopem nebo pro velké plochy je vhodné zvolit kotoučové čisticí a vysávací stroje nebo vysokotlaké čisticí stroje. Vysokotlaké čističe s rozstříkacím injektorem jsou vhodné na silně znečištěné a protiskluzné povrchy. Nezávisle na zvoleném druhu čištění je nutno dávat pozor na to, aby uvolněná špína, která se během čištění rozpustí, byla odstraněna a zase nezaschla. Nejšetrněji a nejspolehlivěji je možno ji odstranit za použití výkonného vodního vysavače. Po čištění má povrch zůstat suchý.

Postavební úklid – čištění po dokončení stavby

Po dokončení kladenských prací je nutno vyčistit položenou plochu od znečištění po stavebních pracích a spárování cementovými hmotami. K odstranění těchto nečistot jsou vhodné čisticí prostředky s obsahem kyselin (pH < 6), tzv. odstraňovače cementových zbytků, doporučujeme použít **RAKO SYSTEM CL 802**. Při tomto úklidovém kroku je nutno dbát na doporučené ředění čisticího prostředku, aby nedošlo u tmavých a silně pigmentovaných spárovacích hmot k jejich narušení a zesvětlení. Pro obkládačky – ve skupině BIII – viz str. 358 – použijeme ředění 50–100 ml prostředku **RAKO SYSTEM CL 802** na 10 l vody. Pro hutné dlaždice a slinuté dlaždice – ve skupině BIb a BIa – viz str. 359 – můžeme použít ředění 100–200 ml prostředku CL 802 na 10 l vody. Plochu je vždy nutno předem důkladně namočit vodou a po čištění neutralizovat opět vodou!

Jsou-li na dlažbě skvrny od barvy, laku, silikonu nebo epoxidu, je nutné k jejich odstranění použít speciální čisticí prostředky.

Periodický úklid – běžný pravidelný úklid

Běžná denní údržba se provádí zametením, vysáváním nebo vytřením vlhkým hadrem nebo mopem za použití vhodného neutrálního čisticího prostředku (pH 6,0 až 8,0), zde doporučujeme použít **RAKO SYSTEM CL 803** pro všechny druhy keramických obkladových prvků v méně zatěžených prostorech (byty, RD, kanceláře) a v silně zatěžených prostorech (prodejny, haly, chodby, bytové domy...) použít **RAKO SYSTEM CL 801**.

Generální úklid – důkladné čištění, provádí se 1–2x za rok

Slouží k odstranění silného znečištění, které bylo naneseno během používání hutných dlaždic a slinutých dlaždic – ve skupině BIb a BIa – viz str. 359 – a které nebylo možné odstranit při běžném čištění. Nejčastěji se používají pro odstranění mastných zbytků na podlahách alkalické čisticí prostředky (pH > 8), doporučujeme **RAKO SYSTEM CL 810** a pro odstranění vápenatých usazenin z tvrdé vody kyselá čisticí prostředky (pH < 6), doporučujeme **RAKO SYSTEM CL 801**. Vzájemnou kombinací těchto prostředků dokážeme odstranit i značné znečištění dlažby.

K odstranění silného znečištění od mastných zbytků na obkládačkách ve skupině BIII – viz str. 358 – se použijí alkalické čisticí prostředky (pH > 8), doporučujeme **RAKO SYSTEM CL 810** v ředění doporučeném výrobcem. Pro odstranění vápenatých usazenin z tvrdé vody na obkládačkách ve skupině BIII – viz str. 358 – doporučujeme kyselá čisticí prostředky (pH < 6), např. **RAKO SYSTEM CL 801**. Před použitím kyselého čisticího prostředku povrch obkládaček navlhčíme a po aplikaci naředěného prostředku **RAKO SYSTEM CL 801** (40–100 ml na 10 l vody) opláchneme povrch obkládaček několikrát čistou vodou.

Pro údržbu obkládaček a dlaždic nesmí být použity v žádném případě čisticí prostředky obsahující kyselinu fluorovodíkovou, protože již po krátkodobém působení se keramické obklady masivně narušují a trvale poškozují!

Nesmí se používat nedoporučené čisticí prostředky, které na povrchu vytvoří film, který může snížit protiskluznost keramických dlaždic, narušit glazuru nebo může opticky změnit povrch, vytvořit šmouhy a zhoršovat čistitelnost.

Je důležité řídit se přesně pokyny výrobců čisticích prostředků na jejich použití a dávkování, protože špatné použití může keramický povrch, spáry a elastické těsnící materiály narušit, popř. poškodit.

Zvláštní čisticí postupy:

- **Dekorační prvky zdobené zlatými, platinovými a perleťovými povrchy** myjeme vodou s čisticím prostředkem **RAKO SYSTEM CL 803**. K jejich čištění se nesmí používat prostředky a nářadí s obsahem abrazivních částic nebo agresivních chemických látek.
- **Metallické povrchy**, např. série Defile (hnědá), jsou na povrchu opatřeny vrstvičkou s obsahem kovu a vyžadují zvýšenou péči při čištění. K odstranění zbytků spárovacích hmot a skvrn po nečistotách doporučujeme nejprve namočit spáry vodou, pak dlaždice odmastit naředěným čisticím **RAKO SYSTEM CL 810** (ředění 40–100 ml na 10 l vody), poté zneutralizovat vodou, následně vyčistit nečistoty prostředkem **RAKO SYSTEM CL 801** (40–100 ml na 10 l vody) a omýt čistou vodou. Kombinací obou čisticích prostředků lze dále střídat pro dokonalé vyčištění. Nedoporučujeme na metalické povrchy nanášet impregnační nátěry nebo neověřená čisticí prostředky.
- **Protiskluzné podlahy je třeba pravidelně čistit za použití doporučených přípravků** podle charakteru znečištění. Jakékoli nečistoty, písek, mastný povrch, zbytky sněhu a ledu výrazně snižují protiskluzné charakteristiky povrchu dlaždic. Na mastné plochy doporučujeme alkalický čisticí prostředek **RAKO SYSTEM CL 810** ve výše uvedené koncentraci. Před použitím kyselých nebo alkalických čisticích prostředků a po něm je nutné podlahy důkladně opláchnout velkým množstvím čisté vody. K čištění větší plochy jsou vhodné mycí stroje s šetrným mechanickým čištěním nebo s tlakovou vodou. K odstranění vody z povrchu protiskluzné dlažby, např. na ochozech bazénů, podlahách velkých kuchyní, je doporučováno speciální nářadí (např. gumové stěrky apod.). Údržbu hladkých i protiskluzných dlaždic usnadňuje impregnace prostředkem **RAKO SYSTEM CL 809**.
- **Impregnace dlažby prostředkem RAKO SYSTEM CL 809** usnadňuje její údržbu a snižuje spotřebu čisticích prostředků (nižší koncentrace). Vždy je nutno ji použít na leštěné slinuté neglazované dlaždice TAURUS ihned po položení a vyčištění, protože technologie leštění snižuje odolnost proti tvorbě skvrn. **Velmi tenká vrstva impregnačního nátěru RAKO SYSTEM CL 809 nemění barvu povrchu ani protiskluzné vlastnosti dlaždic, ale výrazně omezuje zanášení povrchu nečistotami.** Nanáší se ve dvou velmi tenkých vrstvách na pečlivě očištěné suché dlaždice. Pro běžnou údržbu takto ošetřených dlaždic postačuje čištění vodou s prostředkem **RAKO SYSTEM CL 803**, viz výše.

Kompletní přehled čisticích prostředků naleznete na www.rakosystem.cz, informace a poradenství poskytují informační linky: info@rako.cz, tel.: 800 303 333.



EN Maintenance and cleaning of ceramic wall and floor tiles

Regular and correct cleaning is an integral part of wall and floor tile care. Cleaning technique and products must be selected correctly depending on the soiling character, type of surface and cleaning method. The following types of cleaning of ceramic materials must be distinguished:

post-building-works cleaning – cleaning after the building works completion,

regular cleaning – routine periodic cleaning

heavy duty cleaning – carried out 1–2 times a year.

Depending on the size and type of the surface to be cleaned, the cleaning can be done either by hand using a brush, cloth, pad or mop or, for cleaning large surfaces, suitable rotating cleaning machines or vacuum cleaners or high-pressure cleaning machines can be used. High-pressure cleaning machines with a spraying injector are suitable for severely soiled and anti-slip surfaces. Irrespective of the cleaning technique selected, it is necessary to make sure that the released dirt dissolved during the cleaning process is removed and not allowed to dry again. The most gentle and reliable way of removing it is by using a high-performance water vacuum cleaner. After cleaning the surface should remain dry.

Post-building-works cleaning – Cleaning after building works completion

After tiles have been laid, the tiled surface must be cleaned of sediment and material left from building works and grouting. Detergents containing acids (pH < 6), so called cement residue removals are best for this purpose. We recommend **RAKO SYSTEM CL 802**. For this type of cleaning the detergent must be appropriately diluted to prevent dark and highly pigmented grouting materials from being disturbed and bleached. During this cleaning step, care must be taken to the recommended dilution of cleaners to avoid disturbing and lightening of dark and heavily pigmented grouting materials. For wall tiles - in group BIII - see page 358, 50–100 ml of the CL 802 can be diluted in 10 l of water. For compact and vitrified tiles - in group BIb and BIa - see page 359, 100–200 ml of the **RAKO SYSTEM CL 802** can be diluted in 10 l of water. First, the surface must always be thoroughly soaked with water and neutralised with water again after cleaning. Stains of paint, varnish, silicon or epoxy must be removed using special cleaning products.

Regular cleaning – routine periodic cleaning

Routine maintenance and cleaning of all types of tiles is performed by sweeping, vacuuming or wiping the surface with a wet cloth or mop, using a suitable neutral detergent (pH 6.0 to 8.0); here we recommend **RAKO SYSTEM CL 803**, for all types of wall and floor tiles at areas with a low amount of traffic (flats, family houses, offices) and with a high amount of traffic (shops, halls, hallways, apartment buildings...), we recommend **RAKO SYSTEM CL 801**.

Heavy duty cleaning – thorough cleaning, carried out 1–2 times a year

To remove heavily soiled surfaces created during the use of compact tiles and sintered tiles - in group BIb and BIa - see page 359 - which could not be removed by regular cleaning. Alkaline detergents (pH > 8) are most frequently used for removing greasy residues deposited on floor tiles are; we recommend **RAKO SYSTEM CL 810**. For removing lime sediments caused by water hardness acidic detergents (pH < 6), we recommend **RAKO SYSTEM CL 801**. In combination of these agents, we can remove also heavily soiled tiles.

To clean heavily soiled surfaces, containing fatty deposits on wall tiles in group BIII - see page 358 - alkaline cleaners (pH > 8) are used; we recommend using the **RAKO SYSTEM CL 810** and dilution recommended by the manufacturer. To remove lime scale deposits from hard water on wall tiles in group BIII - see page 358 - alkaline cleaners (pH < 6), such as the **RAKO SYSTEM CL 810**, are recommended. Before the use of acidic detergent, moisten the tile surface, and, after application of diluted **RAKO SYSTEM CL 801** (40–100 ml in 10 l of water), rinse the tile surface several times with clean water.

Do not use cleaning agents containing hydrofluoric acid for maintenance of wall and floor tiles, because ceramic tiles are massively distorted and permanently damaged after short-term exposure!

Never use non-recommended detergents which cause a film to develop on the tile surface which may reduce anti-slip properties of ceramic floor tiles, damage the glazing or optically change the surface, create smudges and impair cleaning ability.

Always closely follow instructions of the detergent manufacturer in respect of application and dosing, since incorrect application can disturb and damage the ceramic surface and sealing materials.

- **Decorative products with golden, platinum and mother-of-pearl surface finish**, must be cleaned with **RAKO SYSTEM CL 803** detergent. Never use detergents and tools containing abrasive particles or corrosive chemicals for cleaning these products.
- **Metallic surface finishes**, e.g. the Defile (brown) series have a thin surface layer containing metal, and these require extra care when being cleaned. To reduce residues of the grouting material and dirt stains, we recommend to first wet the grouting with water and then degrease the tiles with a diluted **RAKO SYSTEM CL 810** detergent (40–100 ml in 10 l of water), then neutralise them with water and clean them with a **RAKO SYSTEM CL 801** solution (40–100 ml in 10 l of water), and again rinse with clean water. The combination of the two detergents can then be alternated to achieve a perfect result. We do not recommend applying impregnation coating on metallic surfaces or using untested detergents.
- **Anti-slip floors must be cleaned regularly using recommended** detergents depending on the character of their soiling. Any dirt, sand, greasy deposits or remnants of snow and ice significantly reduce the anti-slip properties of the floor tile surface. For greasy patches we recommend **RAKO SYSTEM CL 810** alkali detergent in the above specified concentration. The floor must be thoroughly rinsed with plenty of clean water before and after the use of acidic and alkali detergents. For cleaning larger areas we recommended using cleaning machines, either with a gentle mechanical cleaning mechanism or with pressure water. For removing water from the surface of anti-slip floor tiles, e.g. on walkways around swimming pools or floors in large kitchens, we recommend special tools (e.g. a window cleaning blade). Applying the **RAKO SYSTEM CL 809** impregnation products makes the maintenance of both smooth and anti-slip floor tiles easier.
- **Floor tiles treated with the RAKO SYSTEM CL 809 impregnation product** are easier to maintain and require less detergent (lower concentration). It is always necessary to use it on polished, vitrified, unglazed tiles TAURUS immediately after laying and cleaning, because polishing technology reduces the resistance to staining. **The very thin layer of RAKO SYSTEM CL 809 impregnation product does not change changes the surface colour nor the floor tiles' anti-slip properties, and significantly reduces the amount of dirt accumulated on the tiles' surface.** The product is applied in two very thin coats on carefully cleaned and dry tiles. For regular maintenance of treated floor tiles a solution of the **RAKO SYSTEM CL 803** detergent with water – see above, will be sufficient.

A complete list of detergents can be found in www.rakosystem.eu, for information and advisory services contact our information e-mail: info@rako.cz.



PL Utrzymanie i czyszczenie płytek ceramicznych ściennych i podłogowych

Systematyczne i prawidłowe czyszczenie jest nieodłącznym elementem dbałości o płytki. Sposób czyszczenia i środki czyszczące trzeba dobierać odpowiednio do charakteru zanieczyszczenia, rodzaju powierzchni i metody czyszczenia. Podczas czyszczenia materiałów ceramicznych trzeba rozróżniać

sprzątanie po budowie - czyszczenie po dokończeniu budowy,

okresowe sprzątanie – regularne sprzątanie

sprzątanie generalne – przeprowadza się 1–2x na rok.

W zależności od wielkości i rodzaju czyszczonej powierzchni można wybrać czyszczenie ręczne szczotką, szmatą, padem, mopem lub w przypadku dużych powierzchni wskazane jest użycie tarczowych maszyn czyszczących i odkurzających lub wysokociśnieniowych maszyn czyszczących. Wysokociśnieniowe maszyny czyszczące z dyszą są wskazane na mocno zanieczyszczone i przeciwpoślizgowe powierzchnie. Niezależnie od wybranego rodzaju czyszczenia trzeba uważać na to, aby uwolniony brud, który podczas czyszczenia rozpuszcza się, został usunięty i nie zaschnął ponownie. Najdelikatniej i najłatwiej można go usunąć za pomocą silnego odkurzacza wodnego. Po czyszczeniu powierzchnia powinna zostać sucha.

Sprzątanie po budowie – Czyszczenie po ukończeniu budowy

Po ukończeniu układania trzeba wyczyścić wykończoną powierzchnię z zanieczyszczeń po pracach budowlanych i spoinowaniu masami cementowymi. Do usuwania tych zanieczyszczeń są wskazane środki czyszczące zawierające kwasy (pH < 6), tzw. usuwacze resztek cementowych, zalecamy użycie **RAKO SYSTEM CL 802**. Na tym etapie czyszczenia należy stosować zalecane stężenia środka czyszczącego, aby nie doszło do uszkodzenia i rozjaśnienia ciemnych, lub mocno pigmentowanych zapraw do spoinowania. Do płytek ściennych z grupy BIII – str. 358 – stosujemy rozcieńczenie 50–100 ml środka **RAKO SYSTEM CL 802** na 10 l wody. Do płytek podłogowych i gresów - grupa BIb i BIa - str. 359 – możemy stosować 100 – 200 ml środka **RAKO SYSTEM CL 802** na 10 l wody. Czyszczone powierzchnie zawsze należy wcześniej mocno nawilżyć, a po myciu ponownie zneutralizować wodą. Jeżeli na podłodze ceramicznej są plamy od farby, lakieru, silikonu lub epoksydu, do ich usunięcia trzeba użyć specjalnych środków czyszczących.

Sprzątanie okresowe – regularne mycie i czyszczenie

Codziennie mycie i czyszczenie realizuje się przez zamiatanie, odkurzanie lub wycieranie wilgotną szmatą lub mopem z użyciem odpowiedniego neutralnego środka czyszczącego (pH od 6,0 do 8,0), tu zalecamy użycie **RAKO SYSTEM CL 803**, dla wszystkich rodzajów okładzin ceramicznych w pomieszczeniach o mniejszym nasileniu ruchu (mieszkania, biura), zaś w silnie obciążonych pomieszczeniach (sklepy, hale, korytarze) zalecamy **RAKO SYSTEM CL 801**.

Sprzątanie generalne – Gruntowne czyszczenie, przeprowadza się 1–2x na rok

Stosuje się do usunięcia mocnych zabrudzeń, które powstało przez użytkowanie płytek podłogowych i gresów – z grupy BIb i BIa - str. 359 - i którego nie było można usunąć podczas bieżącego sprzątania. Najczęściej do usuwania tłustych resztek na podłogach używa się alkalicznych środków czyszczących (pH > 8), zalecamy **RAKO SYSTEM CL 810** a do usuwania osadów wapiennych z twardej wody kwaśnych środków czyszczących (pH < 6), zalecamy **RAKO SYSTEM CL 801**. Naprzemiennym stosowaniem tych dwu środków można oczyścić bardzo zabrudzone powierzchnie.

Do usuwania mocnych zabrudzeń, spowodowanych tłustymi resztkami, na płytkach ściennych z grupy BIII - str. 358 - stosuje się zasadowe środki czyszczące (pH > 8), proponujemy **RAKO SYSTEM CL 810** w stężeniu zalecanym przez producenta. Do usuwania osadów wapiennych po twardej wodzie na płytkach ściennych z grupy BIII - str. 358 – proponujemy kwaśne środki czyszczące (pH < 6), np. **RAKO SYSTEM CL 801**. Przed zastosowaniem kwaśnego środka czyszczącego, powierzchnię płytki zwilżamy, a po zastosowaniu rozcieńczonego **RAKO SYSTEM CL 801** (40–100 ml na 10 l wody) optukujemy kilkakrotnie czystą wodą.

Do pielęgnacji płytek ściennych i podłogowych nie mogą być, w żadnym przypadku, stosowane środki czyszczące zawierające kwas fluorowodorowy, który już po krótkim oddziaływaniu znacząco i nieodwracalnie uszkadza powierzchnię płytek.

Nie należy używać niezalecanych środków czyszczących, które na powierzchni tworzą film, który mogą obniżyć przeciwpoślizgowość płytek ceramicznych, naruszyć szkliwo, lub mogą optycznie zmienić powierzchnię, wytworzyć smugi i utrudniać czyszczenie.

Ważne jest kierowanie się dokładnie instrukcjami producentów środków czyszczących, dotyczącymi ich stosowania i dawkowania, ponieważ nieprawidłowe użycie może naruszyć lub uszkodzić powierzchnię ceramiczną, fugi i elastyczne materiały uszczelniające.

- **Elementy dekoracyjne zdobione złotymi, platynowymi i perłowymi powierzchniami** myjemy wodą ze środkiem czyszczącym **RAKO SYSTEM CL 803**. Do ich czyszczenia nie wolno używać środków i narzędzi zawierających ścierną cząstkę lub agresywne substancje chemiczne.
- **Powierzchnie metaliczne**, np. seria Defile (brązowa), posiadają na powierzchni warstwę zawierającą metal i wymagają szczególnej ostrożności podczas czyszczenia. Do usuwania resztek mas fugowych i plam po zanieczyszczeniach zalecamy najpierw namoczenie spoin wodą, następnie odtuszczenie płytek rozcieńczonym środkiem czyszczącym **RAKO SYSTEM CL 810** (rozcieńczenie 40–100 ml na 10 l wody), następnie zneutralizowanie wodą, następnie wyczyszczenie zanieczyszczeń środkiem **RAKO SYSTEM CL 801** (40–100 ml na 10 l wody) i umycie czystą wodą. Kombinacji obu tych środków czyszczących można używać do skutecznego czyszczenia. Nie zalecamy nanoszenia na metaliczne powierzchnie impregnatów lub niesprawdzonych środków czyszczących.
- **Podłogi przeciwpoślizgowe trzeba systematycznie czyścić za pomocą zalecanych** preparatów według charakteru zanieczyszczenia. Jakiegokolwiek zanieczyszczenia, piasek, tłusta powierzchnia, resztki śniegu i lodu wyraźnie pogarszają właściwości przeciwpoślizgowe powierzchni płytek. Na tłuste powierzchnie zalecamy alkaliczny środek czyszczący **RAKO SYSTEM CL 810** w podanym powyżej stężeniu. Przed i po użyciu kwaśnych lub alkalicznych środków czyszczących konieczne jest staranne optukanie podłogi dużą ilością czystej wody. Do czyszczenia większych powierzchni wskazane są odpowiednie maszyny myjące z delikatnym czyszczeniem mechanicznym lub wodą pod ciśnieniem. Do usuwania wody z powierzchni przeciwpoślizgowej, np. na obrzeżach basenów, podłogach dużych kuchni, zaleca się używanie specjalnych narzędzi (np. gumowe zgarniaczy, itp.). Utrzymanie gładkich i przeciwpoślizgowych płytek ułatwia impregnacja środkiem **RAKO SYSTEM CL 809**.

- **Impregnacja podłogi środkiem RAKO SYSTEM CL 809** ułatwia jej utrzymanie i obniża zużycie środków czyszczących (niższe stężenie). Zawsze trzeba go użyć na polerowane nieszkliwione płytki TAURUS. **Bardzo cienka warstwa powłoki impregnującej RAKO SYSTEM CL 809 nie zmienia koloru powierzchni ani właściwości przeciwpoślizgowych płytek, ale wyraźnie ogranicza zanieczyszczenie powierzchni.** Nanosi się w dwóch bardzo cienkich warstwach na starannie oczyszczoną suchą powierzchnię. Impregnację polerowanych płytek spiekanych trzeba zawsze przeprowadzić po ich potożeniu i wyczyszczeniu. Do utrzymania bieżącego w ten sposób chronionych płytek polerowanych wystarcza czyszczenie wodą ze środkiem **RAKO SYSTEM CL 803**, patrz powyżej.

Kompletny przegląd środków czyszczących można znaleźć na www.rakosystem.eu, informacje i rady można uzyskać na: info@rako.cz.



RUS Уход за керамической напольной плиткой и облицовочной плиткой

Регулярная и правильная чистка является неотъемлемой частью ухода за напольной и облицовочной плиткой. Порядок чистки и средства для чистки необходимо выбирать с учетом характера загрязнения, типа поверхности и метода чистки. При чистке керамических материалов необходимо различать:

строительную уборку, т.е. чистку после завершения строительных работ;

периодическую уборку – текущую регулярную уборку

генеральную уборку – выполняется 1–2 раза в год.

В зависимости от размера и типа поверхности можно воспользоваться щеткой, тряпкой, шваброй или mopом, для уборки больших помещений желательно воспользоваться дисковыми уборочными машинами или высоконапорными уборочными машинами. Высоконапорные уборочные машины с разбрызгивателями пригодны для сильно загрязненных поверхностей с противоскользящими свойствами. При всех способах чистки необходимо обращать внимание на то, чтобы грязь была своевременно удалена и не могла снова засохнуть. Наиболее надежным и бережным способом чистки плитки является чистка с помощью мощного водного пылесоса. После чистки поверхность должна быть сухой.

Строительная уборка – после завершения строительных работ

После завершения укладки плитки необходимо очистить поверхность плитки от загрязнений, возникших в ходе строительных работ и удалить остатки цементной затирки. Для удаления данных загрязнений пригодны чистящие средства, содержащие кислоты (pH < 6) – специальные средства для удаления остатков цемента. Поэтому рекомендуем воспользоваться средством **RAKO SYSTEM CL 802**. В ходе данного этапа уборки необходимо следить за тем, чтобы чистящее средство было разбавлено согласно рекомендациям производителя, для того, чтобы темные и сильнопигментированные расшивки не повреждались и не теряли цвет. Для настенной плитки – в группе BIII – см. стр. 358, норма расхода составляет 40–100 мл средства **RAKO SYSTEM CL 802** на 10 л воды. Для напольной плитки с плотным черепком и спекаемой напольной плитки – в группе BIb и BIa – см. стр. 359 – норма расхода составляет 100–200 мл средства **RAKO SYSTEM CL 802** на 10 л воды. Предварительно поверхность необходимо тщательно намочить водой, а после проведения очистки провести нейтрализацию водой!

Для устранения с плитки пятен от краски, лака, силикона или эпоксидной смолы необходимо воспользоваться специальными чистящими средствами.

Периодическая уборка – текущая регулярная уборка

Ежедневный уход и очистка могут проводиться путем заметания, уборки пылесосом или мокрой уборки тряпкой или mopом с применением подходящего нейтрального чистящего средства (pH 6,0 – 8,0). Для мокрой уборки рекомендуем воспользоваться средством **RAKO SYSTEM CL 803** для всех видов керамической плитки в помещениях с низкой нагрузкой (квартиры, коттеджи, офисы), в помещениях с сильной нагрузкой (магазины, цеха, коридоры и т.д.) следует воспользоваться средством **RAKO SYSTEM CL 801**.

Генеральная уборка – тщательная чистка, выполняется 1-2 раза в год

Служит для устранения сильного загрязнения напольной плитки с плотным черепком и спекаемой напольной плитки – в группе BIb и BIa – см. стр. 359 – которые нельзя удалить в ходе текущей чистки. При генеральной уборке для удаления жирных загрязнений наиболее часто применяются щелочные чистящие средства (pH > 8), рекомендуем воспользоваться средством **RAKO SYSTEM CL 810**. Для удаления известковых отложений, образующихся при воздействии жесткой воды, применяются кислые чистящие средства (pH < 6), рекомендуем воспользоваться средством **RAKO SYSTEM CL 801**. Сочетание данных средств позволяет очистить и чрезвычайно загрязненную напольную плитку. Для устранения сильных загрязнений (например, жирные пятна) на облицовочной плитке в группе BIII – см. стр. 358 – применяются щелочные чистящие средства (pH > 8), рекомендуем **RAKO SYSTEM CL 810**, средство разбавляется согласно рекомендациям производителя.

Для удаления известковых отложений, образующихся на настенной плитке под воздействием жесткой воды, в группе BIII – см. стр. 358 – рекомендуем кислые чистящие средства (pH < 6), например, **RAKO SYSTEM CL 801**. Перед использованием кислого чистящего средства поверхность настенной плитки следует увлажнить, а после нанесения разбавленного средства **RAKO SYSTEM CL 801** (40–100 мл на 10 л воды) поверхность настенной плитки следует несколько раз промыть чистой водой.

Для ухода за настенной и напольной плиткой запрещено применять чистящие средства, содержащие фтористоводородную кислоту, так как даже незначительное по продолжительности воздействие фтористоводородной кислоты существенно нарушает структуру керамических облицовочных элементов и приводит к их необратимому повреждению!

Не следует применять чистящие средства, применение которых не рекомендуется, образующих на поверхности плитки пленку, которая снижает противоскользкие характеристики керамической плитки, нарушает глазурь, изменяет внешний вид поверхности, образует подтеки и усложняет чистку.

Важно точно соблюдать инструкции производителей чистящих средств, что касается применения и дозировки чистящих средств, так как неправильное применение чистящих средств может привести к повреждению керамической поверхности, цементных швов и эластичных герметизирующих материалов.

- **Декоративные элементы, украшенные золотом, платиной и перламутром** необходимо мыть водой с чистящим средством **RAKO SYSTEM CL 803**. Запрещена чистка с применением средств и инструментов, содержащих абразивные частицы или агрессивные химические вещества.
- **Металлические поверхности**, например, серии Defile (коричневая плита), снабжены тонким слоем с содержанием металла и требуют особо осторожного ухода. Для удаления остатков затирочных масс и пятен рекомендуем сначала намочить швы водой, после чего обезжирить плитку разбавленным чистящим средством **RAKO SYSTEM CL 810** (40–100 мл на 10 л воды), затем нейтрализовать водой, вычистить чистящим средством **RAKO SYSTEM CL 801** (40–100 мл на 10 л воды) и смыть чистой водой. Сочетание вышеуказанных чистящих средств можно применять до момента полной очистки поверхности. На металлические поверхности не рекомендуем наносить пропиточные средства или какие-либо непроверенные чистящие средства.
- **Противоскользкие полы необходимо регулярно чистить с применением рекомендованных чистящих средств**, учитывая характер загрязнения. Любые загрязнения, песок, жирная поверхность, остатки снега и льда существенно уменьшают противоскользкие свойства напольной плитки. Для очистки жирных поверхностей рекомендуем воспользоваться щелочным чистящим средством **RAKO SYSTEM CL 810** в вышеуказанной концентрации. Перед применением и после применения кислых и щелочных чистящих средств необходимо помыть полы большим количеством чистой воды. Для чистки больших площадей желательно воспользоваться уборочными машинами с легкой механической очисткой или высоконапорными уборочными машинами. Для удаления воды с поверхности противоскользкой плитки, например: с дорожки у бассейна, пола больших кухонь и т.д. рекомендуется воспользоваться специальными приспособлениями (например, резиновый скребок). Уход за гладкой и противоскользкой напольной плиткой упрощает применение пропиточного средства **RAKO SYSTEM CL 809**.
- **Пропитка плитки средством RAKO SYSTEM CL 809** упрощает уход и уменьшает расход чистящих средств (более низкая концентрация). Обязательно применяется для полированной спеченной неглазурованной плитки серии TAURUS сразу же после укладки и очистки, так как технология полировки снижает стойкость плитки к образованию пятен. **Очень тонкий слой пропиточного средства RAKO SYSTEM CL 809 не изменяет цвет поверхности, не влияет на противоскользкие свойства плитки, но существенно снижает загрязнение поверхности.** Пропиточное средство наносится двумя очень тонкими слоями на тщательно очищенную, сухую плитку. Для текущего ухода полированной напольной плитки с нанесенной пропиткой достаточно применение чистой воды со средством **RAKO SYSTEM CL 803**, см. выше.

Полный обзор чистящих средств приведен на сайте www.rakosystem.eu. Получить информацию и проконсультироваться можно по справочному адресу и телефону: info@rako.cz.

Čistící postupy

При чистění standardních keramických povrchů je třeba dodržovat následující postupy.

Druh čištění	Postup	Čistící prostředek a dávkování
Postavební úklid – úklid volné špíny	Metení nebo vysávání	
Postavební úklid – úklid cementových zbytků, minerálních vápenatých a hořečnatých usazenin, cementového závoje, malířské hlínky, rzi	<ol style="list-style-type: none"> 1. Dlažbu a spáry předem dostatečně namočit vodou. 2. Nanést čisticí roztok, nechat působit 10 až 15 min a vyčistit mopem s krátkým mikrovláknem, padem, silonovým kartáčem nebo houbou 3. Odstranit rozpuštěnou špínu 4. Dlažbu vytřít 2x dostatkem vody 	Kyselý čisticí prostředek, např. RAKO SYSTEM CL 802 , dávkování: 50 až 100 ml na 10 l vody pro obkládačky skupiny BIII; 100–200 ml na 10 l vody pro dlaždice skupiny BIb a BIa
Odstranění tuků, olejů, vosků, kosmetiky a oděrek z bot	<ol style="list-style-type: none"> 1. Nanést čisticí roztok, nechat působit 10 až 15 min a vyčistit mopem s krátkým mikrovláknem, padem, silonovým kartáčem nebo houbou 2. Odstranit rozpuštěnou špínu 3. Dlažbu ještě jednou vytřít dostatkem vody 	Alkalický čisticí prostředek, např. RAKO SYSTEM CL 810 , dávkování: 40 až 100 ml na 10 l vody
Periodický úklid – odstranění normálního znečištění, jako je prach, lehce přilnavá špína, špína z ulice	Nanést čisticí roztok a vytřít mopem nebo hadrem	Neutrální čisticí prostředek, např. RAKO SYSTEM CL 803 , silně zatěžené prostory čistit RAKO SYSTEM CL 801 , dávkování: 20 až 100 ml na 10 l vody Koupelny, WC – RAKO SYSTEM CL 804 (přímý postřik)
Generální úklid – kyselé prostředí (minerální znečištění: zbytky cementu, vápna, vápeného mýdla, rzi, vodního kamene, urinů)	<ol style="list-style-type: none"> 1. Dlažbu předem namočit (spáry)! 2. Nanést čisticí roztok (na skvrny možné použít koncentrovaný roztok) a vyčistit mopem s mikrovláknem, padem nebo čisticím strojem 3. Rozpuštěnou špínu vysát 4. Dlažbu dobře znova umýt vodou 	RAKO SYSTEM CL 801 , dávkování: 40–100 ml na 10 l vody RAKO SYSTEM CL 804 – přímý postřik
Generální úklid – alkalické prostředí (znečištění tukem nebo olejem)	<ol style="list-style-type: none"> 1. Nanést čisticí roztok a vyčistit mopem s mikrovláknem, padem nebo čisticím strojem 2. Rozpuštěnou špínu vysát 3. Dlažbu dobře znova umýt vodou 	RAKO SYSTEM CL 810 , dávkování: 40–100 ml na 10 l vody



Cleaning procedures

When cleaning standard ceramic surface please follow these procedures.

Type of cleaning	Process	Cleaning agents and dilution
Post-construction cleaning – cleaning of loose dirt	Sweeping or vacuuming	
Post-construction cleaning – cleaning of cement residues, mineral, calcium and magnesium deposits, cement bloom, paint rock, rust	<ol style="list-style-type: none"> 1. Ceramic tiles and joints should be completely wet (use sufficient quantity of clean water) 2. Apply the cleaning solution, leave for 10 to 15 min. then clean with microfiber mop, pad or nylon brush or sponge 3. Remove dissolved dirt 4. Mop the tiles up twice with sufficient quantity of water 	Acid detergent, such as RAKO SYSTEM CL 802 , dosage: For wall tiles in group BIII, 50-100 ml for 10 l of water; for floor tiles in group Bib and Bla, 100-200 ml for 10 l of water
Removal of fats, oils, waxes, cosmetics and abrasions of from shoes	<ol style="list-style-type: none"> 1. Apply the cleaning solution, let act leave for 10 to 15 min and clean with microfiber mop, pad or nylon brush or sponge 2. Remove dissolved dirt 3. Wash the tiles thoroughly with water afterwards 	Alkaline cleaning agent eg RAKO SYSTEM CL 810 , Dilution: 40-100 ml per 10 liters of water
Regular cleaning - removal of normal soiling, such as dust, slightly sticky dirt, dirt from the street	Apply the cleaning solution, and clean with mop, pad, nylon brush or cloth	Neutral detergent eg RAKO SYSTEM CL 803 , RAKO SYSTEM CL 801 is recommended for areas with a high amount of traffic Dilution: 20-100 ml per 10 liters of water Bathrooms, WC - RAKO SYSTEM CL 804 (direct spraying)
General cleaning - acidic environment (mineral impurities: residues of cement, lime, calcium soaps, rust, scale, urines)	<ol style="list-style-type: none"> 1. First, soak the tiles (joints)! 2. Apply the cleaning solution (concentrated solution may be used on stains) and clean using a mop with microfibers, a pad, or a cleaning machine 3. Remove the dissolved dirt by suction 4. Wash the tiles again thoroughly with water 	RAKO SYSTEM CL 801 , dosage: 40-100 ml for 10 l of water RAKO SYSTEM CL 804 - by direct spraying
General cleaning - alkaline environment (contaminated with grease or oil)	<ol style="list-style-type: none"> 1. Apply the cleaning solution and clean using a mop with microfibers, a pad, or a cleaning machine 2. Remove the dissolved dirt by suction 3. Wash the tiles again thoroughly with water 	RAKO SYSTEM CL 810 , dosage: 40-100 ml for 10 l of water



CL 801 AKTIVNÍ ČIŠTĚNÍ PRO SLINUTÉ KERAMICKÉ OBKLADY

CL 801 je speciální čisticí prostředek na lehce a silně znečištěné slinuté neglazované a glazované dlaždice gres-porcellanato, např. typu TAURUS, KENTAUR a ostatní neglazované dlaždice. Účinnější složení čisticích látek, parfemace, nové zabarvení.

ACTIVE CLEANER FOR VITREOUS CERAMIC TILES

CL 801 is a special cleaner for slightly and heavily soiled vitrified non-glazed and glazed gres-porcellanato tiles, e.g. the TAURUS or KENTAUR type and other non-glazed tiles.



CL 802 PRO POSTAVEBNÍ ÚKLID A ODSTRANĚNÍ CEMENTOVÝCH A VÁPENNÝCH ZBYTKŮ

Koncentrovaný nepěňivý prostředek určený k použití na keramické a žulové povrchy. Je vhodný pro postavební úklid, kde dosahuje vynikajících výsledků hned po prvním použití. Účinně působí na cementové zbytky, hlínky po malování, cementové závoje, hořečnaté a minerální usazeniny - rez a vodní či močový kámen. Nepoužívat na nekyselínovzdorné materiály (mramor, travertin apod.). Vhodný i do potravinářských provozů.

FOR POST-BUILDING CLEANUP AND REMOVAL OF CEMENT AND LIME RESIDUES

A concentrated, non-foamy agent for ceramic and granite surfaces. It is suitable for post-building cleanup, where it achieves perfect results after the first application. It works well on cement residues, paint rock, cement stains, magnesium and mineral residues - rust and scale or urinary scale. Do not use on surfaces not resistant to acids (marble, travertine etc.).



CL 810 PRO ODSTRANĚNÍ MASTNOTY A OLEJŮ

Koncentrovaný nepěňivý prostředek určený k ředění a průmyslovému čištění veškerých tvrdých podlahových ploch odolných vodě a alkáliím, jako jsou PVC, linolea (včetně voskovaných), dlažby glazované i neglazované, žulové, mramorové i vápencové povrchy, teraso, cihelné a betonové povrchy vč. litých podlah, gumové podlahy, podlahy sportovních hal, lakované parkety i palubky. Prostředek je šetrný k ošetřovaným povrchům.

FOR REMOVAL OF GREASE AND OILS

A concentrated dilutable non-foaming agent used for industrial cleaning of all hard floor surfaces resistant to water and alkalis such as PVC, linoleums (including waxed), glazed and non-glazed tiles, granite, marble and lime surfaces, brick and concrete surfaces including poured floors, rubber floors, sports halls, varnished wooden parquets and floorboards. The cleaner is gentle to the treated surfaces.



CL 803 PRO DENNÍ ÚKLID

Prostředek určený k čištění a leštění povrchů v jednom kroku. Je určen zejména pro povrchy náchylné k poškození a zmatování jako jsou leštěné mramory, žuly a přírodní i umělé kameny. Obsahuje velmi jemné a neutrální tenzidy, které účinně odstraní i odolné nečistoty. Možno použít i na plasty. Zvýšený lesk, vylepšené hloubkové čištění (deep cleaning), ochrana povrchu (surface protection), nová parfemace.

FOR DAILY CLEANUP

An agent used for cleaning and polishing surfaces in a single step. It is convenient for surfaces sensitive to damage or matting such as polished marble, granite and natural as well as artificial stone. It contains very fine neutral tensides, which efficiently remove even resistant dirt. It can also be used for plastics.



CL 804 PRO VYSOKÝ LESK KOUPELNY

Prostředek CL 804 je zárukou perfektně vyleštěné koupelny! Je vhodný k mytí obkladů, umyvadel, van, sprchových koutů, baterií, vnějších částí toaletních mís atd. Přípravek snadno odstraňuje skvrny a nánosy vodního kamene, obsahuje lesk, který zpomaluje znečištění povrchu a dlouhodobě zlepšuje vzhled leštěných a chromovaných povrchů. Není vhodný na povrchy, které nemají odolnost proti kyselinám.

FOR A HIGH GLOSS IN THE BATHROOM

The CL 804 cleaner is a guarantee of a perfectly polished bathroom! Suitable for cleaning of tiling, basins, tubs, showers, faucets, outer parts of toilet bowls, etc. The agent easily removes stains and scale sediments and contains a glossy substance that slows pollution of the surface and improves the appearance of polished and chromed surfaces for a long time. It is not suitable for surfaces that are not resistant to acids.



CL 809 IMPREGNACE PRO KERAMICKÉ OBKLADY A DLAŽBY

Prostředek CL 809 je určený k impregnaci neporézních materiálů. Vytváří na povrchu ochrannou vrstvu, která zabraňuje pronikání vody, olejů a omezuje usazování nečistot. Povrch se lépe čistí, zajistí dlouhodobé zlepšení vzhledu, usnadňuje odstraňování graffiti.

Pro keramické leštěné dlažby, pracovní desky kuchyňských linek, desky stolů, parapety, římsy krbů atd. **Impregnace snižuje protiskluznost dlažby.** Před nanášením impregnace musí být plochy zbaveny veškerých nečistot!

IMPREGNATION FOR CERAMIC WALL AND FLOOR TILES

CL 809 is used for the impregnation of non-porous materials. It forms a protective layer on the surface, which prevents the penetration of water or oils and reduces deposits of dirt. It makes cleaning of the surface and removing graffiti easier and the appearance is improved for a long time. For polished ceramic floor tiles, kitchen worktops, tabletops, sills, mantelpieces, etc. **The impregnant does not reduce slip-resistant properties of the tiles.** All surfaces must be cleared of all impurities before application!

Doporučené postupy a přehled všech výrobků stavební chemie RAKO SYSTEM naleznete v katalogu produktů RAKO SYSTEM 2018 nebo na www.rakosystem.cz

Recommended procedures and list of all products of RAKO SYSTEM building chemistry can be found in the RAKO SYSTEM 2018 product catalogue or at www.rakosystem.eu

CZ Environmentální prohlášení o produktu podle ISO 14 025 a EN 15 804

Prohlášení výrobce o environmentálních parametrech odvozených z LCA (životní cyklus výrobku):

Produktový systém a hranice systému – viz tabulka č.1

Hranic systému studie životního cyklu výrobku je **pouze informační modul A1 – A3 „Výrobní fáze“** v souladu s normou EN 15804:2012.

Tabulka 1

Informace o hranicích produktového systému – informačních modulech (X = zahrnuto, MND = modul není deklarován)																	
Výrobní fáze			Fáze výstavby		Fáze užívání							Fáze konce životního cyklu				Doplňující informace nad rámec životního cyklu	
Dodávání nerostných surovin	Doprava	Výroba	Doprava na stavbu	Proces výstavby/instalace	Užívání	Údržba	Oprava	Výměna	Rekonstrukce	Provozní spotřeba energie	Provozní spotřeba vody	Demolice/dekonstrukce	Doprava	Zpracování odpadu	Odstraňování	Přínosy a náklady za hranici systému. Potenciál opětovného použití, využití a recyklace	D
A1	A2	A3	A4	A5	B1	B2	B3	B4	B5	B6	B7	C1	C2	C3	C4	D	
X	X	X	MND	MND	MND	MND	MND	MND	MND	MND	MND	MND	MND	MND	MND	MND	MND

Parametry popisující environmentální dopady-viz tabulka č.2

Informace o environmentálních dopadech jsou vyjádřeny v parametrech kategorií dopadu LCIA (hodnocení dopadu životního cyklu) a jsou vztaženy na funkční jednotku (FJ) – 1m² plochy produktu.

Tabulka 2

Výsledek LCA – Parametry popisující environmentální dopady (FJ = 1 m ² produktu)		
Parametr	Jednotka	A1-A3
Potenciál globálního oteplování (GWP)	kg CO ₂ ekv.	10,0
Potenciál úbytku stratosferické ozonové vrstvy (ODP)	kg CFC 11 ekv.	1,05 E-6
Potenciál acidifikace půdy a vody, (AP)	kg SO ₂ ekv.	0,0215
Potenciál eutrofizace (EP)	kg (PO ₄) ₃ - ekv.	0,0182
Potenciál tvorby přízemního ozonu (POCP)	kg Ethene ekv.	0,00122
Potenciál úbytku surovin (ADP-prvky) pro nefosilní zdroje	kg Sb ekv.	0,0781
Potenciál úbytku surovin (ADP-fosilní paliva) pro fosilní zdroje	MJ, výhřevnost	171,5

Parametry popisující spotřebu zdrojů – viz tabulka č.3

Tyto environmentální parametry popisují spotřebu obnovitelných a neobnovitelných materiálových zdrojů, obnovitelné a neobnovitelné primární energie a vody.

Tabulka 3

Výsledek LCA – Parametry popisující spotřebu zdrojů		
Parametr	Jednotka	A1-A3
Spotřeba obnovitelné primární energie s výjimkou zdrojů energie využitých jako suroviny	MJ	8,1
Spotřeba obnovitelných zdrojů primární energie využitých jako suroviny	MJ	0
Celková spotřeba obnovitelných zdrojů primární energie (primární energie a zdroje primární energie využitě jako suroviny)	MJ	8,1
Spotřeba neobnovitelné primární energie s výjimkou zdrojů energie využitých jako suroviny	MJ	165
Spotřeba neobnovitelných zdrojů primární energie využitých jako suroviny	MJ	0
Celková spotřeba neobnovitelných zdrojů primární energie (primární energie a zdroje primární energie využitě jako suroviny)	MJ	165
Spotřeba druhotných surovin	MJ	0
Spotřeba obnovitelných druhotných paliv	MJ	0
Spotřeba neobnovitelných druhotných paliv	MJ	0
Čistá spotřeba pitné vody	m ³	0,0580

Součástí firemní strategie společnosti LASSELSBERGER, s.r.o. je výroba ekologicky šetrných výrobků, která splňuje platné národní i mezinárodní normy a využívá systému řízení šetrného k životnímu prostředí. Vydáním environmentálního prohlášení o produktu podle ISO 14 025 se společnost zavazuje plnit požadavky na ochranu životního prostředí.

Podrobnější informace naleznete na našich webových stránkách.

EN Environmental Product Declaration in accordance with ISO 14 025 and EN 15 804

Manufacturer's declaration of environmental parameters derived from LCA (product life cycle):

Product system and system boundaries – see Table 1

The system boundary of the product life cycle study is only **information Module A1 - A3 "Production Phase"** in accordance with EN 15804:2012.

Table 1

Information about the product system boundaries – information modules (X = included, MND = module is not included)																		
Production phase			Construction phase		Usage phase							Life cycle phase				Additional information beyond the life cycle		
Delivery of minerals	Transport	Production	Transport on site	Construction /installation process	Usage	Maintenance	Repair	Replacement	Reconstruction	Operational energy consumption	Operational water consumption	Demolition /deconstruction	Transport	Waste treatment	Removal	Benefits and costs beyond the system boundary. Potential of re-use, recovery and recycling	D	
A1	A2	A3	A4	A5	B1	B2	B3	B4	B5	B6	B7	C1	C2	C3	C4	D		
X	X	X	MND	MND	MND	MND	MND	MND	MND	MND	MND	MND	MND	MND	MND	MND	MND	

Parameters describing environmental impacts - see Table 2

Information about environmental impacts are expressed in impact category parameters LCIA (life cycle impact assessment), and they are related to the functional unit (FJ) – 1m² of the product.

Table 2

LCA result – Parameters describing environmental impacts (FJ = 1 m ² of the product)		
Parameter	Unit	A1-A3
Global warming potential (GWP)	kg CO ₂ eqv.	10,0
Ozone depletion potential (ODP)	kg CFC 11 eqv.	1,05 E-6
Soil and water acidification potential (AP)	kg SO ₂ eqv.	0,0215
Eutrophication potential (EP)	kg (PO ₄) ₃ - eqv.	0,0182
Photochemical ozone creation potential (POCP)	kg Ethane eqv.	0,00122
Abiotic depletion potential (ADP - elements) for non-fossil resources	kg Sb eqv.	0,0781
Abiotic depletion potential (ADP - fossil fuels) for fossil resources	MJ, calorific value	171,5

Parameters describing resource consumption - see Table 3

These environmental parameters describe the consumption of renewable and non-renewable material resources, renewable and non-renewable primary energies, and water.

Table 3

LCA result – Parameters describing resource consumption		
Parameter	Unit	A1-A3
Consumption of renewable primary energy, with the exception of energy resources utilized as raw materials	MJ	8,1
Consumption of renewable primary energy resources utilized as raw materials	MJ	0
Total consumption of renewable primary energy resources (primary energy resources utilized as raw materials)	MJ	8,1
Consumption of non-renewable primary energy, with the exception of energy resources utilized as raw materials	MJ	165
Consumption of non-renewable primary energy resources utilized as raw materials	MJ	0
Total consumption of non-renewable primary energy resources (primary energy and primary energy resources utilized as raw materials)	MJ	165
Consumption of secondary raw materials	MJ	0
Consumption of renewable secondary fuels	MJ	0
Consumption of non-renewable secondary fuels	MJ	0
Net consumption of drinking water	m ³	0,0580

A part of the LASSELSBERGER, s.r.o. company strategy is producing ecologically friendly products in compliance with current national and international standards while employing an environmentally friendly management system. By issuing the environmental product declaration (EPD) according to ISO 14025, the company commits itself to meeting the requirements for protecting the environment.

For more information visit our website.



CZ Prostory zatížené krátkodobou, ale opakovanou vlhkostí mohou neúměrně zatěžovat podkladní konstrukce a v případě pronikající vlhkosti poskytují ideální prostředí pro tvorbu mikroorganismů. Z těchto důvodů je nutné zabránit pronikání vody do podkladů. Doporučujeme proto dodržovat následující postupy a skladby materiálů:

PRACOVNÍ POSTUP – DETAILNÍ POPIS

Příprava: Podklad musí být pevný, vyzrálý, zbavený nečistot a nerovností. V případě nedostatků použijte pro plošné vyrovnání stěn i podlah materiál LE 21. Pro rychlou lokální opravu pak MO 35 QUICK.

Penetrování savých podkladů: Všechny savé podklady penetrujeme nátěrem PE 201. V případě velmi savých materiálů použijeme PE 202 v příslušném ředění (cca 1:3-5). Spotřeba 0,15–0,25 l/m² aplikované tekutiny.

Izolování – utěsnění všech prostorů zatěžovaných vodou: Napenetrované plochy izolujeme nátěrem SE 1 ve dvou vrstvách s technologickou přestávkou 4–6 hodin. Pochůzlost a možnost lepení cca po 10–12 hodinách. Celková spotřeba cca 1,2–1,6 kg/m². Pro překlenutí přechodů, dilatací a zpevnění vnitřních rohů vkládáme do izolační vrstvy bandáž SE 5. Nutno dokonale celoplošně vlepít do SE 1. Uvažovaná spotřeba cca 0,25 kg/bm.

Montáž keramických obkladů a dlažeb na izolační vrstvu: Pro montáž obkladů a dlažeb je nutno použít modifikované lepicí tmely. Pro standardní formáty našeho bytového keramického programu používáme cementové lepidlo AD 510 PLUS třídy C1TE. Pro zmenšené formáty a mozaiky lze použít bílé cementové lepidlo AD 509 PLUS třídy C1TE. Spotřeba tmelů se pohybuje od 2 do 4 kg/m².

Spárování keramického pláště: Při spárování používáme flexibilní hmotu GF BIO, popřípadě GF DRY, obě kategorie CG2WA. Při použití těchto spárovacích hmot je díky speciálním přísadám zvýšena vodoodpudivost, GF BIO navíc poskytuje ochranu proti tvorbě plísní a výkvětů. Tímto je výrazně zvýšena hygiena celého povrchu! Spotřeba cca 0,3–0,8 kg/m² dle formátu obkladových prvků.

Těsnění pružných spár a prostupů trvale pružným tmelem: Pro umožnění dilatačního pohybu ve spáře je nutné použití trvale pružného tmelu SI. Barevná škála pokrývá všechny barvy hmoty řady GF DRY. Při aplikaci hmoty SI je vhodné použití pokladního provazce PES. Zamezí nežádoucímu přilnutí ke dnu spáry a vymezí přesný tvar silikonové výplně. Vydátost kartuše 310 ml je cca 6–12 bm dle velikosti spáry.

Úklid

Pro odstranění cementových povlaků použijte čisticí prostředek CL 802. Po důkladném vyčištění povrchu doporučujeme provést celoplošnou impregnaci povrchu přípravkem CL 809.

Údržba

Pro běžnou údržbu použijte čisticí prostředek CL 804 (obklady, baterie, sanita...) a CL 803 na podlahy.

EN Short-term, but regular, humidity may apply excessive loads to the base structures and, for penetrating humidity, may create ideal conditions for micro-organic growth. Therefore, water leakage to the base must be prevented. To this end, we recommend applying the following procedures and types of construction materials.

WORK PROCEDURE – DETAILED DESCRIPTION

Preparation: The base must be rigid, cured, and free of any impurities and uneven spots. In the event of any problems in these areas, use LE 21 for levelling of the walls and floors. For quick localized repairs, use MO 35 QUICK.

Priming absorbent bases: All absorbent bases must be primed with PE 201. For extremely absorbent materials, use PE 202 at the required dilution ratio (approx. 1:3-5). Approx. 0.15–0.25 l/m² of the product is needed.

Insulation – sealing all water-loaded rooms: Insulate the primed surfaces with SE 1 in two layers, taking a 4–6 hour break between applications. The tiles will be ready for loading and gluing after approx. 10–12 hours. Approx. 1.2–1.6 kg/m² is needed. For bridging any transitions and joints, and for reinforcing the internal corners, SE 5 gauze is inserted into the insulating layer. The gauze must be attached across the entire surface of the SE 1. Approx. 0.25 kg/bm is needed for full contact.

Installation of ceramic wall and floor tiles on the insulation layer: modified adhesive sealants must be used for wall and floor tile installations. For the standard formats within our housing ceramic programme, we use C1TE grade AD 510 PLUS cement adhesive. For smaller formats and mosaics, C1TE grade white AD 509 PLUS cement adhesive may be used. Between 2 and 4 kg/m² of sealant is needed.

Ceramic shell jointing: For jointing, we use flexible GF BIO material, or CG2 WA grade GF DRY. Thanks to special additives, use of these jointing materials increases the water repellent qualities of the system; GF BIO moreover offers protection against mould and efflorescence.

TYPOVÁ SKLADBA



This markedly increases the sanitary properties of the entire surface! Between approx. 0.3 and 0.8 kg/m² is typically needed, depending on the format size of the tiles.

Sealing of flexible joints and passageways with permanently elastic sealant: Permanently elastic SI sealant must be used to allow expansion movement within the joint. The colour range covers all colours of the GE DRY product line. If SI silicone is applied, it is recommended that a PES polyethylene separator be used. It will prevent undesired adhesion to the bottom of the joint and define the exact shape of the silicone filler. The spreading rate of the 310 ml cartridge is approx. 6–12 mb, depending on the size of the joint.

Cleaning

Use the CL 802 cleaning agent to remove any cement deposits. Once the surface is thoroughly cleaned, we recommend that full-surface priming be applied with CL 809.

Maintenance

Use the CL 804 (tiles, faucets, sanitary installations, etc.) and CL 803 (floors) cleaning agents for regular cleaning.

CZ Systém TICHÁ DLAŽBA jednoduchým způsobem řeší pokládku keramické dlažby na pružné nestandardní podklady (např. dřevěné konstrukce stropů s dřevotřískovými podlahami, podlahy z parket aj.). Separací SDI panel vložený mezi keramickou dlažbu a podklad eliminuje možnost vzniku smykového napětí při nadměrných deformacích v podlahových konstrukcích. Tento panel svojí strukturou dokáže zajistit i akustický útlum a lze jej použít jako kročejovou izolaci.

PRACOVNÍ POSTUP – DETAILNÍ POPIS

Příprava: U vytvoření podkladů z OSB desek doporučujeme montáž dvou vrstev o síle 18 a 15 mm, které pokládáme na vazbu spár. Obě vrstvy pak dokonale spojíme prošroubováním. Betonové a anhydritové podklady musí vykazovat dostatečnou pevnost a soudržnost. Odchyłka rovinnosti podkladu nesmí přesáhnout 2 mm na 2 m lati. V případě nedostatků je třeba použít samonivelační vyrovnávací hmoty LE 20 nebo LE 30.

Penetrace podkladů: Na pružné a deformovatelné podklady (Cetris, OSB) aplikujeme kontaktní můstek pomocí nátěru CP 203 s obsahem plniva. Předpokládaná spotřeba kontaktního můstku je 0,25–0,4 kg/m². Savé povrchy podlahových konstrukcí (beton, anhydrit) je nutno penetrovat nátěrem PE 202 v příslušném ředění (cca 1:3-5). Spotřeba cca 0,15 l/m² aplikované tekutiny.

Montáž izolačního obvodového pásu: Po obvodě plochy aplikujeme na stěnu samolepicí dilatační pás DSAT šíře 25 mm. Ten oddělí aplikovanou skladbu od obvodových stěn a zároveň přeruší eventuální akustické mosty mezi dlažbou a stěnou.

Montáž zvukové izolačního panelu: Montáž panelu SDI provedeme za pomoci cementového lepidla AD 590 třídy C2TES1, které svým speciálním složením zajišťuje dokonalý kontakt s materiálem panelu a zkracuje technologické pauzy. Používáme zubovou stěrku 3–4 mm se spotřebou cca 2,1 kg/m². Spáry mezi deskami doporučujeme přelepit úzkou krycí papírovou páskou, která zaručí správnou funkčnost desek a zamezí vzniku akustického mostu při lepení dlažby.

Izolování – utěsnění všech prostorů zatěžovaných vodou: Izolování provádíme na zabudované SDI panely, viz systémové řešení koupelny.

Montáž keramické dlažby: Pro montáž keramické dlažby použijeme opět cementové lepidlo AD 590 třídy C2FTES1. Použitá stěrka 8 mm, spotřeba pro lepení dlažby činí cca 4,2 kg/m².

Spárování plochy dlažby: Po vytvrzení lepidla celoplošně spárujeme cementovou hmotou GF DRY třídy CG2WA dodávanou v plném barevném spektru 24 barev. V případě použití na výrazně deformující se podklady doporučujeme použít rychle tuhnoucí spárovací hmotu GFS třídy CG2WAS1, se zvýšenou schopností příčné deformace. Spotřeba cca 0,4–0,8 kg/m².

Tmelení dilatačních spár: V obvodové spáře k soklům a v dilatacích je nutné použití trvale pružného silikonového tmelu SI dodávaného v barevné škále hmoty GF DRY. Při aplikaci hmoty SI je vhodné použití pokladního provazce PES. Zamezí nežádoucímu přilnutí ke dnu spáry a vymezí přesný tvar silikonu. Vydátost kartuše 310 ml je cca 6–12 bm dle velikosti spáry.

Úklid

Pro odstranění cementových zbytků použijte čisticí prostředek CL 802. Po důkladném vyčištění povrchu doporučujeme provést celoplošnou impregnaci povrchu přípravkem CL 809.

Údržba

Pro běžnou údržbu použijte čisticí prostředek CL 803 v kombinaci s CL 802 (vodní kámen) a CL 810 (mastnoty).

Akustický útlum při skladbě s SDI panelem závisí na celkové skladbě stropní konstrukce. Ze zkušeností vyplývá, že dosažený akustický útlum se pohybuje kolem 18 dB.

EN In order to minimise the dimensional requirements for the composition of impact sound insulation, we offer a very effective solution using an SDI sound insulation panel. During laying, the slab is placed right under the ceramic tiles, with the resulting composition providing the defined sound transmission attenuation. Moreover, the panel eliminates the risk of shear stress under excessive deformations in the floor structure, thus allowing the laying of tiles on entirely non-standard bases (such as wooden ceiling structures, particleboard flooring, etc.).

WORK PROCEDURE – DETAILED DESCRIPTION

Preparation: The base must exhibit adequate strength and consistency before laying. The base flatness deviation must not exceed 2 mm per 2 m of the bar. In the event of any shortcomings identified in this area, use LE 20 or LE 30 self-levelling material. Where the laying is undertaken on top of an impact sound insulation layer with a higher thickness, the base must be strengthened with the installation of two OSB board layers. The 18 mm- and 15 mm-thick boards are laid on the joint connections, perfectly fixing the two layers to one another with screws.

Base priming: The absorbent flooring structure surfaces must be primed with PE 202 at the required dilution ratio (approx. 1:3-5). Approximately 0.15 l/m² of liquid is needed. A contact bridge must be applied to deformable and non-absorbent bases (Cetris, OSB) using the CP 203 filler-bearing product. Approx. 0.25–0.4 kg/m² is needed for the contact bridge.

Installation of a peripheral insulation strip: A self-adhesive DSAT separating strip, 25 mm wide, must be installed around the circumference of the insulated surface. The strip will disrupt any sound bridges formed between the tiles/wall.

Installation of a sound insulation panel: The SDI sound insulation panel is installed using C2FTE S1 grade AD 590 cement adhesive, which, with its special composition, ensures perfect contact with the panel material and shortens the application intervals. We use a Swedish smoother, 3–4 mm long, which gives a consumption figure of approx. 2.1 kg/m². We recommend that the joints between the boards be resealed with a narrow paper tape preventing any sound bridges from developing when the tiles are attached.

Insulation – sealing all water-loaded spots: The insulation is applied to the integrated SDI panels, see bathroom system solutions.

Installation of ceramic tiles: Again, C2FTE S1 grade AD 590 cement adhesive is used for installation of the ceramic tiles. An 8 mm smoother is used and approx. 4.2 kg/m² is needed for attaching the tiles.

TYPOVÁ SKLADBA



Jointing the tile surface: Once the adhesive has fully cured, CG2 WA grade GD DRY cement adhesive (available in the full colour spectrum of 24 colours) is used for full-area jointing. Where used on massively deforming bases, we recommend using the quick drying CG2 WA S1 grade GFS product, with increased transversal deformation properties. Approx. 0.4–0.8 kg/m² is needed.

Sealing of expansion joints: In the peripheral joint at the base interface, and in expansion joints, it becomes necessary to use the permanently elastic SI silicone sealant, which is supplied in the colour range of the GF DRY material. If SI silicone is applied, it is recommended that a PES polyethylene separator be used. It will prevent undesired adhesion to the bottom of the joint and define the exact shape of the silicone. The spreading rate of the 310 ml cartridge is approx. 6–12 bm, depending on the size of the joint.

Cleaning

Once the cement residue is removed, use the CL 802 cleaning agent. Once the surface is thoroughly cleaned, we recommend that full-surface priming be applied with CL 809.

Maintenance

For regular maintenance, use the CL 803 cleaning agent combined with CL 802 (scale) and CL 810 (grease).



CZ Při obkládání suchých montovaných konstrukcí je třeba dbát na jejich pružnost a přizpůsobení materiálů (v našem případě keramického obkladu) k vyrovnání pohybů konstrukce. Proto dbáme na kvalitní přípravu podkladu a využíváme flexibilních materiálů k jejich montáži.

PRACOVNÍ POSTUP – DETAILNÍ POPIS

Příprava: Podklad musí být pevný, zbavený nečistot a nerovností. Penetrování podkladu: U sádrokartonových desek je třeba ošetřit jejich nasákavost neředěným nátěrem PE 201. V případě velmi savých materiálů použijeme PE 202 v příslušném ředění (cca 1:3-5). Spotřeba 0,15–0,25 l/m² aplikované tekutiny.

Izolování – utěsnění všech prostorů zatěžených vodou: viz systémové řešení koupelny.

Montáž keramických obkladů a dlažeb na izolační vrstvu: Pro montáž obkladů a dlažeb je nutno použít modifikované lepicí tmely. Pro standardní formáty našeho bytového keramického programu používáme cementové lepidlo AD 510 PLUS třídy C1TE nebo plně flexibilní lepidlo AD 520, AD 530. Pro zmenšené formáty a mozaiky lze použít bílé cementové lepidlo AD 509 PLUS třídy C1TE nebo plně flexibilní lepidlo AD 550. Spotřeba lepidel se pohybuje od 2 do 4 kg/m².

Spárování keramického pláště: Při spárování používáme flexibilní hmotu GF DRY, popřípadě GF BIO, obě kategorie CG2WA. Při použití těchto spárovacích hmot je díky speciálním přísadám zvýšena vodo-odpudivost, GF BIO navíc poskytuje ochranu proti tvorbě plísní a výkvětů. Tímto je výrazně zvýšena hygiena celého povrchu! Spotřeba cca 0,3–0,8 kg/ m² dle formátu obkladových prvků.

Těsnění pružných spár a prostupů trvale pružným tmelem: Pro umožnění dilatačního pohybu ve spáře je nutné použití trvale pružného tmelu SI. Barevná škála pokrývá všechny barvy hmoty řady GF. Při aplikaci hmoty SI je vhodné použití pokladního provazce PES. Zamezí nežádoucímu přilnutí ke dnu spáry a vymezí přesný tvar silikonové výplně. Vydátnost kartuše 310 ml je cca 6–12 bm dle velikosti spáry.

Úklid

Pro odstranění cementových povlaků použijte čisticí prostředek CL 802. Po důkladném vyčištění povrchu doporučujeme provést celoplošnou impregnaci povrchu přípravkem CL 809.

Údržba

Pro běžnou údržbu použijte čisticí prostředek CL 803 nebo CL 804.

EN While applying tiles to dry assembled structures, caution must be exercised while dealing with their flexibility and material adaptability (in this case, ceramic tiles) in order to balance any movement within the structure. Therefore, we concentrate on conditioning the base and using flexible installation materials.

WORK PROCEDURE – DETAILED DESCRIPTION

Preparation: The base must be rigid, cured, and free of any impurities and uneven spots.

Base priming: For plasterboard panels, their absorbency must be treated with a full strength PE 201 product. For extremely absorbent materials, use PE 202 at the required diluted ratio (approx. 1:3-5). Approx. 0.15-0.25 l/m² of the product is needed.

Insulation – sealing all water-loaded rooms: See the bathroom system solutions.

Installation of ceramic wall and floor tiles on an insulation layer: modified adhesive sealants must be used for wall and floor tile installations. For standard formats within our housing ceramic programme, we use C1TE grade AD 510 PLUS cement adhesive, or fully flexible AD 520, AD 530 adhesive. For reduced formats and mosaics, white C1TE grade AD 509 PLUS cement adhesive, or fully flexible AD 550 adhesive, may be used. Between 2 to 4 kg/m² of adhesive is needed.

Ceramic shell jointing: For jointing, we use CG2 WA grade GF BIO or GF DRY flexible material. Thanks to special additives, use of these jointing materials increase the water repellent qualities of the system; GF BIO moreover offers protection against mould and efflorescence. This markedly increases the sanitary properties of the entire surface! Between approx. 0.3 and 0.8 kg/m² of material is needed, depending on the format size of the tiles.

Sealing of flexible joints and passageways with permanently elastic sealant: Permanently elastic SI sealant must be used to allow expansion movement within the joint. The colour spectrum covers all colours available in the GF series. If SI material is applied, it is recommended that PES polyethylene separators are used. They will prevent undesired adhesion to the bottom of the joint and define the exact shape of the silicone filler. The spreading rate of the 310 ml cartridge is approx. 6–12 bm, depending on the size of the joint.

Cleaning

In order to remove any cement deposits, use the CL 802 cleaning agent. Once the surface is thoroughly cleaned, we recommend that full-surface priming be applied with CL 809.

Maintenance

For regular maintenance, use the CL 803 or 804 cleaning agent.

TYPOVÁ SKLADBA



		STO č. 030 - 049916	
		keramické tvarovky (ceramic special pieces)	
Technické vlastnosti Technical characteristics Parametry techniczne Технические параметры	Norma Norm Norma Стандарт	Požadavek normy EN 14411:2016 (max.) Standard requirements EN 14411:2016 (max.) Wymagania normy EN 14411:2016 (maks.) Параметры стандарта EN 14411:2016 (макс.)	Dosažovaná hodnota LB (max.) Parameters LB (max.) Parametry LB (maks.) Достижимые параметры LB (макс.)
Rozměry / Sizes Wymiary / Размер	ISO 10545-2	Délka a šířka / Length and width Długość i szerokość / Длина и ширина ±2,0% Tloušťka / Thickness / Grubość / Толщина ±10%	±2,0% ±10%
Nasákavost / Water absorption Nasiakliwość / Влагопоглощение	ISO 10545-3		E < 0,5%
Jakost povrchu Surface quality Jakość powierzchni Качество поверхности	ISO 10545-2	Min. 95% kusů bez viditelných vad povrchu Min. 95% of the tiles without visible defects Min. 95% sztuk bez widocznych wad Min. 95% шт. без видимых поверхностных дефектов	Min. 95% kusů bez viditelných vad povrchu Min. 95% of the tiles without visible defects Min. 95% sztuk bez widocznych wad Min. 95% шт. без видимых поверхностных дефектов
Pevnost v ohybu Bending strength Wytrzymałość na zginanie Прочность при изгибе	ISO 10545-4	Tloušťka > 7,5mm min. 28 N/mm ² Thickness / Grubość / Толщина	> 7,5mm min. 28 N/mm ²
Lomové zatížení Breaking strength / Siła łamiąca Сила нагрузки на изломе	ISO 10545-4	Tloušťka > 7,5mm min. 1300 N Thickness / Grubość / Толщина	> 7,5mm min. 1300 N
Odolnost proti změnám teploty / Thermal shock resistance Odpornosť na szok termiczny Устойчивость к изменению температурного режима	ISO 10545-9	Nepožaduje se / Not required Nie wymaga się / Не требуется	Odolné / Resistant Odporne / Стойкие
Odolnost proti vlivu mrazu Frost resistance Mrozoodpornost / Морозоустойчивость	ISO 10545-12	Požaduje se / Required Wymaga się / Требуется	Dokonale mrazuvzdorné / Fully frost resistant Dokonałemu mrozoodporne / Полностью морозоустойчивые
Odolnost proti vzniku vlasových trhlin Crazing resistance for glazed tiles / Odpornosť na pęknięcia włoskowate Устойчивость к образованию волосных трещин	ISO 10545-11	Požaduje se / Required Wymaga się / Требуется	Odolné / Resistant Odporne / Стойкие
Protiskluznost - koeficient tření Slip resistance - coefficient of friction Przeciwślizgowość Устойчивость к изнашиванию - коэффициент трения	CEN/TS 16 165 DIN 51130 DIN 51097 ČSN 725191	Hodnotu a odpovídající zkušební postup určí výrobce Manufacturer to state value and test method used Wartość i metodę badania ustala producent Величину и метод испытания определит производитель	Vybrané druhy / Selected types Wybrane rodzaje Группа определенных видов C
Odolnost proti hlubokému opotřebení Deep abrasion resistance Odpornosť na wgłębne ścieranie Устойчивость к глубинному истиранию	ISO 10545-6	Nepožaduje se / Not required Nie wymaga się / Не требуется	max. 275 mm ²
Tvrdost povrchu podle Mohse Surface hardness according to Mohs scale Twardość powierzchniowa według skali Mohsa Твердость поверхности по шкале Мооса	ČSN EN 101	Třídou určí výrobce Manufacturer to state classification Klasę określa producent Классификация определяется производителем	min. st. 5
Koef. délk. tepl. roztažnosti (20-100 °C) / Coefficient of linear thermal expansion (20-100 °C) / Współczynnik cieplnej rozszerzalności liniowej (20-100 °C) / Коэффициент линейного температурного расширения (20-100 °C)	ISO 10545-8	Nepožaduje se / Not required Nie wymaga się / Не требуется	max. 9 x 10 ⁻⁴ °C
Odolnost proti chem. používaným v domácnosti Resistance to various chemicals used in household Odpornosť na chemikalia domového užitku Устойчивость к воздействию бытовой химии	ISO 10545-13	Min. B Min. B Min. B Мин. B	Min. A Min. A Min. A Мин. A
Odolnost proti kys. a luhům o nízké koncentraci Resistance to low concentrations of acids and alkalis Odpornosť na slabé steženia kwasów i zasad Устойчивость к воздействию кислот и щелочей низкой концентрации	ISO 10545-13	Třídou určí výrobce Manufacturer to state classification Klasę określa producent Классификация определяется производителем	Min. tř. B Min. cl. B Min. kl. B Мин. кл. B
Odolnost proti kys. a luhům o vysoké koncentraci Resistance to high concentrations of acids and alkalis Odpornosť na mocne steženia kwasów i zasad Устойчивость к воздействию кислот и щелочей высокой концентрации	ISO 10545-13	Nepožaduje se / Not required Nie wymaga się / Не требуется	Min. tř. B Min. cl. B Min. kl. B Мин. кл. B
Odolnost proti tvorbě skvrn / Resistance to staining Odpornosť na plamienie / Устойчивость к образованию пятен	ISO 10545-14	Min. tř. 3 / Min. cl. 3 Min. kl. 3 / Мин. кл. 3	Min. tř. 3 / Min. cl. 3 Min. kl. 3 / Мин. кл. 3
Obsah olova a kadmia / Lead and cadmium release Uwalnianie ołowiu i kadmu / Содержание свинца и кадмия	ISO 10545-15	Nepožaduje se / Not required Nie wymaga się / Не требуется	Pb < 0,8 mg/dm ² Cd < 0,07 mg/dm ²

Podrobnější informace jsou uvedeny v Technickém katalogu / Detailed data is in Technical Catalogue / Szczegółowe informacje można uzyskać w Technicznym katalogu / Подробная информация приведена в Техническом каталоге

		EN 14411:2016, annex L BIII GL – Katalogové číslo (Catalogue number): Wxxxxxx obkládačky (wall tiles)				EN 14411:2016, annex H Bib GL – Katalogové číslo (Catalogue number): Gxxxxxx hutné dlaždice (compact floor tiles)				EN 14411:2016, annex G Bla GL, UGL – Katalogové číslo (Catalogue number): Dxxxxxx, Txxxxxx slinuté dlaždice (fully vitrified floor tiles)																	
Technické vlastnosti Technical characteristics Parametry techniczne Технические параметры		Norma Norm Norma Стандарт		Požadavek normy EN 14411:2016, příloha L BIII GL (max. hodnota) Standard requirements EN 14411:2016, annex L BIII GL (max. value) Wymagania normy EN 14411:2016, załącznik L BIII GL (maks. wartość) Параметры стандарта EN 14411:2016, прил. L BIII GL (макс. значение)				Dosahovaná hodnota LB (max.) Parameters LB (max.) Parametry LB (maks.) Достижимые параметры LB (макс.)				Požadavek normy EN 14411:2016, příloha H Bib GL (max. hodnota) Standard requirements EN 14411:2016 annex H Bib GL (max. value) Wymagania normy EN 14411:2016 załącznik H Bib GL (maks. wartość) Параметры стандарта EN 14411:2016 прил. H Bib GL (макс. значение)				Dosahovaná hodnota LB (max.) Parameters LB (max.) Parametry LB (maks.) Достижимые параметры LB (макс.)				Požadavek normy EN 14411:2016 příloha G Bla GL, UGL (max. hodnota) Standard requirements EN 14411:2016 annex G Bla GL, UGL (max. value) Wymagania normy EN 14411:2016 załącznik G Bla GL, UGL (maks. wartość) Параметры стандарта EN 14411:2016 прил. G Bla GL, UGL (макс. значение)				Dosahovaná hodnota LB (max.) Parameters LB (max.) Parametry LB (maks.) Достижимые параметры LB (макс.)			
				Standardní Standard		Rektifikované Rectified						Standardní Standard		Rektifikované Rectified		Leštěné Polished											
		max		max		max						max		max		max											
	Délka a šířka / Length and width Długość i szerokość / Длина и ширина	±0,5%	±2,0mm	±0,3%	±1,8mm	±0,2%	±1,2mm	±0,6%	±2,0mm	±0,4%	±1,25mm	±0,6%	±2,0mm	±0,4%	±1,5mm	±0,2%	±1,2mm	±0,2%	±1,2mm								
	Tloušťka / Thickness / Grubość / Толщина	±10%	±0,5mm	±5%	±0,5mm	±5%	±0,5mm	±5%	±0,5mm	±5%	±0,5mm	±5%	±0,5mm	±0,5%	±0,5mm	±5%	±0,5mm	±5%	±0,5mm								
	Přímost lícnicí hran / Linearity Krzywizna boków / Прямолинейность лиц/граней	±0,3%	±1,5mm	±0,2%	±1,2mm	±0,1%	±0,9mm	±0,5%	±1,5mm	±0,25%	±0,8mm	±0,5%	±1,5mm	±0,25%	±1,5mm	±0,1%	±0,6mm	±0,1%	±0,6mm								
	Pravouhlost / Rectangularity Prostokátnost / Прямоугольность	±0,5%	±2,0mm	±0,3%	±1,3mm	±0,2%	±1,0mm	±0,5%	±2,0mm	±0,3%	±1,0mm	±0,5%	±2,0mm	±0,3%	±1,8mm	±0,25%	±2,0mm	±0,2%	±1,2mm								
	Rovinnost lícnicí ploch ve středech a hranách/rohu Surface flatness in the middle of the flat/edge/angles Płaskość powierzchni krzywizna środka/boków/wyrzuczenie Прямолінейність лиц, поверхності в центрі поверхності/грані/по углам	+0,5% -0,3%	+2,0mm -1,5mm	+0,3% -0,15%	+1,0mm -0,7mm	+0,2% -0,1%	+1,5mm -0,7mm	±0,5%	±2,0mm	±0,25%	±0,8mm	±0,5%	±2,0mm	±0,25%	±1,2mm	±0,25%	±1,5mm	±0,2%	±0,6mm								
	Nasákavost / Water absorbtion Nasiąkliwość / Влагопоглищення	E > 10%		E 10-20 %		0,5% < E < 3,0% Jednotlivě 3,3%, Individually 3,3%		E < 2,5 %		UGL: E < 0,5% jednotlivě max. 0,6% individually max. 0,6% GL: E < 0,5% jednotlivě max. 0,6% individually max. 0,6%		UGL: E < 0,1% jednotlivě max. 0,2% individually max. 0,2% GL: E < 0,5% jednotlivě max. 0,6% individually max. 0,6%															
	Jakost povrchu Surface quality Jakość powierzchni Качество поверхности	ISO 10545-2	Min. 95% kusů bez viditelných vad povrchu Min. 95% of the tiles without visible defects Min. 95% sztuk bez widocznych wad Мін. 95% шт. без видимих поверхневих дефектів	Min. 95% kusů bez viditelných vad povrchu Min. 95% of the tiles without visible defects Min. 95% sztuk bez widocznych wad Мін. 95% шт. без видимих поверхневих дефектів	Min. 95% kusů bez viditelných vad povrchu Min. 95% of the tiles without visible defects Min. 95% sztuk bez widocznych wad Мін. 95% шт. без видимих поверхневих дефектів	Min. 95% kusů bez viditelných vad povrchu Min. 95% of the tiles without visible defects Min. 95% sztuk bez widocznych wad Мін. 95% шт. без видимих поверхневих дефектів	Min. 95% kusů bez viditelných vad povrchu Min. 95% of the tiles without visible defects Min. 95% sztuk bez widocznych wad Мін. 95% шт. без видимих поверхневих дефектів	Min. 95% kusů bez viditelných vad povrchu Min. 95% of the tiles without visible defects Min. 95% sztuk bez widocznych wad Мін. 95% шт. без видимих поверхневих дефектів	Min. 95% kusů bez viditelných vad povrchu Min. 95% of the tiles without visible defects Min. 95% sztuk bez widocznych wad Мін. 95% шт. без видимих поверхневих дефектів	Min. 95% kusů bez viditelných vad povrchu Min. 95% of the tiles without visible defects Min. 95% sztuk bez widocznych wad Мін. 95% шт. без видимих поверхневих дефектів	Min. 95% kusů bez viditelných vad povrchu Min. 95% of the tiles without visible defects Min. 95% sztuk bez widocznych wad Мін. 95% шт. без видимих поверхневих дефектів	Min. 95% kusů bez viditelných vad povrchu Min. 95% of the tiles without visible defects Min. 95% sztuk bez widocznych wad Мін. 95% шт. без видимих поверхневих дефектів	Min. 95% kusů bez viditelných vad povrchu Min. 95% of the tiles without visible defects Min. 95% sztuk bez widocznych wad Мін. 95% шт. без видимих поверхневих дефектів	Min. 95% kusů bez viditelných vad povrchu Min. 95% of the tiles without visible defects Min. 95% sztuk bez widocznych wad Мін. 95% шт. без видимих поверхневих дефектів	Min. 95% kusů bez viditelných vad povrchu Min. 95% of the tiles without visible defects Min. 95% sztuk bez widocznych wad Мін. 95% шт. без видимих поверхневих дефектів	Min. 95% kusů bez viditelných vad povrchu Min. 95% of the tiles without visible defects Min. 95% sztuk bez widocznych wad Мін. 95% шт. без видимих поверхневих дефектів	Min. 95% kusů bez viditelných vad povrchu Min. 95% of the tiles without visible defects Min. 95% sztuk bez widocznych wad Мін. 95% шт. без видимих поверхневих дефектів	Min. 95% kusů bez viditelných vad povrchu Min. 95% of the tiles without visible defects Min. 95% sztuk bez widocznych wad Мін. 95% шт. без видимих поверхневих дефектів	Min. 95% kusů bez viditelných vad povrchu Min. 95% of the tiles without visible defects Min. 95% sztuk bez widocznych wad Мін. 95% шт. без видимих поверхневих дефектів								
	Pevnost ohybu Bending strength Wytrzymałość na zginanie Прочность при изгибе	ISO 10545-4	Tloušťka > 7,5 mm min. 15 N/mm ² , Tloušťka < 7,5 mm min. 12 N/mm ² Thickness / Grubość / Толщина	> 7,5 mm min. 15 N/mm ² < 7,5 mm min. 12 N/mm ²	Min. 30 N/mm ² . Jednotlivě min. 27 N/mm ² Min. 30 N/mm ² . Individual min. 27 N/mm ² Min. 30 N/mm ² . Pojedynczo 27 N/mm ² Мін. 30 N/mm ² . Oddzielne види min. 27 N/mm ²	Min. 35 N/mm ² . Jednotlivě min. 32 N/mm ² Min. 35 N/mm ² . Individual min. 32 N/mm ² Min. 35 N/mm ² . Pojedynczo 32 N/mm ² Мін. 35 N/mm ² . Oddzielne види min. 32 N/mm ²	Min. 35 N/mm ² . Jednotlivě min. 32 N/mm ² Min. 35 N/mm ² . Individual min. 32 N/mm ² Min. 35 N/mm ² . Pojedynczo 32 N/mm ² Мін. 35 N/mm ² . Oddzielne види min. 32 N/mm ²	Min. 40 N/mm ² . Jednotlivě min. 32 N/mm ² Min. 40 N/mm ² . Individual min. 32 N/mm ² Min. 40 N/mm ² . Pojedynczo 32 N/mm ² Мін. 40 N/mm ² . Oddzielne види min. 32 N/mm ²	Min. 40 N/mm ² . Jednotlivě min. 32 N/mm ² Min. 40 N/mm ² . Individual min. 32 N/mm ² Min. 40 N/mm ² . Pojedynczo 32 N/mm ² Мін. 40 N/mm ² . Oddzielne види min. 32 N/mm ²	Min. 40 N/mm ² . Jednotlivě min. 32 N/mm ² Min. 40 N/mm ² . Individual min. 32 N/mm ² Min. 40 N/mm ² . Pojedynczo 32 N/mm ² Мін. 40 N/mm ² . Oddzielne види min. 32 N/mm ²	Min. 40 N/mm ² . Jednotlivě min. 32 N/mm ² Min. 40 N/mm ² . Individual min. 32 N/mm ² Min. 40 N/mm ² . Pojedynczo 32 N/mm ² Мін. 40 N/mm ² . Oddzielne види min. 32 N/mm ²	Min. 40 N/mm ² . Jednotlivě min. 32 N/mm ² Min. 40 N/mm ² . Individual min. 32 N/mm ² Min. 40 N/mm ² . Pojedynczo 32 N/mm ² Мін. 40 N/mm ² . Oddzielne види min. 32 N/mm ²	Min. 40 N/mm ² . Jednotlivě min. 32 N/mm ² Min. 40 N/mm ² . Individual min. 32 N/mm ² Min. 40 N/mm ² . Pojedynczo 32 N/mm ² Мін. 40 N/mm ² . Oddzielne види min. 32 N/mm ²	Min. 40 N/mm ² . Jednotlivě min. 32 N/mm ² Min. 40 N/mm ² . Individual min. 32 N/mm ² Min. 40 N/mm ² . Pojedynczo 32 N/mm ² Мін. 40 N/mm ² . Oddzielne види min. 32 N/mm ²	Min. 40 N/mm ² . Jednotlivě min. 32 N/mm ² Min. 40 N/mm ² . Individual min. 32 N/mm ² Min. 40 N/mm ² . Pojedynczo 32 N/mm ² Мін. 40 N/mm ² . Oddzielne види min. 32 N/mm ²	Min. 40 N/mm ² . Jednotlivě min. 32 N/mm ² Min. 40 N/mm ² . Individual min. 32 N/mm ² Min. 40 N/mm ² . Pojedynczo 32 N/mm ² Мін. 40 N/mm ² . Oddzielne види min. 32 N/mm ²	Min. 40 N/mm ² . Jednotlivě min. 32 N/mm ² Min. 40 N/mm ² . Individual min. 32 N/mm ² Min. 40 N/mm ² . Pojedynczo 32 N/mm ² Мін. 40 N/mm ² . Oddzielne види min. 32 N/mm ²	Min. 40 N/mm ² . Jednotlivě min. 32 N/mm ² Min. 40 N/mm ² . Individual min. 32 N/mm ² Min. 40 N/mm ² . Pojedynczo 32 N/mm ² Мін. 40 N/mm ² . Oddzielne види min. 32 N/mm ²	Min. 40 N/mm ² . Jednotlivě min. 32 N/mm ² Min. 40 N/mm ² . Individual min. 32 N/mm ² Min. 40 N/mm ² . Pojedynczo 32 N/mm ² Мін. 40 N/mm ² . Oddzielne види min. 32 N/mm ²								
	Lomové zatížení Breaking strength / Siła łamiąca Siła naładowania na izłomie	ISO 10545-4	Tloušťka > 7,5 mm min. 600 N, Tloušťka < 7,5 mm min. 200 N Thickness / Grubość / Толщина	> 7,5 mm min. 600 N < 7,5 mm min. 200 N	Tloušťka > 7,5 mm min. 1100 N, Tloušťka < 7,5 mm min. 700 N Thickness / Grubość / Толщина	Tloušťka > 7,5 mm min. 1300 N, Tloušťka < 7,5 mm min. 900 N Thickness / Grubość / Толщина	Tloušťka > 7,5 mm min. 1300 N, Tloušťka < 7,5 mm min. 700 N Thickness / Grubość / Толщина	Tloušťka > 7,5 mm min. 1500 N, Tloušťka < 7,5 mm min. 900 N Thickness / Grubość / Толщина	Tloušťka > 7,5 mm min. 1500 N, Tloušťka < 7,5 mm min. 900 N Thickness / Grubość / Толщина	Tloušťka > 7,5 mm min. 1500 N, Tloušťka < 7,5 mm min. 900 N Thickness / Grubość / Толщина	Tloušťka > 7,5 mm min. 1500 N, Tloušťka < 7,5 mm min. 900 N Thickness / Grubość / Толщина	Tloušťka > 7,5 mm min. 1500 N, Tloušťka < 7,5 mm min. 900 N Thickness / Grubość / Толщина	Tloušťka > 7,5 mm min. 1500 N, Tloušťka < 7,5 mm min. 900 N Thickness / Grubość / Толщина	Tloušťka > 7,5 mm min. 1500 N, Tloušťka < 7,5 mm min. 900 N Thickness / Grubość / Толщина	Tloušťka > 7,5 mm min. 1500 N, Tloušťka < 7,5 mm min. 900 N Thickness / Grubość / Толщина	Tloušťka > 7,5 mm min. 1500 N, Tloušťka < 7,5 mm min. 900 N Thickness / Grubość / Толщина	Tloušťka > 7,5 mm min. 1500 N, Tloušťka < 7,5 mm min. 900 N Thickness / Grubość / Толщина	Tloušťka > 7,5 mm min. 1500 N, Tloušťka < 7,5 mm min. 900 N Thickness / Grubość / Толщина	Tloušťka > 7,5 mm min. 1500 N, Tloušťka < 7,5 mm min. 900 N Thickness / Grubość / Толщина								
	Odolnost proti změnám teploty / Thermal shock resistance Odporność na szok termiczny Устойчивость к изменению температурного режима	ISO 10545-9	Nepožaduje se / Not required Nie wymaga się / Не требуется	Odolné / Resistant Odporne / Стойкие	Nepožaduje se / Not required Nie wymaga się / Не требуется	Odolné / Resistant Odporne / Стойкие	Nepožaduje se / Not required Nie wymaga się / Не требуется	Odolné / Resistant Odporne / Стойкие	Nepožaduje se / Not required Nie wymaga się / Не требуется	Odolné / Resistant Odporne / Стойкие	Nepožaduje se / Not required Nie wymaga się / Не требуется	Odolné / Resistant Odporne / Стойкие	Nepožaduje se / Not required Nie wymaga się / Не требуется	Odolné / Resistant Odporne / Стойкие	Nepožaduje se / Not required Nie wymaga się / Не требуется	Odolné / Resistant Odporne / Стойкие	Nepožaduje se / Not required Nie wymaga się / Не требуется	Odolné / Resistant Odporne / Стойкие	Nepožaduje se / Not required Nie wymaga się / Не требуется								
	Odolnost proti vlivu mrazu Frost resistance Mrozoodpornosć / Морозостойчивость	ISO 10545-12	Nepožaduje se / Not required Nie wymaga się / Не требуется	Nemrazuzodorné / Not frost resistant Brak mrozoodporności / Не морозостойчивы	Požaduje se / Required Wymaga się / Требуется	Mrazuzodorné / Frost resistant Mrozoodporna / Морозостойчивые Полностью	Požaduje se / Required Wymaga się / Требуется	Dokonale mrazuzodorné / Fully frost resistant Dokonalnie mrozoodporna Полностью морозостойчивые	Požaduje se / Required Wymaga się / Требуется	Dokonale mrazuzodorné / Fully frost resistant Dokonalnie mrozoodporna Полностью морозостойчивые	Požaduje se / Required Wymaga się / Требуется	Dokonale mrazuzodorné / Fully frost resistant Dokonalnie mrozoodporna Полностью морозостойчивые	Požaduje se / Required Wymaga się / Требуется	Dokonale mrazuzodorné / Fully frost resistant Dokonalnie mrozoodporna Полностью морозостойчивые	Požaduje se / Required Wymaga się / Требуется	Dokonale mrazuzodorné / Fully frost resistant Dokonalnie mrozoodporna Полностью морозостойчивые	Požaduje se / Required Wymaga się / Требуется	Dokonale mrazuzodorné / Fully frost resistant Dokonalnie mrozoodporna Полностью морозостойчивые	Požaduje se / Required Wymaga się / Требуется								
	Odolnost proti vzniku vlasových trhlin Crazing resistance for glazed tiles / Odporność na pęknięcia włoskowate Устойчивость к образованию волосных трещин	ISO 10545-11	Požaduje se / Required Wymaga się / Требуется	Odolné / Resistant Odporne / Стойкие	Požaduje se / Required Wymaga się / Требуется	Odolné / Resistant Odporne / Стойкие	Požaduje se / Required Wymaga się / Требуется	Odolné / Resistant Odporne / Стойкие	Požaduje se / Required Wymaga się / Требуется	Odolné / Resistant Odporne / Стойкие	Požaduje se / Required Wymaga się / Требуется	Odolné / Resistant Odporne / Стойкие	Požaduje se / Required Wymaga się / Требуется	Odolné / Resistant Odporne / Стойкие	Požaduje se / Required Wymaga się / Требуется	Odolné / Resistant Odporne / Стойкие	Požaduje se / Required Wymaga się / Требуется	Odolné / Resistant Odporne / Стойкие	Požaduje se / Required Wymaga się / Требуется								
	Protiskluznost - koeficient tření / Slip resistance - coefficient of friction Przeciwślizgowość Устойчивость к изнашиванию - коэффициент трения	CEN/TS 16 165 DIN 51130 DIN 51097 CSN 725191	Nepožaduje se / Not required Nie wymaga się / Не требуется	Nepožaduje se / Not required Nie wymaga się / Не требуется	Hodnotu a odpovídající zkušební postup určí výrobce Manufacturer to state value and test method used Wartości i metode badania ustala producent Величину и метод испытания определяет производитель	μ > 0,3 Vybrané druhy / Selected types Wybrane rodzaje Группа определенных видов R9 - R13, A - C, μ > 0,5	Hodnotu a odpovídající zkušební postup určí výrobce Manufacturer to state value and test method used Wartości i metode badania ustala producent Величину и метод испытания определяет производитель	μ > 0,3 Vybrané druhy / Selected types Wybrane rodzaje Группа определенных видов R9 - R13, A - C, μ > 0,5	Hodnotu a odpovídající zkušební postup určí výrobce Manufacturer to state value and test method used Wartości i metode badania ustala producent Величину и метод испытания определяет производитель	μ > 0,3 Vybrané druhy / Selected types Wybrane rodzaje Группа определенных видов R9 - R13, A - C, μ > 0,5	Hodnotu a odpovídající zkušební postup určí výrobce Manufacturer to state value and test method used Wartości i metode badania ustala producent Величину и метод испытания определяет производитель	μ > 0,3 Vybrané druhy / Selected types Wybrane rodzaje Группа определенных видов R9 - R13, A - C, μ > 0,5	Hodnotu a odpovídající zkušební postup určí výrobce Manufacturer to state value and test method used Wartości i metode badania ustala producent Величину и метод испытания определяет производитель	μ > 0,3 Vybrané druhy / Selected types Wybrane rodzaje Группа определенных видов R9 - R13, A - C, μ > 0,5	Hodnotu a odpovídající zkušební postup určí výrobce Manufacturer to state value and test method used Wartości i metode badania ustala producent Величину и метод испытания определяет производитель	μ > 0,3 Vybrané druhy / Selected types Wybrane rodzaje Группа определенных видов R9 - R13, A - C, μ > 0,5	Hodnotu a odpovídající zkušební postup určí výrobce Manufacturer to state value and test method used Wartości i metode badania ustala producent Величину и метод испытания определяет производитель	μ > 0,3 Vybrané druhy / Selected types Wybrane rodzaje Группа определенных видов R9 - R13, A - C, μ > 0,5	Hodnotu a odpovídající zkušební postup určí výrobce Manufacturer to state value and test method used Wartości i metode badania ustala producent Величину и метод испытания определяет производитель	μ > 0,3 Vybrané druhy / Selected types Wybrane rodzaje Группа определенных видов R9 - R13, A - C, μ > 0,5							
	Odolnost proti hloubkovému opotřebení Deep abrasion resistance Odporność na wgłębne ścieranie / Устойчивость к глубинному истиранию	ISO 10545-6	Nepožaduje se / Not required Nie wymaga się / Не требуется	Nepožaduje se / Not required Nie wymaga się / Не требуется	Nepožaduje se / Not required Nie wymaga się / Не требуется	Nepožaduje se / Not required Nie wymaga się / Не требуется	Nepožaduje se / Not required Nie wymaga się / Не требуется	Glazované - Glazed Nepožaduje se / Not required Nie wymaga się / Не требуется	Neglazované - Unglazed Max. 175 mm ³ Max. 175 mm ³ Maks. 175 mm ³ Макс. 175 mm ³	Glazované - Glazed Nepožaduje se / Not required Nie wymaga się / Не требуется	Neglazované - Unglazed Max. 135 mm ³ Max. 135 mm ³ Maks. 135 mm ³ Макс. 135 mm ³	Glazované - Glazed Nepožaduje se / Not required Nie wymaga się / Не требуется	Neglazované - Unglazed Max. 135 mm ³ Max. 135 mm ³ Maks. 135 mm ³ Макс. 135 mm ³	Glazované - Glazed Nepožaduje se / Not required Nie wymaga się / Не требуется	Neglazované - Unglazed Max. 135 mm ³ Max. 135 mm ³ Maks. 135 mm ³ Макс. 135 mm ³	Glazované - Glazed Nepožaduje se / Not required Nie wymaga się / Не требуется	Neglazované - Unglazed Max. 135 mm ³ Max. 135 mm ³ Maks. 135 mm ³ Макс. 135 mm ³	Glazované - Glazed Nepožaduje se / Not required Nie wymaga się / Не требуется	Neglazované - Unglazed Max. 135 mm ³ Max. 135 mm ³ Maks. 135 mm ³ Макс. 135 mm ³								
	Odolnost proti povrchovému opotřebení Abrasion resistance Odporność na ścieranie powierzchni Устойчивость к изнашиванию поверхности	ISO 10545-7	Nepožaduje se / Not required Nie wymaga się / Не требуется	Nepožaduje se / Not required Nie wymaga się / Не требуется	Třídou určí výrobce (třída PEI 1-5) Manufacturer to state classification (cl. PEI 1-5) Klasę ustala producent (kl. PEI 1-5) Классификация определяется производителем (кл. PEI 1-5)	Dle deklarace v katalogu As shown in catalogue	Třídou určí výrobce Manufacturer to state classification Klasę ustala producent Классификация определяется производителем	Dle deklarace v katalogu As shown in catalogue	Třídou určí výrobce Manufacturer to state classification Klasę ustala producent Классификация определяется производителем	Dle deklarace v katalogu As shown in catalogue	Třídou určí výrobce Manufacturer to state classification Klasę ustala producent Классификация определяется производителем	Dle deklarace v katalogu As shown in catalogue	Třídou určí výrobce Manufacturer to state classification Klasę ustala producent Классификация определяется производителем	Dle deklarace v katalogu As shown in catalogue	Třídou určí výrobce Manufacturer to state classification Klasę ustala producent Классификация определяется производителем	Dle deklarace v katalogu As shown in catalogue	Třídou určí výrobce Manufacturer to state classification Klasę ustala producent Классификация определяется производителем	Dle deklarace v katalogu As shown in catalogue	Třídou určí výrobce Manufacturer to state classification Klasę ustala producent Классификация определяется производителем								
	Koef. dělk. tepl. roztažnosti (20-100 °C) / Coefficient of linear thermal expansion (20-100 °C) / Współczynnik cieplnej rozszerzalności liniowej (20-100 °C) Кoefficient линейного температурного расширения (20-100 °C)	ISO 10545-8	Nepožaduje se / Not required Nie wymaga się / Не требуется	Max. 8 x 10 ⁻⁴ K ⁻¹ / Max. 8 x 10 ⁻⁴ K ⁻¹ Maks. 8 x 10 ⁻⁴ K ⁻¹ / Макс. 8 x 10 ⁻⁴ K ⁻¹	Nepožaduje se / Not required Nie wymaga się / Не требуется	Max. 8 x 10 ⁻⁴ K ⁻¹ / Max. 8 x 10 ⁻⁴ K ⁻¹ Maks. 8 x 10 ⁻⁴ K ⁻¹ / Макс. 8 x 10 ⁻⁴ K ⁻¹	Nepožaduje se / Not required Nie wymaga się / Не требуется	Max. 8 x 10 ⁻⁴ K ⁻¹ / Max. 8 x 10 ⁻⁴ K ⁻¹ Maks. 8 x 10 ⁻⁴ K ⁻¹ / Макс. 8 x 10 ⁻⁴ K ⁻¹	Nepožaduje se / Not required Nie wymaga się / Не требуется	Max. 8 x 10 ⁻⁴ K ⁻¹ / Max. 8 x 10 ⁻⁴ K ⁻¹ Maks. 8 x 10 ⁻⁴ K ⁻¹ / Макс. 8 x 10 ⁻⁴ K ⁻¹	Nepožaduje se / Not required Nie wymaga się / Не требуется	Max. 8 x 10 ⁻⁴ K ⁻¹ / Max. 8 x 10 ⁻⁴ K ⁻¹ Maks. 8 x 10 ⁻⁴ K ⁻¹ / Макс. 8 x 10 ⁻⁴ K ⁻¹	Nepožaduje se / Not required Nie wymaga się / Не требуется	Max. 8 x 10 ⁻⁴ K ⁻¹ / Max. 8 x 10 ⁻⁴ K ⁻¹ Maks. 8 x 10 ⁻⁴ K ⁻¹ / Макс. 8 x 10 ⁻⁴ K ⁻¹	Nepožaduje se / Not required Nie wymaga się / Не требуется	Max. 8 x 10 ⁻⁴ K ⁻¹ / Max. 8 x 10 ⁻⁴ K ⁻¹ Maks. 8 x 10 ⁻⁴ K ⁻¹ / Макс. 8 x 10 ⁻⁴ K ⁻¹	Nepožaduje se / Not required Nie wymaga się / Не требуется	Max. 8 x 10 ⁻⁴ K ⁻¹ / Max. 8 x 10 ⁻⁴ K ⁻¹ Maks. 8 x 10 ⁻⁴ K ⁻¹ / Макс. 8 x 10 ⁻⁴ K ⁻¹	Nepožaduje se / Not required Nie wymaga się / Не требуется								
	Odolnost proti chem. používaným v domácnosti Resistance to various chemicals used in household Odporność na chemikalia domowego użytku Устойчивость к воздействию бытовой химии	ISO 10545-13	Min. B Min. B Min. B Min. B	Min. A Min. A Min. A Min. A	Min. B Min. B Min. B 																						

Záruční podmínky | Warranty terms and conditions | Warunki gwarancji Гарантийные условия

CZ Výrobce LASSELSBERGER, s.r.o., Plzeň, poskytuje u všech svých keramických obkladových prvků
2letou záruku

na vlastnosti stanovené příslušnou normou EN 14 411:2016.

Záruka platí pouze při dodržení doporučení výrobce, správného skladování a manipulace a pro případy správného provedení stavebních a kladečských prací. Nevztahuje se na vady způsobené nevhodným zacházením, neodborným čištěním a přírodními živly (zemětřesení, povodeň, požár aj.)

Pokud odběratel obdrží výrobek, jehož vlastnosti neodpovídají sjednané jakosti, má právo výrobek reklamovat. Přitom je nutno dodržet určený postup. Každou reklamaci výrobku je nutno uplatnit neprodleně písemně u přímého dodavatele – prodejce.

U zjevných vad (rozměry, křivost, vady glazur, odstíny, záměny druhu) je nutno reklamaci uplatnit před zahájením kladečských prací na zboží v původních obalech.

EN The manufacturer, LASSELSBERGER, s.r.o. Pilsen, provides for all company's ceramic tile products
a 2-year warranty

on properties defined by the applicable standard, EN 14 411:2016.

The warranty applies subject to all manufacturer's recommendations being observed, subject to correct storage and manipulation, and subject to correctly performed building and fixing works. The warranty does not cover defects caused by unsuitable handling, incorrect cleaning and the elements of nature (earthquake, floods, fire, etc.).

If a customer receives a product whose properties do not meet the declared quality, he may submit a claim. To do so, certain procedure must be followed. A claim must be submitted forthwith in writing to the direct supplier – the dealer.

In the event of obvious defects (dimensions, warping, faulty glazing, colour shades, incorrect type), the claim must be submitted before the start of laying works, with the products in original packaging.

PL Producent LASSELSBERGER, s.r.o. Pilzno, CR udziela na wszystkie swoje ceramiczne elementy wykończeniowe
2 letniej gwarancji

na właściwości określone we właściwej normie EN 14 411:2016.

Gwarancja obowiązuje tylko pod warunkiem przestrzegania zaleceń producenta, prawidłowego magazynowania i manipulacji, oraz prawidłowego wykonania prac budowlanych i ułożenia. Nie dotyczy wad spowodowanych nieprawidłowym obchodzeniem się, nieprawidłowym czyszczeniem i siłą wyższą (trzęsienie ziemi, powódź, pożar, itp.)

Jeżeli odbiorca otrzyma wyrób, którego właściwości nie odpowiadają uzgodnionej jakości, ma prawo do reklamacji. Składając reklamację należy dotrzymać przepisanej procedury. Każdą reklamację trzeba składać niezwłocznie pisemnie u bezpośredniego dostawcy – sprzedawcy.

W razie widocznych wad (wymiarów, zakrzywienie, wady szkliwa, koloru, zamiany typów) należy składać reklamację przed rozpoczęciem układania, z towarem w oryginalnych opakowaniach.

RUS Производитель LASSELSBERGER, s.r.o., г. Пльзень, предоставляет на весь ассортимент керамических облицовочных элементов
двухлетний гарантийный срок.

Гарантия распространяется на свойства, приведенные в соответствующем стандарте EN 14 411:2016.

Гарантия действительна только при соблюдении рекомендаций производителя, правильном хранении и обращении и при условии правильного выполнения строительных и облицовочных работ. Гарантия не распространяется на дефекты, возникшие в результате неправильного обращения, неквалифицированного ухода и на повреждения, возникшие в результате стихийных бедствий (землетрясение, наводнение, пожар и т.д.).

Если покупатель приобрел товар, параметры которого не соответствуют оговоренному качеству, он вправе подать претензию. При подаче претензии необходимо соблюдать определенный порядок. Претензия должна быть оформлена в письменной форме и предъявлена напрямую поставщику или дилеру.

В случае обнаружения явных дефектов (размеры, кривизна, дефекты глазури, различие в оттенке, пересортица) необходимо предъявить претензию перед началом работ по укладке и предъявить товар в оригинальной упаковке.